

PROPLAST
FAHRZEUGBELEUCHTUNG

INNOVATIONS
2019/2020

www.proplast-online.de

Aktuelle Informationen über
PROPLAST finden Sie unter:
www.proplast-online.de





- neue Produkte
- aktuelle Messeauftritte
- detaillierte Produktinformationen
- Downloadbereich:
 - Flipkatalog
 - Videos
 - Galerie
 - Poster
 - Flyer
 - ⋮

 = Leuchtdioden
light-emitting diode

 = Lichtleitertechnik
light guide technology

 = ADR-Zulassung ("Gefahrgut")
ADR-Homologation ("dangerous goods")

 = Xenonlicht
xenonlight

 = Elektromagnetische Verträglichkeit
electromagnetic compatibility

LED Heckleuchten	LED Rear Combination Lamps	1.0	- 1.50
Heckleuchten	Rear Combination Lamps	1.51	- 1.83
Heckleuchten Anhänger	Rear Combination Lamps Trailers	1.84	- 1.111
Diverse LED Leuchten	Various LED Lamps	1.112	- 1.116
Leuchtengarnituren	Lighting Kits	1.117	- 1.118

01

LED Nebelschlußleuchten/ LED Rückfahrleuchten	LED Fog Lamps/LED Reversing Lamps	2.0	- 2.5
Nebelschlußleuchten/Rückfahrleuchten	Fog Lamps/Reversing Lamps	2.6	
LED Blinkleuchten	LED Direction Indicator Lamps	2.7	- 2.12
LED 3. Bremsleuchten	LED 3rd Stop Lamps	2.13	

02

LED Umrißleuchten	LED End Outline Marker Lamps	3.0	- 3.11
Umrißleuchten	End Outline Marker Lamps	3.12	- 3.19
LED Begrenzungsleuchten/ LED Schluß-Umrißleuchten	LED Front Position Lamps/ LED Rear Position Lamps	3.20	- 3.36
Begrenzungsleuchten/ Schluß-Umrißleuchten	Front Position Lamps/ Rear Position Lamps	3.37	- 3.38
Universal Positionsleuchten	Universal Position Lamps	3.39	

03

LED Seitenmarkierungsleuchten Verkabelte	LED Sidemarker Lamps LED Sidemarker Lamps with cable	4.0	- 4.25
LED Seitenmarkierungsleuchten Seitenmarkierungsleuchten	Sidemarker Lamps	4.23	- 4.28

04

LED Kennzeichenleuchten	LED Registration Plate Lamps	5.0	- 5.3
Kennzeichenleuchten	Registration Plate Lamps	5.4	- 5.5
LED Innenleuchten	LED Interior Lamps	5.6	- 5.25

05

LED Arbeitsscheinwerfer	LED Work Lamps	6.0	- 6.16
LED Punktscheinwerfer	LED Warning Lamps	6.17	
LED Rückfahrcheinwerfer	LED Reversing Lamps	6.18	
LED Zusatz-/Nebelscheinwerfer/ LED Tagfahrleuchten	LED Spot-/Fog Lamps/ LED Daytime Running Lights	6.19	
H3-Arbeitsscheinwerfer	H3-Work Lamps	6.20	
Nebel-/Fernscheinwerfer	Fog-/Spot Lamps		
Hauptscheinwerfer	Driving Lamps		

06

LED Kennleuchten	LED Beacons	7.0	- 7.11
Rundumkennleuchten	Rotating Beacons	7.12	- 7.13
Xenon Blitz-Kennleuchten	Xenon Beacons	7.14	
Aufsteckrohre	Pole Mount Brackets	7.15	
Optische Warnanlagen	Lightbars	7.16	- 7.20

07

Rückstrahler rund	Reflex Reflectors round	8.0	- 8.1
Rückstrahler rechteckig	Reflex Reflectors rectangular	8.2	- 8.3
Dreieckrückstrahler	Triangle Reflex Reflectors	8.4	

08

LED Kontrollgeräte	LED Control Gears	9.0	- 9.10
Blink-Modul für Seitenmarkierungsleuchten	Blink-Unit for Sidemarker Lamp	9.11	
Fahrzeugleitungen	Cable Kits	9.12	- 9.18
Steckverbinder	Connectors	9.19	- 9.21

09

Rückfahrwarner	Back Alarm Systems	10.0	- 10.1
Verteilerdosen	Junction Boxes	10.2	
Verbindungskabel	Cable System	10.3	- 10.4
Batterie Hauptschalter	Switch Isolator	10.5	
LED Module	LED Modul	10.5	
Schwingungsdämpfer	Shock Absorber	10.5	
PROPLAST Verkaufunterstützung	PROPLAST Sales Support	10.6	

10

Herstellerverzeichnis	Manufacturer List	11.0	
-----------------------	-------------------	------	--

11

Artikelnummernübersicht	Reference Numbers	12.0	- 12.5
-------------------------	-------------------	------	--------

12

LED Heckleuchten	LED Rear Combination Lamps	1.0	- 1.50
Heckleuchten	Rear Combination Lamps	1.51	- 1.83
Heckleuchten Anhänger	Rear Combination Lamps Trailers	1.84	- 1.111
Diverse LED Leuchten	Various LED Lamps	1.112	- 1.116
Leuchtengarnituren	Lighting Kits	1.117	- 1.118



LED Heckleuchte

LED Rear Combination Lamp

Typ: PRO-TRUCK 24V IP67

Funktion: 2 x LED Schlusslicht - LED Bremslicht -
 dynamische LED Blinkleuchte - LED Rückfahrleuchte -
 LED Nebelschlussleuchte - Rückstrahler
 LED Leuchtenmodule + Rückstrahler auswechselbar

Function: 2x LED Tail Lamp - LED Stop Lamp -
 sequential LED Dir. Indicator Lamp - LED Reversing Lamp -
 LED Fog Lamp - Reflex Reflector
 LED Lamp modules + reflex reflector replaceable

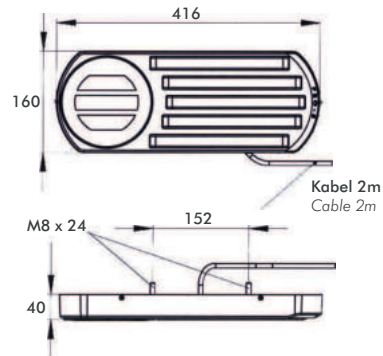
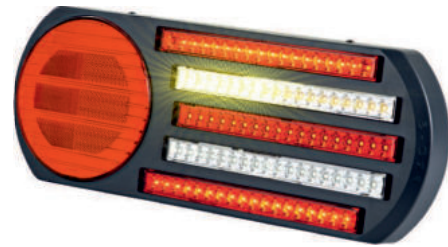

Besonderheit: dynamische Blinklichtfunktion
 Feature: sequential Direction Indicator Function

Artikel-Nr. Reference-No.	VE QTY	links left	rechts right	Kennz.- leuchte Numberplate- lamp	Beschreibung - Hersteller Referenz Specification - O.E.-No.	Anschlußsystem - Zubehör - Ersatzteile Connector - Accessories - Spare Parts
40 285 011	1	■			Ausführung mit Kabel 2,0m version with cable 2,0m	
40 285 012	1		■		Ausführung mit Kabel 2,0m version with cable 2,0m	
50 140 024 24V	1	■	■		Zentral LED Kontrollgerät überwacht die Blinkleuchte und kontrolliert die Brems-Schluss- Nebelschluss-Rückfahrleuchte LED Control Gear monitors the direction indicator lamp and is checking the stop-tail-fog- reversing lamp	siehe Seite 9.0 PRO-LCG see page 9.0
40 026 032 24V	1	■	■		LED Einsatz Brems-Schlussleuchte LED Unit Stop-Tail Lamp	PRO-CAN XL
40 026 051 24V	1	■	■		LED Einsatz dynamische Blinkleuchte LED Unit sequential Dir. Indicator Lamp	PRO-CAN XL
40 026 002 24V	1	■	■		LED Einsatz Schlussleuchte LED Unit Tail Lamp	PRO-CAN XL
40 026 503 24V	1	■	■		LED Einsatz Rückfahrleuchte LED Unit Reversing Lamp	PRO-CAN XL
40 026 022 24V	1	■	■		LED Einsatz Nebelschlussleuchte LED Unit Fog Lamp	PRO-CAN XL
20 105 504	1	■	■		Rückstrahler in brillanter Spiegeloptik Reflex Reflector in brilliant clear glass optic	PRO-T-REFLEX
40 280 112	1	■	■		Gehäuseabdeckung anthrazit Cover for housing in anthracite	

LED Heckleuchte

LED Rear Combination Lamp

Typ: PRO-CAN XL 3F SQ IP67

Funktion: LED Schlusslicht - LED Bremslicht -
dynamische LED Blinklichtfunktion

Function: LED Tail Lamp - LED Stop Lamp -
sequential LED Dir. Indicator Lamp

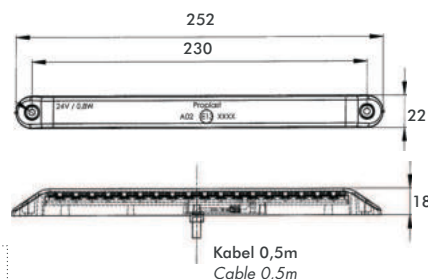

Besonderheit: dynamische Blinklichtfunktion
Feature: sequential Direction Indicator Function

Artikel-Nr. Reference-No.	VE QTY	links left	rechts right	Kennz.- leuchte Numberplate- lamp	Beschreibung - Hersteller Referenz Specification - O.E.-No.	Anschlußsystem - Zubehör - Ersatzteile Connector - Accessories - Spare Parts
40 026 672 24V	1	■	■		Ausführung Kabel 0,5m, 24V - 2,2W version cable 0,5m, 24V - 2,2W	
40 026 852 12V	1	■	■		Ausführung Kabel 0,5m, 12V - 2,2W version cable 0,5m, 12V - 2,2W	
40 026 652 24V	1	■	■		Ausführung Kabel 0,5m, 24V - 2,2W Gehäuse glasklar version cable 0,5m, 24V - 2,2W clear housing	
40 026 752 12V	1	■	■		Ausführung Kabel 0,5m, 12V - 2,2W Gehäuse glasklar version cable 0,5m, 12V - 2,2W clear housing	
50 140 012 12V	1	■	■		Zentral LED Kontrollgerät überwacht die Blinkleuchte und kontrolliert die Brems-Schluss- Nebelschluss-Rückfahrleuchte LED Control Gear monitors the direction indicator lamp and is checking the stop-tail-fog- reversing lamp	siehe Seite 9.1 PRO-LCG
50 140 024 24V	1					see page 9.1
50 141 012 12V	1				LED Kontrollgerät Blinklichtfunktion, Blinkerausfallkontrolle LED Control Gear Direction Indicator function	siehe Seite 9.9 PRO-CONTROL
50 141 024 24V	1	■	■			see page 9.9
50 141 500 12/24V	1					
50 139 012 12V	1	■	■		LED Kontrollgerät kontrolliert die 21W Funktionen, Lastwiderstand LED Control Gear monitors the 21W functions	siehe Seite 9.10 PRO-LOAD
50 139 024 24V	1					see page 9.10

LED Heckleuchte

LED Rear Combination Lamp

Typ: PRO-CAN XL 3F IP67

Funktion: LED Schlusslicht - LED Bremslicht - LED Blinklicht - Anbaugehäuse
Anbaulage horizontal oder vertikal

Function: LED Tail Lamp - LED Stop Lamp - LED Dir. Indicator Lamp - Fixation housing
Fixation horizontal or vertical

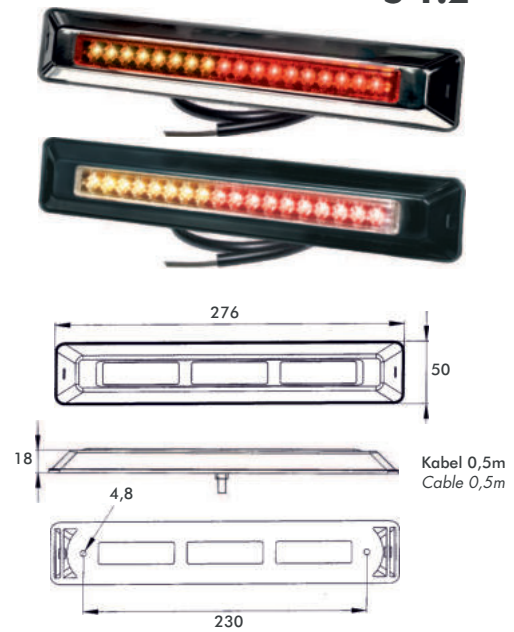

Artikel-Nr. Reference-No.	VE QTY	links left	rechts right	Kennz.- leuchte Numberplate- lamp	Beschreibung - Hersteller Referenz Specification - O.E.-No.	Anschlußsystem - Zubehör - Ersatzteile Connector - Accessories - Spare Parts
40 026 142 24V	1				Ausführung Kabel 0,5m, 2,2W, inklusive Anbaugehäuse chrom	
40 026 942 12V	1	■	■		version cable 0,5m, 2,2W, including chrome housing	
40 026 542 24V	1				Ausführung Kabel 0,5m, 2,2W, inklusive Anbaugehäuse schwarz	
40 026 642 12V	1	■	■		version cable 0,5m, 2,2W, including black housing	
40 026 052 24V	1				Ausführung Kabel 0,5m, 2,2W, inklusive Anbaugehäuse chrom, Lichtscheibe glasklar	
40 026 252 12V	1	■	■		version cable 0,5m, 2,2W, including chrome housing, clear lens	
40 026 742 24V	1				Ausführung Kabel 0,5m, 2,2W, inklusive Anbaugehäuse schwarz, Lichtscheibe glasklar	
40 026 842 12V	1	■	■		version cable 0,5m, 2,2W, including black housing, clear lens	
40 026 000 chrom/chrome	1				Anbaugehäuse für Leuchtenserie PRO-CAN XL	
40 026 004 schwarz/black	1	■	■		housing for lighting series PRO-CAN XL	
Die Farben rot, grau und weiß nur auf Anfrage erhältlich!						chrom/chrome schwarz/black
The colours red, grey and white on request only!						
					rot/red	grau/grey weiß/white

LED Heckleuchte

LED Rear Combination Lamp

Typ: PRO-CAN XL 3F IP67

Funktion: LED Schlusslicht - LED Bremslicht - LED Blinklicht
 Anbaulage horizontal oder vertikal

Function: LED Tail Lamp - LED Stop Lamp - LED Dir. Indicator Lamp
 Fixation horizontal or vertical

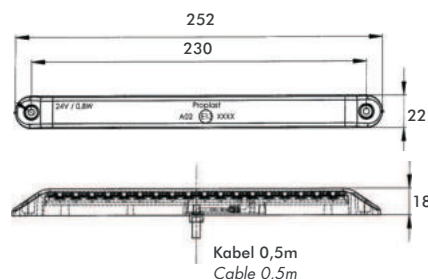

Artikel-Nr. Reference-No.	VE QTY	links left	rechts right	Kennz.- leuchte Numberplate- lamp	Beschreibung - Hersteller Referenz Specification - O.E.-No.	Anschlußsystem - Zubehör - Ersatzteile Connector - Accessories - Spare Parts
40 026 042 24V	1	■	■		Ausführung Kabel 0,5m, 24V - 2,2W version cable 0,5m, 24V - 2,2W	
40 026 242 12V	1	■	■		Ausführung Kabel 0,5m, 12V - 2,2W version cable 0,5m, 12V - 2,2W	
40 026 442 24V	1	■	■		Ausführung Kabel 0,5m, 24V - 2,2W Gehäuse glasklar version cable 0,5m, 24V - 2,2W clear housing	
40 026 342 12V	1	■	■		Ausführung Kabel 0,5m, 12V - 2,2W Gehäuse glasklar version cable 0,5m, 12V - 2,2W clear housing	
50 140 012 12V	1	■	■		Zentral LED Kontrollgerät überwacht die Blinkleuchte und kontrolliert die Brems-Schluss- Nebelschluss-Rückfahrleuchte LED Control Gear monitors the direction indicator lamp and is checking the stop-tail-fog- reversing lamp	siehe Seite 9.1 PRO-LCG
50 140 024 24V	1	■	■			see page 9.1
50 141 012 12V	1	■	■		LED Kontrollgerät Blinklichtfunktion, Blinkerausfallkontrolle LED Control Gear Direction Indicator function	siehe Seite 9.10 PRO-CONTROL
50 141 024 24V	1	■	■			see page 9.10
50 139 012 12V	1	■	■		LED Kontrollgerät kontrolliert die 21W Funktionen, Lastwiderstand LED Control Gear monitors the 21W functions	siehe Seite 9.10 PRO-LOAD
50 139 024 24V	1	■	■			see page 9.10



LED Heckleuchte

LED Rear Combination Lamp

Typ: PRO-SPACE 3F IP6K9K 12/24V

Funktion: LED Schlusslicht - LED Bremslicht - LED Blinklicht
Anbaulage horizontal oder vertikal



Function: LED Tail Lamp - LED Stop Lamp - LED Dir. Indicator Lamp
Fixation horizontal or vertical

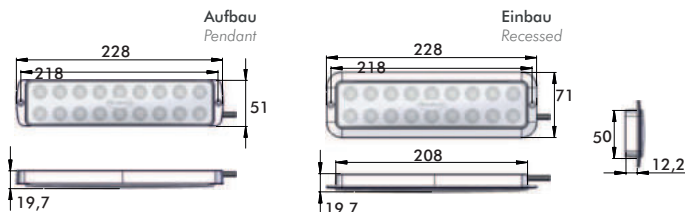

Artikel-Nr. Reference-No.	VE QTY	links left	rechts right	Kennz.- leuchte Numberplate- lamp	Beschreibung - Hersteller Referenz Specification - O.E.-No.	Anschlußsystem - Zubehör - Ersatzteile Connector - Accessories - Spare Parts
40 047 012	1	■	■		Ausführung Kabel 0,5m, Aufbauversion <i>version cable 0,5m, pendant version</i>	
40 047 512	1	■	■		Ausführung Kabel 0,5m, Einbauversion <i>version cable 0,5m, recessed version</i>	
50 140 012 12V	1	■	■		Zentral LED Kontrollgerät überwacht die Blinkleuchte und kontrolliert die Brems-Schluss- Nebelschluss-Rückfahrleuchte <i>LED Control Gear monitors the direction indicator lamp and is checking the stop-tail-fog- reversing lamp</i>	PRO-LCG siehe Seite 9.1
50 140 024 24V	1					PRO-CONTROL siehe Seite 9.9
50 141 012 12V	1				LED Kontrollgerät Blinklichtfunktion, Blinkerausfallkontrolle <i>LED Control Gear Direction Indicator function</i>	PRO-LOAD siehe Seite 9.10
50 141 024 24V	1	■	■			
50 141 500 12/24V	1					
50 139 012 12V	1	■	■		LED Kontrollgerät kontrolliert die 21W Funktionen, Lastwiderstand <i>LED Control Gear monitors the 21W functions</i>	PRO-LOAD siehe Seite 9.10
50 139 024 24V	1					
50 125 012 12V	1	■	■		LED Kontrollgerät Schlusslichtfunktion Lastwiderstand <i>LED Control Gear Tail Light function</i>	PRO-LOAD siehe Seite 9.10
50 125 000 24V	1					

LED Heckleuchte

LED Rear Combination Lamp

Typ: PRO-SPACE 3F SQ IP6K9K 12/24VFunktion: LED Schlusslicht - LED Bremslicht -
dynamische LED Blinklichtfunktion

Aufbau- / Einbauversion

Function: LED Tail Lamp - LED Stop Lamp -
sequential LED Dir. Indicator Lamp

Pendant- / Recessed Version

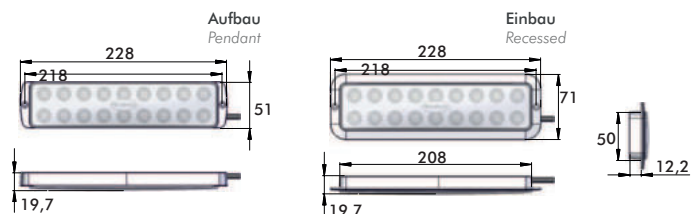

Artikel-Nr. Reference-No.	VE QTY	links left	rechts right	Kennz.- leuchte Numberplate- lamp	Beschreibung - Hersteller Referenz Specification - O.E.-No.	Anschlußsystem - Zubehör - Ersatzteile Connector - Accessories - Spare Parts
40 047 611	1	■			Ausführung Aufbauversion Kabel 0,5m <i>pendant version cable 0,5m</i>	
40 047 612	1		■		Ausführung Aufbauversion Kabel 0,5m <i>pendant version cable 0,5m</i>	
40 047 711	1	■			Ausführung Einbauversion Kabel 0,5m <i>recessed version cable 0,5m</i>	
40 047 712	1		■		Ausführung Einbauversion Kabel 0,5m <i>recessed version cable 0,5m</i>	
50 140 012 12V	1	■	■		Zentral LED Kontrollgerät überwacht die Blinkleuchte und kontrolliert die Brems-Schluss- Nebelschluss-Rückfahrleuchte <i>LED Control Gear monitors the direction indicator lamp and is checking the stop-tail-fog- reversing lamp</i>	siehe Seite 9.1 PRO-LCG
50 140 024 24V	1					see page 9.1
50 141 012 12V	1	■			LED Kontrollgerät Blinklichtfunktion, Blinkerausfallkontrolle <i>LED Control Gear Direction Indicator function</i>	siehe Seite 9.9 PRO-CONTROL
50 141 024 24V	1	■	■			see page 9.9
50 141 500 12/24V	1					
50 139 012 12V	1	■	■		LED Kontrollgerät kontrolliert die 21W Funktionen, Lastwiderstand <i>LED Control Gear monitors the 21W functions</i>	PRO-LOAD
50 139 024 24V	1					see page 9.10

LED Heckleuchte

LED Rear Combination Lamp

Typ: PRO-STRIPE ECE II IP6K9K
Funktion: LED Schlusslicht - LED Bremslicht - LED Blinklicht
 Anbau frei drehbar um die Bezugsachse

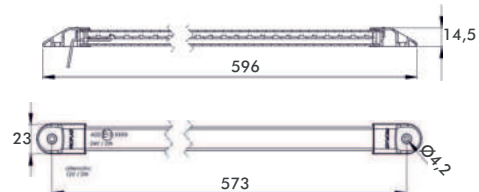
 Function: LED Tail Lamp - LED Stop Lamp - LED Dir. Indicator Lamp
 mounting free rotated about the reference axis

Artikel-Nr. Reference-No.	VE QTY	links left	rechts right	Kennz.- leuchte Numberplate- lamp	Beschreibung - Hersteller Referenz Specification - O.E.-No.	Anschlußsystem - Zubehör - Ersatzteile Connector - Accessories - Spare Parts
40 052 032 24V	1	■	■		Ausführung Kabel 0,5m version cable 0,5m	
40 052 232 12V	1	■	■		Ausführung Kabel 0,5m version cable 0,5m	
40 052 022 24V	1	■	■		Komb. LED Nebelschluss-/ Rückfahrleuchte combined LED Fog-/ Reversing Lamp	siehe Seite 2.4 see page 2.4
40 052 222 12V	1	■	■		Komb. LED Nebelschluss-/ Rückfahrleuchte combined LED Fog-/ Reversing Lamp	siehe Seite 2.4 see page 2.4
50 140 012 12V	1	■	■		Zentral LED Kontrollgerät überwacht die Blinkleuchte und kontrolliert die Brems-Schluss- Nebelschluss-Rückfahrleuchte LED Control Gear monitors the direction indicator lamp and is checking the stop-tail-fog- reversing lamp	siehe Seite 9.1 see page 9.1
50 140 024 24V	1					
50 141 012 12V	1				LED Kontrollgerät Blinklichtfunktion, Blinkerausfallkontrolle LED Control Gear Direction Indicator function	siehe Seite 9.9 see page 9.9
50 141 024 24V	1	■	■			
50 141 500 12/24V	1					
50 139 012 12V	1	■	■		LED Kontrollgerät kontrolliert die 21W Funktionen, Lastwiderstand LED Control Gear monitors the 21W functions	siehe Seite 9.10 see page 9.10
50 139 024 24V	1	■	■			

LED Heckleuchte

LED Rear Combination Lamp

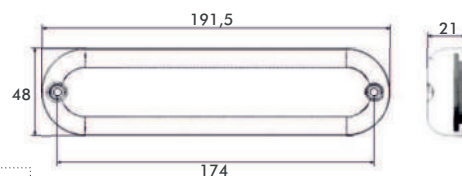
Typ: PRO-ROD 12/24V IP6K9KFunktion: LED Schlusslicht - LED Bremslicht -
dynamische LED BlinklichtfunktionFunction: LED Tail Lamp - LED Stop Lamp -
sequential LED Dir. Indicator LampBesonderheit: dynamische Blinklichtfunktion
Feature: sequential Direction Indicator Function

Artikel-Nr. Reference-No.	VE QTY	links left	rechts right	Kennz.- leuchte Numberplate- lamp	Beschreibung - Hersteller Referenz Specification - O.E.-No.	Anschlußsystem - Zubehör - Ersatzteile Connector - Accessories - Spare Parts
40 244 001	1	■	■		LED Schlusslicht in Lichtleitertechnik Ausführung Kabel 0,5m LED Tail Lamp in <i>Light guide technology</i> version cable 0,5m	
40 244 501	1	■	■		LED Schlusslicht in Lichtleitertechnik Ausführung Kabel 5,0m LED Tail Lamp in <i>Light guide technology</i> version cable 5,0m	
50 140 012 12V	1	■	■		Zentral LED Kontrollgerät überwacht die Blinkleuchte und kontrolliert die Brems-Schluss- Nebelschluss-Rückfahrleuchte LED Control Gear monitors the direction indicator lamp and is checking the stop-tail-fog- reversing lamp	siehe Seite 9.1 PRO-LCG
50 140 024 24V	1					see page 9.1
50 141 012 12V	1				LED Kontrollgerät Blinklichtfunktion, Blinkerausfallkontrolle LED Control Gear Direction Indicator function	siehe Seite 9.9 PRO-CONTROL
50 141 024 24V	1	■	■			see page 9.9
50 141 500 12/24V	1					
50 139 012 12V	1	■	■		LED Kontrollgerät kontrolliert die 21W Funktionen, Lastwiderstand LED Control Gear monitors the 21W functions	siehe Seite 9.10 PRO-LOAD
50 139 024 24V	1					see page 9.10
50 125 012 12V	1	■	■		LED Kontrollgerät Schlusslichtfunktion Lastwiderstand LED Control Gear Tail Light function	siehe Seite 9.10
50 125 000 24V	1					see page 9.10

LED Heckleuchte

LED Rear Combination Lamp

Typ: PRO-RAIL 3F 12V IP6K9K

Funktion: LED Schlusslicht - LED Bremslicht - LED Blinklicht -
Rückstrahler
integr. 12V Blinkerausfallkontrolle
Anbaulage horizontal oder vertikal

Function: LED Tail Lamp - LED Stop Lamp - LED Dir. Indicator Lamp -
Reflex Reflector
integr. 12V Flasher control unit
Fixation horizontal or vertical

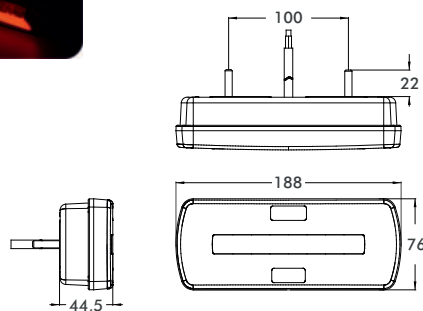
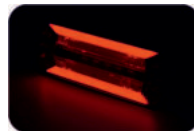

Artikel-Nr. Reference-No.	VE QTY	links left	rechts right	Kennz.- leuchte Numberplate- lamp	Beschreibung - Hersteller Referenz Specification - O.E.-No.	Anschlußsystem - Zubehör - Ersatzteile Connector - Accessories - Spare Parts
40 258 012 12V	1	■	■		3 Funktionen LED Schlusslicht in Lichtleitertechnik, Kabel 2,0m, integr. 12V Blinkerausfallkontrolle 3 functions LED Tail Lamp in Light guide technology, cable 2,0m, integr. 12V flasher control unit	
50 139 012 12V	1	■	■		LED Kontrollgerät kontrolliert die 21W Funktionen, Lastwiderstand LED Control Gear monitors the 21W functions	siehe Seite 9.10 PRO-LOAD  see page 9.10
50 125 012 12V	1	■	■		LED Kontrollgerät Schlusslichtfunktion Lastwiderstand LED Control Gear Tail Light function	siehe Seite 9.10  see page 9.10

LED Heckleuchte

LED Rear Combination Lamp

Typ: PRO-RAIL 5F 12/24V IP6K9K

Funktion: LED Schlusslicht - LED Bremslicht - LED Blinklicht -
LED Rückfahrleuchte - LED Nebelschlussleuchte
Rückstrahler
Opt. 12V Blinkerausfallkontrolle
Anbaulage horizontal oder vertikal

Function: LED Tail Lamp - LED Stop Lamp - LED Dir. Indicator Lamp -
LED Reversing Lamp - LED Fog Lamp - Reflex Reflector
Opt. 12V Flasher control unit
Fixation horizontal or vertical

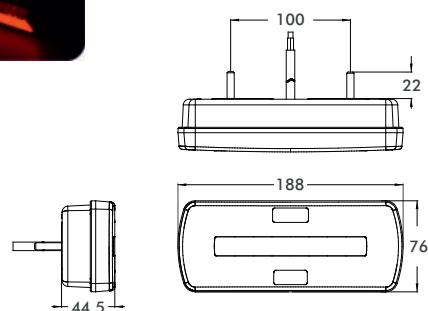
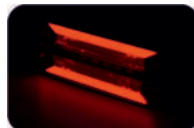

Artikel-Nr. Reference-No.	VE QTY	links left	rechts right	Kennz.- leuchte Numberplate- lamp	Beschreibung - Hersteller Referenz Specification - O.E.-No.	Anschlußsystem - Zubehör - Ersatzteile Connector - Accessories - Spare Parts
40 260 001 12/24V	1	■	■		5 Funktionen LED Schlusslicht in Lichtleitertechnik, Kabel 2,0m 5 functions LED Tail Lamp in Light guide technology, cable 2,0m	
40 260 012 12V	1	■	■		5 Funktionen LED Schlusslicht in Lichtleitertechnik, Kabel 2,0m, integr. 12V Blinkerausfallkontrolle 5 functions LED Tail Lamp in Light guide technology, cable 2,0m, integr. 12V flasher control unit	
50 140 012 12V	1	■	■		Zentral LED Kontrollgerät überwacht die Blinkleuchte und kontrolliert die Brems-Schluss- Nebelschluss-Rückfahrleuchte LED Control Gear monitors the direction indicator lamp and is checking the stop-tail-fog- reversing lamp	siehe Seite 9.1 PRO-LCG 
50 140 024 24V	1					see page 9.1
50 141 012 12V	1				LED Kontrollgerät Blinklichtfunktion, Blinkerausfallkontrolle LED Control Gear Direction Indicator function	siehe Seite 9.9 PRO-CONTROL 
50 141 024 24V	1	■	■			see page 9.9
50 141 500 12/24V	1					
50 139 012 12V	1	■	■		LED Kontrollgerät kontrolliert die 21W Funktionen, Lastwiderstand LED Control Gear monitors the 21W functions	siehe Seite 9.10 PRO-LOAD 
50 139 024 24V	1					see page 9.10
50 125 012 12V	1	■	■		LED Kontrollgerät Schlusslichtfunktion Lastwiderstand LED Control Gear Tail Light function	siehe Seite 9.10 
50 125 000 24V	1					see page 9.10

LED Heckleuchte

LED Rear Combination Lamp

Typ: PRO-ROAD LG 5F 12/24V IP6K9K
Funktion: LED Schlusslicht - LED Bremslicht - LED Blinklicht -
 LED Rückfahrlicht - LED Nebelschlusslicht -
 Rückstrahler
 Anbaulage horizontal oder vertikal

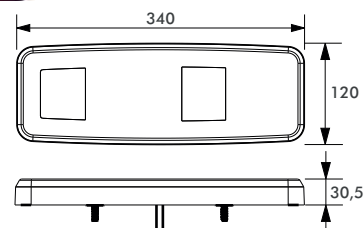
Function: LED Tail Lamp - LED Stop Lamp - LED Dir. Indicator Lamp -
 LED Reversing Lamp - LED Fog Lamp - Reflex Reflector
 Fixation horizontal or vertical

Artikel-Nr. Reference-No.	VE QTY	links left	rechts right	Kennz.- leuchte Numberplate- lamp	Beschreibung - Hersteller Referenz Specification - O.E.-No.	Anschlußsystem - Zubehör - Ersatzteile Connector - Accessories - Spare Parts
40 703 012	1	■	■		LED Schlusslicht in Lichtleitertechnik Ausführung Kabel 0,5m <i>LED Tail Lamp in Light guide technology version cable 0,5m</i>	
40 703 212	1	■	■		LED Schlusslicht in Lichtleitertechnik Ausführung 7-polig AMP Stecker <i>LED Tail Lamp in Light guide technology version 7-pole AMP connector</i>	
50 071 100	1	■	■		Anschlußstecker für Ausführung 40 703 212 <i>Connector for version 40 703 212</i>	
50 140 012 12V	1	■	■		Zentral LED Kontrollgerät überwacht die Blinkleuchte und kontrolliert die Brems-Schluss- Nebelschluss-Rückfahrleuchte <i>LED Control Gear monitors the direction indicator lamp and is checking the stop-tail-fog- reversing lamp</i>	siehe Seite 9.1 PRO-LCG
50 140 024 24V	1					see page 9.1
50 141 012 12V	1				LED Kontrollgerät Blinklichtfunktion, Blinkerausfallkontrolle <i>LED Control Gear Direction Indicator function</i>	siehe Seite 9.9 PRO-CONTROL
50 141 024 24V	1	■	■			see page 9.9
50 141 500 12/24V	1					
50 139 012 12V	1	■	■		LED Kontrollgerät kontrolliert die 21W Funktionen, Lastwiderstand <i>LED Control Gear monitors the 21W functions</i>	siehe Seite 9.10 PRO-LOAD
50 139 024 24V	1	■	■			see page 9.10
50 125 012 12V	1	■	■		LED Kontrollgerät Schlusslichtfunktion Lastwiderstand <i>LED Control Gear Tail Light function</i>	siehe Seite 9.10
50 125 000 24V	1					see page 9.10

LED Heckleuchte

LED Rear Combination Lamp



Typ: PRO-ROAD LG 3F 12/24V IP6K9K

Funktion: LED Schlusslicht - LED Bremslicht - LED Blinklicht -
Rückstrahler
Anbaulage horizontal oder vertikal



Function: LED Tail Lamp - LED Stop Lamp - LED Dir. Indicator Lamp -
Reflex Reflector
Fixation horizontal or vertical

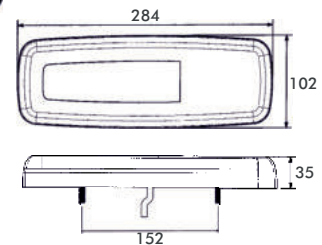

Artikel-Nr. Reference-No.	VE QTY	links left	rechts right	Kennz.- leuchte Numberplate- lamp	Beschreibung - Hersteller Referenz Specification - O.E.-No.	Anschlußsystem - Zubehör - Ersatzteile Connector - Accessories - Spare Parts
40 294 012	1	■	■		LED Schlusslicht in Lichtleitertechnik Ausführung Kabel 0,5m <i>LED Tail Lamp in Light guide technology version cable 0,5m</i>	
40 294 212	1	■	■		LED Schlusslicht in Lichtleitertechnik Ausführung 5-polig Stecker <i>LED Tail Lamp in Light guide technology version 5-pole connector</i>	
50 047 000	1	■	■		Anschlußstecker für Ausführung 40 294 212 <i>Connector for version 40 294 212</i>	
40 057 502	1	■	■	■	Komb. LED Nebelschluss-/ Rückfahrleuchte mit seitlicher Kennzeichenleuchte <i>combined LED Fog-/ Reversing Lamp with lateral Numberplate Lamp</i>	siehe Seite 2.3 see page 2.3
50 140 012 12V	1	■	■		Zentral LED Kontrollgerät überwacht die Blinkleuchte und kontrolliert die Brems-Schluss- Nebelschluss-Rückfahrleuchte <i>LED Control Gear monitors the direction indicator lamp and is checking the stop-tail-fog- reversing lamp</i>	siehe Seite 9.1 PRO-LCG see page 9.1
50 140 024 24V	1					
50 141 012 12V	1				LED Kontrollgerät Blinklichtfunktion, Blinkerausfallkontrolle <i>LED Control Gear Direction Indicator function</i>	siehe Seite 9.9 PRO-CONTROL see page 9.9
50 141 024 24V	1	■	■			
50 141 500 12/24V	1					
50 139 012 12V	1	■	■		LED Kontrollgerät kontrolliert die 21W Funktionen, Lastwiderstand <i>LED Control Gear monitors the 21W functions</i>	siehe Seite 9.10 PRO-LOAD see page 9.10
50 139 024 24V	1					

LED Heckleuchte

LED Rear Combination Lamp

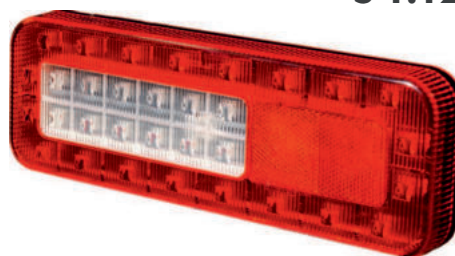

Typ: PRO-ROAD 12/24V IP6K9K

Funktion: LED Schlusslicht - LED Bremslicht - LED Blinklicht - Rückstrahler

Function: LED Tail Lamp - LED Stop Lamp - LED Dir. Indicator Lamp - Reflex Reflector

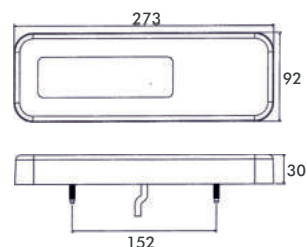

Artikel-Nr. Reference-No.	VE QTY	links left	rechts right	Kennz.- leuchte Numberplate- lamp	Beschreibung - Hersteller Referenz Specification - O.E.-No.	Anschlußsystem - Zubehör - Ersatzteile Connector - Accessories - Spare Parts
40 288 012	1	■	■		Ausführung Kabel 0,5m version cable 0,5m	
40 288 212	1	■	■		Ausführung Bajonettstecker 5-polig Version with connector 5-poles	
50 047 000	1	■	■		Anschlußstecker für Ausführung 40 288 212 Connector for version 40 288 212	
40 288 002	1	■	■		Komb. LED Nebelschluss-/Rückfahrleuchte combined LED Fog-/Reversing Lamp	siehe Seite 2.3 see page 2.3
50 140 012 12V	1	■	■		Zentral LED Kontrollgerät überwacht die Blinkleuchte und kontrolliert die Brems-Schluss-Nebelschluss-Rückfahrleuchte LED Control Gear monitors the direction indicator lamp and is checking the stop-tail-fog-reversing lamp	siehe Seite 9.1 PRO-LCG
50 140 024 24V	1					
50 141 012 12V	1				LED Kontrollgerät Blinklichtfunktion, Blinkerausfallkontrolle	siehe Seite 9.9 PRO-CONTROL
50 141 024 24V	1	■	■		LED Control Gear Direction Indicator function	
50 141 500 12/24V	1					
50 139 012 12V	1	■	■		LED Kontrollgerät kontrolliert die 21W Funktionen, Lastwiderstand	siehe Seite 9.10 PRO-LOAD
50 139 024 24V	1				LED Control Gear monitors the 21W functions	

LED Heckleuchte

LED Rear Combination Lamp



Typ: PRO-M-ROAD 12/24V IP6K9K

Funktion: LED Schlusslicht - LED Bremslicht - LED Blinklicht

Function: LED Tail Lamp - LED Stop Lamp - LED Dir. Indicator Lamp

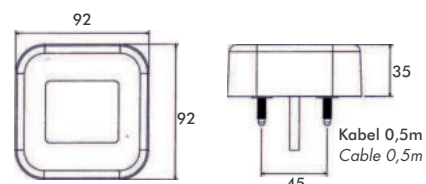

Artikel-Nr. Reference-No.	VE QTY	links left	rechts right	Kennz.- leuchte Numberplate- lamp	Beschreibung - Hersteller Referenz Specification - O.E.-No.	Anschlußsystem - Zubehör - Ersatzteile Connector - Accessories - Spare Parts
40 288 001	1	■	■		Ausführung Kabel 0,5m version cable 0,5m	
40 288 201	1	■	■		Ausführung Kabel 0,2m + Bajonettstecker 5-polig Version with cable 0,2m + connector 5-poles	
50 047 000	1	■	■		Anschlußstecker für Ausführung 40 288 201 Connector for version 40 288 201	
40 288 002	1	■	■		Komb. LED Nebelschluss-/ Rückfahrleuchte combined LED Fog-/ Reversing Lamp	siehe Seite 2.3 see page 2.3
50 140 012 12V	1	■	■		Zentral LED Kontrollgerät überwacht die Blinkleuchte und kontrolliert die Brems-Schluss- Nebelschluss-Rückfahrleuchte LED Control Gear monitors the direction indicator lamp and is checking the stop-tail-fog- reversing lamp	siehe Seite 9.1 PRO-LCG
50 140 024 24V	1					see page 9.1
50 141 012 12V	1				LED Kontrollgerät Blinklichtfunktion, Blinkerausfallkontrolle LED Control Gear Direction Indicator function	siehe Seite 9.9 PRO-CONTROL
50 141 024 24V	1	■	■			see page 9.9
50 141 500 12/24V	1					
50 139 012 12V	1	■	■		LED Kontrollgerät kontrolliert die 21W Funktionen, Lastwiderstand LED Control Gear monitors the 21W functions	siehe Seite 9.10 PRO-LOAD
50 139 024 24V	1					see page 9.10

LED Heckleuchte

LED Rear Combination Lamp

Typ: PRO-SQUARE LG 12/24V IP6K9K

Funktion: LED Schlusslicht - LED Bremslicht



Function: LED Tail Lamp - LED Stop Lamp

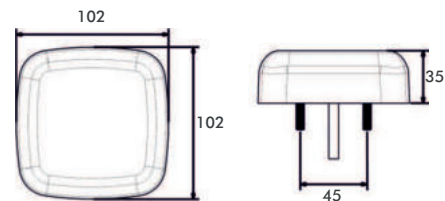

Artikel-Nr. Reference-No.	VE QTY	links left	rechts right	Kennz.- leuchte Numberplate- lamp	Beschreibung - Hersteller Referenz Specification - O.E.-No.	Anschlußsystem - Zubehör - Ersatzteile Connector - Accessories - Spare Parts
40 057 032	1	■	■		LED Schlusslicht in Lichtleitertechnik Ausführung Kabel 0,5m LED Tail Lamp in <i>Light guide technology</i> version cable 0,5m	
40 057 001	1	■	■		LED Blinkleuchte LED Dir. Indicator Lamp	
40 057 002	1	■	■		Komb. LED Nebelschluss-/ Rückfahrleuchte combined LED Fog-/ Reversing Lamp	
40 057 502	1	■	■	■ seitlich/ lateral	LED Nebelschluss-/Rückfahr- leuchte mit Kennzeichenleuchte LED Fog-/Reversing Lamp with Numberplate Lamp	
40 057 911	1	■	■		vordere LED Blink-/ Positionsleuchte front LED Dir. Indicator-/ Position Lamp	
50 140 012 12V	1	■	■		Zentral LED Kontrollgerät überwacht die Blinkleuchte und kontrolliert die Brems-Schluss- Nebelschluss-Rückfahrleuchte LED Control Gear monitors the direction indicator lamp and is checking the stop-tail-fog- reversing lamp	siehe Seite 9.1 PRO-LCG
50 140 024 24V	1					see page 9.1
50 141 012 12V	1	■	■		LED Kontrollgerät Blinklichtfunktion, Blinkerausfallkontrolle LED Control Gear Direction Indicator function	siehe Seite 9.9 PRO-CONTROL
50 141 024 24V	1					see page 9.9
50 141 500 12/24V	1					



LED Heckleuchte

LED Rear Combination Lamp



Typ: PRO-SQUARE 3F 12V

Funktion: LED Schlusslicht - LED Bremslicht - LED Blinklicht

integrierte Blinkerausfallkontrolle 12V

Function: LED Tail Lamp - LED Stop Lamp

integrated flasher control unit 12V

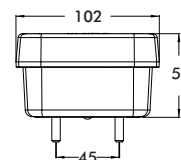
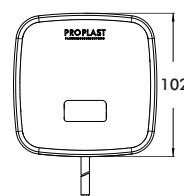

Artikel-Nr. Reference-No.	VE QTY	links left	rechts right	Kennz.- leuchte Numberplate- lamp	Beschreibung - Hersteller Referenz Specification - O.E.-No.	Anschlußsystem - Zubehör - Ersatzteile Connector - Accessories - Spare Parts
40 057 012 12V	1	■	■		LED Schlusslicht in Lichtleitertechnik Ausführung Kabel 1,0m <i>LED Tail Lamp in Light guide technology version cable 1,0m</i>	
40 057 013 12V	1	■	■	■	LED Schlusslicht in Lichtleitertechnik Ausführung Kabel 1,0m <i>LED Tail Lamp in Light guide technology version cable 1,0m</i>	
40 057 212 12V	1	■	■		LED Schlusslicht in Lichtleitertechnik Ausführung Kabel 1,0m mit 5-pol. Bajonettstecker <i>LED Tail Lamp in Light guide technology version cable 1,0m with 5-pol. bajonett connector</i>	
40 057 213 12V	1	■	■	■	LED Schlusslicht in Lichtleitertechnik Ausführung Kabel 1,0m mit 5-pol. Bajonettstecker <i>LED Tail Lamp in Light guide technology version cable 1,0m with 5-pol. bajonett connector</i>	

Anschlussmöglichkeit mit Kabel-Kit:
Fitting possibilities with Cable-kit:
Plug 'n Play PRO-SQUARE 3F

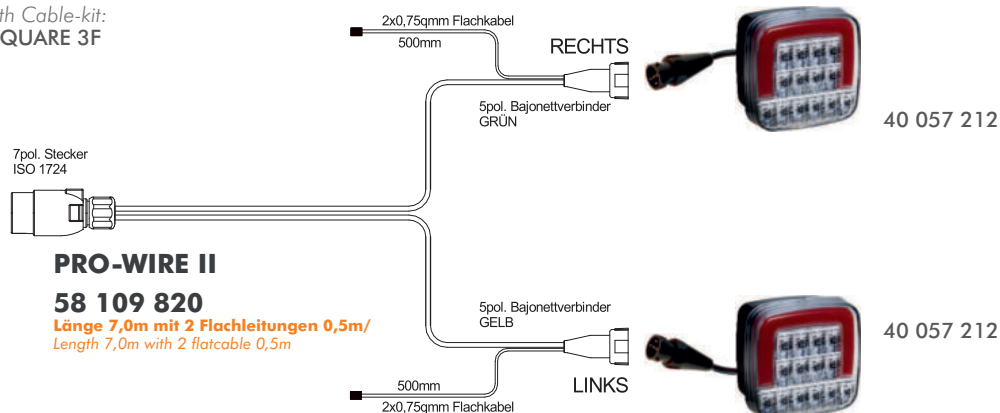

LED Heckleuchte

LED Rear Combination Lamp

Typ: PRO-AGRILED 10-30V

Funktion: LED Schlusslicht - LED Bremslicht - LED Blinklicht - Rückstrahler



Function: LED Tail Lamp - LED Stop Lamp - LED Dir. Indicator Lamp - Reflex Reflector

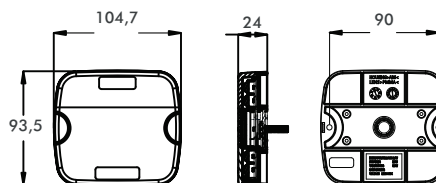

Artikel-Nr. Reference-No.	VE QTY	links left	rechts right	Kennz.- leuchte Numberplate- lamp	Beschreibung - Hersteller Referenz Specification - O.E.-No.	Anschlußsystem - Zubehör - Ersatzteile Connector - Accessories - Spare Parts
40 055 001	1	■	■		Ausführung Kabel 0,5m <i>version cable 0,5m</i>	
40 055 003	1	■	■	■	Ausführung Kabel 0,5m <i>version cable 0,5m</i>	
40 055 201	1	■	■		Ausführung Kabel 0,5m + 5-polig Bajonettstecker <i>version cable 0,5m + 5-pole bayonet connector</i>	
40 055 203	1	■	■	■	Ausführung Kabel 0,5m + 5-polig Bajonettstecker <i>version cable 0,5m + 5-pole bayonet connector</i>	

Anschlussmöglichkeit mit LED Kontrollgerät:
Fitting possibilities with LED Control Gear:
Plug 'n Play PRO-AGRILED

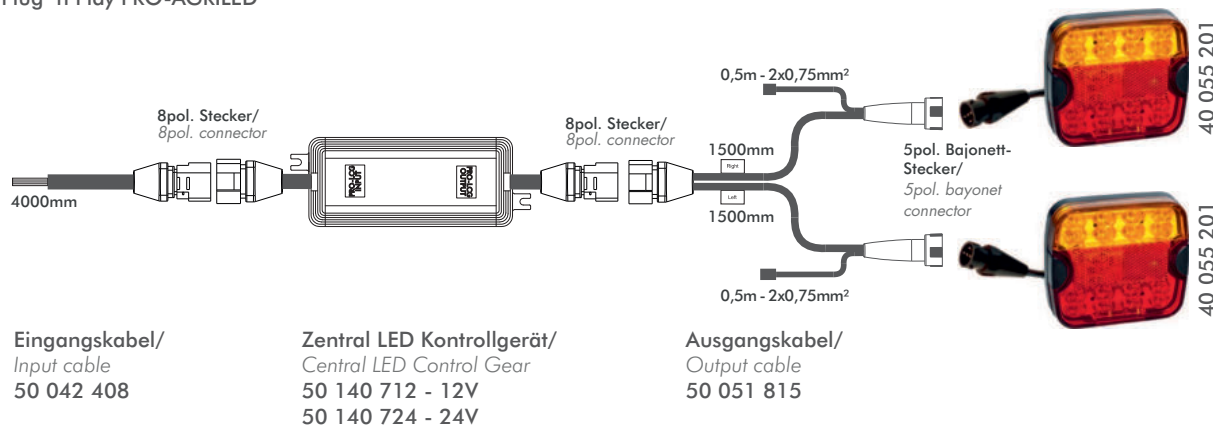



LED Heckleuchte

LED Rear Combination Lamp



Typ: PRO-AGRILED II 12V

Funktion: LED Schlusslicht - LED Bremslicht - LED Blinklicht - Rückstrahler
integrierte Blinkerausfallkontrolle

Function: LED Tail Lamp - LED Stop Lamp - LED Dir. Indicator Lamp - Reflex Reflector
integrated flasher control unit

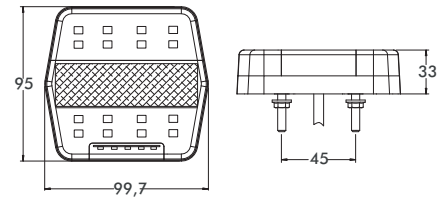

Artikel-Nr. Reference-No.	VE QTY	links left	rechts right	Kennz.- leuchte Numberplate- lamp	Beschreibung - Hersteller Referenz Specification - O.E.-No.	Anschlußsystem - Zubehör - Ersatzteile Connector - Accessories - Spare Parts
40 059 001	1	■	■		Ausführung Kabel 1,0m <i>version cable 1,0m</i>	
40 059 003	1	■	■	■	Ausführung Kabel 1,0m <i>version cable 1,0m</i>	
40 059 201	1	■	■		Ausführung Kabel 1,0m + 5-polig Bajonettstecker <i>version cable 1,0m + 5-pole bayonet connector</i>	
40 059 203	1	■	■	■	Ausführung Kabel 1,0m + 5-polig Bajonettstecker <i>version cable 1,0m + 5-pole bayonet connector</i>	

Anschlussmöglichkeit mit Kabel-Kit:
Fitting possibilities with Cable-kit:
Plug 'n Play PRO-AGRILED II

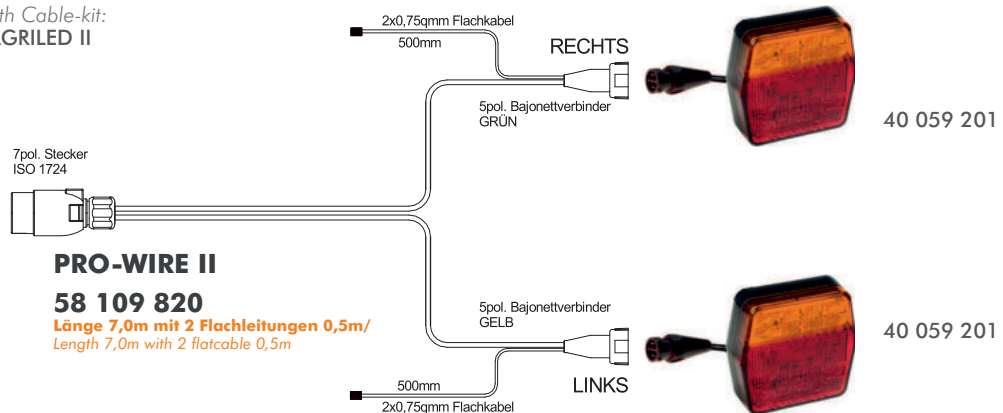

LED Heckleuchte

LED Rear Combination Lamp

Typ: PRO-BOX 12/24V IP6K9K

Funktion: LED Schlusslicht - LED Bremslicht - LED Blinklicht - Rückstrahler

Function: LED Tail Lamp - LED Stop Lamp - LED Dir. Indicator Lamp - Reflex Reflector

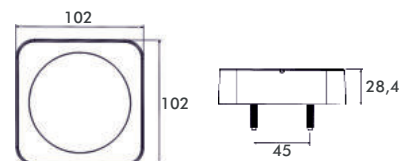

Artikel-Nr. Reference-No.	VE QTY	links left	rechts right	Kennz.- leuchte Numberplate- lamp	Beschreibung - Hersteller Referenz Specification - O.E.-No.	Anschlußsystem - Zubehör - Ersatzteile Connector - Accessories - Spare Parts
40 282 012	1	■	■		Ausführung Kabel 0,5m <i>version cable 0,5m</i>	
40 282 013	1	■	■	■ unten/ below	Ausführung Kabel 0,5m <i>version cable 0,5m</i>	
40 282 014	1	■	■	■ seitlich/ lateral	Ausführung Kabel 0,5m <i>version cable 0,5m</i>	
40 282 212	1	■	■		Ausführung Kabel 0,5m + Anschlusstecker 5-polig, <i>Version with cable 0,5m + connector 5-poles,</i>	
50 140 012 12V	1	■	■		Zentral LED Kontrollgerät überwacht die Blinkleuchte und kontrolliert die Brems-Schluss- Nebelschluss-Rückfahrleuchte <i>LED Control Gear monitors the direction indicator lamp and is checking the stop-tail-fog- reversing lamp</i>	siehe Seite 9.1 PRO-LCG
50 140 024 24V	1					see page 9.1
50 140 512 12V	1	■			LED Kontrollgerät überwacht die Blinkleuchte und kontrolliert die Brems-Schluss-Nebelschluss- Rückfahrleuchte, 5pol. Bajonett <i>LED Control Gear monitors the direction indicator lamp and is checking the stop-tail-fog- reversing lamp, 5pol. bayonet</i>	siehe Seite 9.0 PRO-LCG-ECO
50 140 513 12V	1		■			see page 9.0
50 141 212 12V	1	■	■		Vorverkabeltes LED Über- wachungkit Blinklichtfunktion, Blinkerausfallkontrolle Kabel 0,3m + 5-pol. Stecker <i>Pre-assembled LED Control Gear monitors Dir. Indicator function, cable 0,3m + 5-pole con.</i>	siehe Seite 9.9 PRO-CONTROL
						see page 9.9

LED Heckleuchte

LED Rear Combination Lamp

Typ: 3-Kammerleuchte 12/24V IP6K9K
Funktion: LED Schlusslicht - LED Bremslicht - LED Blinklicht - Rückstrahler

Function: LED Tail Lamp - LED Stop Lamp - LED Dir. Indicator Lamp - Reflex Reflector

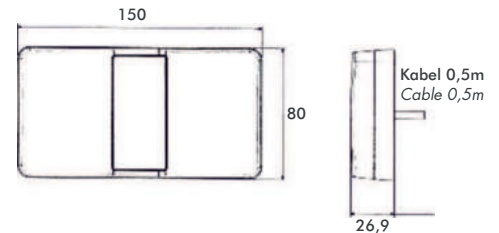

Artikel-Nr. Reference-No.	VE QTY	links left	rechts right	Kennz.- leuchte Numberplate- lamp	Beschreibung - Hersteller Referenz Specification - O.E.-No.	Anschlußsystem - Zubehör - Ersatzteile Connector - Accessories - Spare Parts
40 277 012	1	■	■		Ausführung Kabel 0,5m version cable 0,5m	
50 140 012 12V	1	■	■		Zentral LED Kontrollgerät überwacht die Blinkleuchte und kontrolliert die Brems-Schluss- Nebelschluss-Rückfahrleuchte LED Control Gear monitors the direction indicator lamp and is checking the stop-tail-fog- reversing lamp	siehe Seite 9.1 PRO-LCG
50 140 024 24V	1	■	■			see page 9.1
50 141 012 12V	1	■	■		LED Kontrollgerät Blinklichtfunktion, Blinkerausfallkontrolle LED Control Gear Direction Indicator function	siehe Seite 9.9 PRO-CONTROL
50 141 024 24V	1	■	■			see page 9.9
50 141 500 12/24V	1	■	■			
50 139 012 12V	1	■	■		LED Kontrollgerät kontrolliert die 21W Funktionen, Lastwiderstand LED Control Gear monitors the 21W functions	siehe Seite 9.10 PRO-LOAD
50 139 024 24V	1	■	■			see page 9.10
50 125 012 12V	1	■	■		LED Kontrollgerät Schlusslichtfunktion Lastwiderstand LED Control Gear Tail Light function	siehe Seite 9.10
50 125 000 24V	1	■	■			see page 9.10

LED Heckleuchte

LED Rear Combination Lamp

Typ: PRO-HORIZONTAL 12/24V IP6K9K
Funktion: LED Schlusslicht - LED Bremslicht - LED Blinklicht -
 opt. Rückfahrleuchte
 Anbaulage horizontal

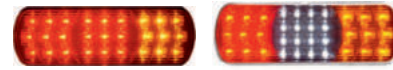
Function: LED Tail Lamp - LED Stop Lamp - LED Dir. Indicator Lamp -
 opt. Reversing Lamp
 Fixation horizontal

40 287 001

40 287 003

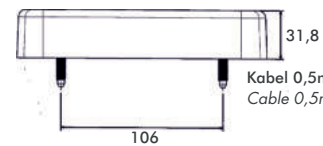
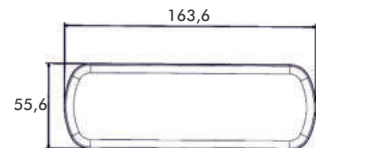

Artikel-Nr. Reference-No.	VE QTY	links left	rechts right	Rückfahr- leuchte Reversing lamp	Beschreibung - Hersteller Referenz Specification - O.E.-No.	Anschlußsystem - Zubehör - Ersatzteile Connector - Accessories - Spare Parts
40 287 001	1	■	■		Ausführung Kabel 0,5m version cable 0,5m	
40 287 003	1	■	■	■	Ausführung Kabel 0,5m version cable 0,5m	
50 140 012 12V	1	■	■		Zentral LED Kontrollgerät überwacht die Blinkleuchte und kontrolliert die Brems-Schluss- Nebelschluss-Rückfahrleuchte LED Control Gear monitors the direction indicator lamp and is checking the stop-tail-fog- reversing lamp	siehe Seite 9.1 PRO-LCG
50 140 024 24V	1					see page 9.1
50 141 012 12V	1				LED Kontrollgerät Blinklichtfunktion, Blinkerausfallkontrolle	siehe Seite 9.9 PRO-CONTROL
50 141 024 24V	1	■	■		LED Control Gear Direction Indicator function	see page 9.9
50 141 500 12/24V	1					
50 139 012 12V	1				LED Kontrollgerät kontrolliert die 21W Funktionen, Lastwiderstand	siehe Seite 9.10 PRO-LOAD
50 139 024 24V	1	■	■		LED Control Gear monitors the 21W functions	see page 9.10
50 125 012 12V	1				LED Kontrollgerät Schlusslichtfunktion Lastwiderstand	siehe Seite 9.10
50 125 000 24V	1	■	■		LED Control Gear Tail Light function	see page 9.10

LED Heckleuchte

LED Rear Combination Lamp

Typ: PRO-VERTICAL 12/24V IP6K9K

Funktion: LED Schlusslicht - LED Bremslicht - LED Blinklicht -
 opt. Rückfahrleuchte
 Anbaulage vertikal

Function: LED Tail Lamp - LED Stop Lamp - LED Dir. Indicator Lamp -
 opt. Reversing Lamp
 Fixation vertical

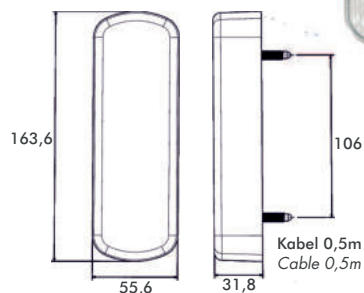
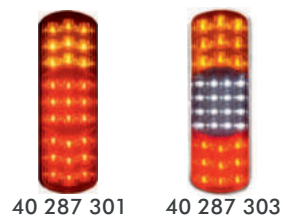

Artikel-Nr. Reference-No.	VE QTY	links left	rechts right	Rückfahr- leuchte Reversing lamp	Beschreibung - Hersteller Referenz Specification - O.E.-No.	Anschlußsystem - Zubehör - Ersatzteile Connector - Accessories - Spare Parts
40 287 301	1	■	■		Ausführung Kabel 0,5m version cable 0,5m	
40 287 303	1	■	■	■	Ausführung Kabel 0,5m version cable 0,5m	
50 140 012 12V	1	■	■		Zentral LED Kontrollgerät überwacht die Blinkleuchte und kontrolliert die Brems-Schluss- Nebelschluss-Rückfahrleuchte LED Control Gear monitors the direction indicator lamp and is checking the stop-tail-fog- reversing lamp	siehe Seite 9.1 PRO-LCG
50 140 024 24V	1					see page 9.1
50 141 012 12V	1				LED Kontrollgerät Blinklichtfunktion, Blinkerausfallkontrolle LED Control Gear Direction Indicator function	siehe Seite 9.9 PRO-CONTROL
50 141 024 24V	1	■	■			see page 9.9
50 141 500 12/24V	1					
50 139 012 12V	1	■	■		LED Kontrollgerät kontrolliert die 21W Funktionen, Lastwiderstand LED Control Gear monitors the 21W functions	siehe Seite 9.10 PRO-LOAD
50 139 024 24V	1					see page 9.10
50 125 012 12V	1	■	■		LED Kontrollgerät Schlusslichtfunktion Lastwiderstand LED Control Gear Tail Light function	siehe Seite 9.10
50 125 000 24V	1					see page 9.10

LED Heckleuchte

LED Rear Combination Lamp

Typ: PRO-SPOT ECO 12/24V IP6K9K

Funktion: LED Schlusslicht - LED Bremslicht - LED Blinklicht

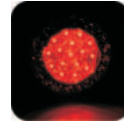

Function: LED Tail Lamp - LED Stop Lamp - LED Dir. Indicator Lamp

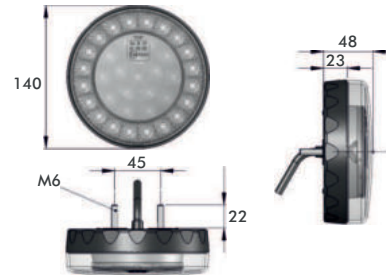

Artikel-Nr. Reference-No.	VE QTY	links left	rechts right	Kennz.- leuchte Numberplate- lamp	Beschreibung - Hersteller Referenz Specification - O.E.-No.	Anschlußsystem - Zubehör - Ersatzteile Connector - Accessories - Spare Parts
40 019 501	1	■	■		Ausführung Kabel 0,5m version cable 0,5m	
40 025 502	1	■	■		Komb. LED Nebelschluss-/ Rückfahrleuchte combined LED Fog-/ Reversing Lamp	siehe Seite 2.1
50 140 012 12V	1	■	■		Zentral LED Kontrollgerät überwacht die Blinkleuchte und kontrolliert die Brems-Schluss- Nebelschluss-Rückfahrleuchte LED Control Gear monitors the direction indicator lamp and is checking the stop-tail-fog- reversing lamp	siehe Seite 9.1 PRO-LCG
50 140 024 24V	1					see page 9.1
50 141 012 12V	1				LED Kontrollgerät Blinklichtfunktion, Blinkerausfallkontrolle	siehe Seite 9.9 PRO-CONTROL
50 141 024 24V	1	■	■		LED Control Gear Direction Indicator function	see page 9.9
50 141 500 12/24V	1					
50 139 012 12V	1				LED Kontrollgerät kontrolliert die 21W Funktionen, Lastwiderstand	siehe Seite 9.10 PRO-LOAD
50 139 024 24V	1	■	■		LED Control Gear monitors the 21W functions	see page 9.10
50 125 012 12V	1				LED Kontrollgerät Schlusslichtfunktion Lastwiderstand	siehe Seite 9.10
50 125 000 24V	1	■	■		LED Control Gear Tail Light function	see page 9.10

LED Heckleuchte

LED Rear Combination Lamp

Typ: PRO-SPOT ECO 12/24V IP6K9K

Funktion: LED Schlusslicht - LED Bremslicht - LED Blinklicht



Function: LED Tail Lamp - LED Stop Lamp - LED Dir. Indicator Lamp

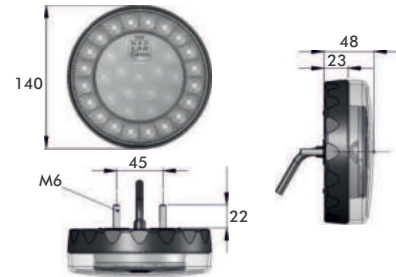

Artikel-Nr. Reference-No.	VE QTY	links left	rechts right	Kennz.- leuchte Numberplate- lamp	Beschreibung - Hersteller Referenz Specification - O.E.-No.	Anschlußsystem - Zubehör - Ersatzteile Connector - Accessories - Spare Parts
40 019 521	1	■	■		Ausführung Kabel 0,5m + 7-pol. AMP Stecker version cable 0,5m + 7-pol. AMP connector	
40 025 522	1	■	■		Komb. LED Nebelschluss-/ Rückfahrleuchte, Kabel 0,5m + 7-pol. AMP Stecker combined LED Fog-/ Reversing Lamp, cable 0,5m + 7-pol. AMP connector	siehe Seite 2.1
50 140 712 12V	1	■	■		Zentral LED Kontrollgerät überwacht die Blinkleuchte und kontrolliert die Brems-Schluss- Nebelschluss-Rückfahrleuchte LED Control Gear monitors the direction indicator lamp and is checking the stop-tail-fog- reversing lamp	siehe Seite 9.1 PRO-LCG
50 140 724 24V	1					see page 9.1

Anschlussmöglichkeit mit LED Kontrollgerät:
Fitting possibilities with LED Control Gear:
Plug 'n Play PRO-SPOT ECO & PRO-SPOT ECO FR

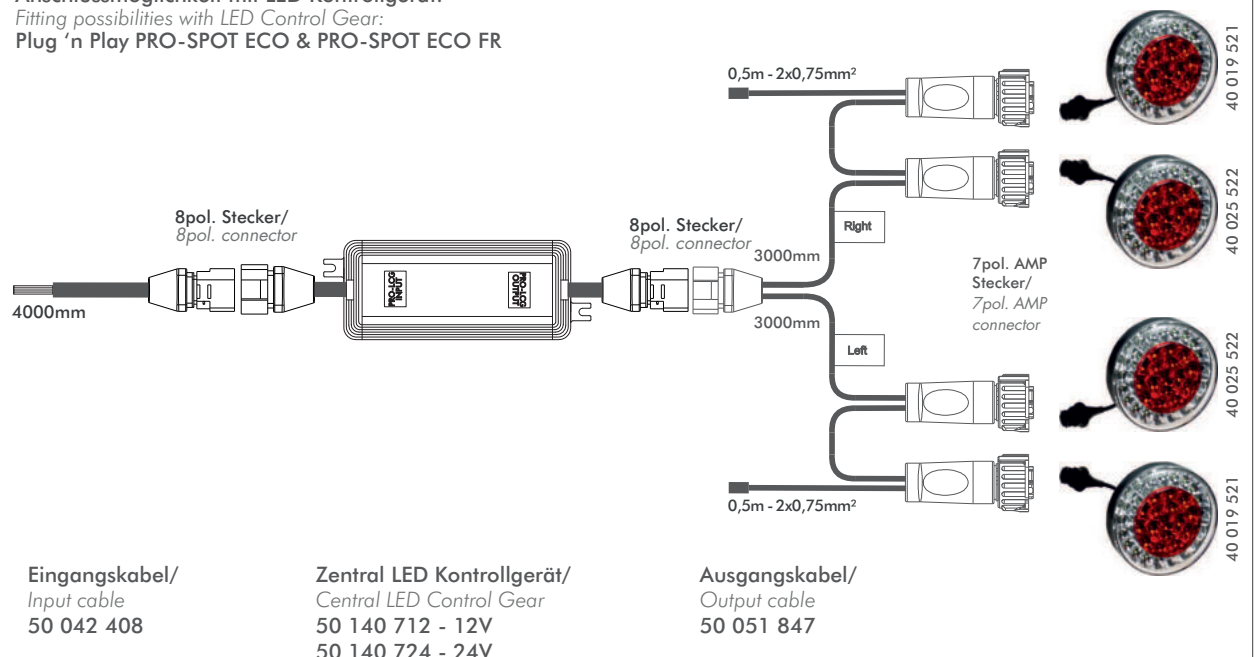

LED Heckleuchte

LED Rear Combination Lamp

Typ: PRO-SPOT 10V-30V IP6K9K

Funktion: LED Schlusslicht - LED Bremslicht - LED Blinklicht

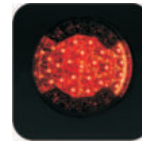

Function: LED Tail Lamp - LED Stop Lamp - LED Dir. Indicator Lamp

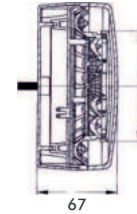

Artikel-Nr. Reference-No.	VE QTY	links left	rechts right	Kennz.- leuchte Numberplate- lamp	Beschreibung - Hersteller Referenz Specification - O.E.-No.	Anschlußsystem - Zubehör - Ersatzteile Connector - Accessories - Spare Parts
40 019 001	1	■	■		Ausführung PG-Verschraubung version PG-screw	
40 019 461	1	■	■		Ausführung Kabel 2,0m version cable 2,0m	
40 025 002	1	■	■		Nebelschluß-/Rückfahrleuchte Ausführung PG-Verschraubung Fog-/Reversing Lamp version PG-screw	siehe Seite 2.1
40 025 462	1	■	■		Nebelschluß-/Rückfahrleuchte Ausführung Kabel 2,0m Fog-/Reversing Lamp version cable 2,0m	siehe Seite 2.1
40 019 102	1	■	■		Einbau-Kit Chrom Built-In Kit chrome	
50 140 012 12V	1	■	■		Zentral LED Kontrollgerät überwacht die Blinkleuchte und kontrolliert die Brems-Schluss- Nebelschluss-Rückfahrleuchte LED Control Gear monitors the direction indicator lamp and is checking the stop-tail-fog- reversing lamp	siehe Seite 9.1 PRO-LCG
50 140 024 24V	1					see page 9.1

LED Heckleuchte

LED Rear Combination Lamp

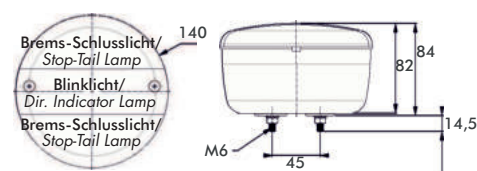
Typ: 3-Kammerleuchte 24V IP6K9KFunktion: 2 x LED Schlusslicht - 2 x LED Bremslicht -
dynamische LED BlinklichtfunktionFunction: 2 x LED Tail Lamp - 2 x LED Stop Lamp -
sequential LED Dir. Indicator LampBesonderheit: dynamische Blinklichtfunktion
Feature: sequential Direction Indicator Function

Artikel-Nr. Reference-No.	VE QTY	links left	rechts right	Kennz.- leuchte Numberplate- lamp	Beschreibung - Hersteller Referenz Specification - O.E.-No.	Anschlußsystem - Zubehör - Ersatzteile Connector - Accessories - Spare Parts
40 202 911	1	■			Ausführung Kabel 0,5m, links, dynamische Blinklichtfunktion version cable 0,5m, left, sequential direction indicator	
40 202 912	1		■		Ausführung Kabel 0,5m, rechts, dynamische Blinklichtfunktion version cable 0,5m, right, sequential direction indicator	
40 149 202	1	■	■		Komb. LED Nebelschluss-/ Rückfahrleuchte combined LED Fog-/ Reversing Lamp	siehe Seite 2.5
40 149 402	1	■	■		LED Nebelschlussleuchte LED Fog Lamp	siehe Seite 2.5
40 149 403	1	■	■		LED Rückfahrleuchte LED Reversing Lamp	siehe Seite 2.5
50 140 024 24V	1	■	■		Zentral LED Kontrollgerät überwacht die Blinkleuchte und kontrolliert die Brems-Schluss- Nebelschluss-Rückfahrleuchte LED Control Gear monitors the direction indicator lamp and is checking the stop-tail-fog- reversing lamp	siehe Seite 9.1 PRO-LCG
50 141 012 12V 50 141 024 24V 50 141 500 12/24V	1 1 1	■	■		LED Kontrollgerät Blinklichtfunktion, Blinkerausfallkontrolle LED Control Gear Direction Indicator function	siehe Seite 9.9 PRO-CONTROL



LED Heckleuchte

LED Rear Combination Lamp

Typ: 3-Kammerleuchte 12/24V IP6K9K

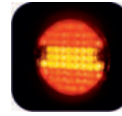

Funktion: 2 x LED Schlusslicht - 2 x LED Bremslicht - LED Blinklicht

Function: 2 x LED Tail Lamp - 2 x LED Stop Lamp - LED Dir. Indicator Lamp

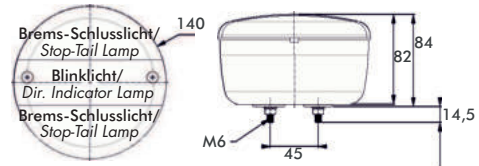

Artikel-Nr. Reference-No.	VE QTY	links left	rechts right	Kennz.- leuchte Numberplate-lamp	Beschreibung - Hersteller Referenz Specification - O.E.-No.	Anschlußsystem - Zubehör - Ersatzteile Connector - Accessories - Spare Parts
40 202 701	1	■	■		Ausführung Kabel 0,5m version cable 0,5m	
40 202 761	1	■	■		Ausführung Kabel 2,0m version cable 2,0m	
40 202 721	1	■	■		Ausführung 7-pol. AMP Stecker version 7-pol. AMP connector	
40 149 202	1	■	■		Komb. LED Nebelschluss-/ Rückfahrleuchte, Kabel 0,5m combined LED Fog-/ Reversing Lamp, cable 0,5m	siehe Seite 2.5
40 149 222	1	■	■		Komb. LED Nebelschluss-/ Rückfahrleuchte, 7-pol. AMP St. combined LED Fog-/ Reversing Lamp, 7-pol. AMP con.	siehe Seite 2.5

Anschlussmöglichkeit mit LED Kontrollgerät:
Fitting possibilities with LED Control Gear:
Plug 'n Play „Hamburger Style“

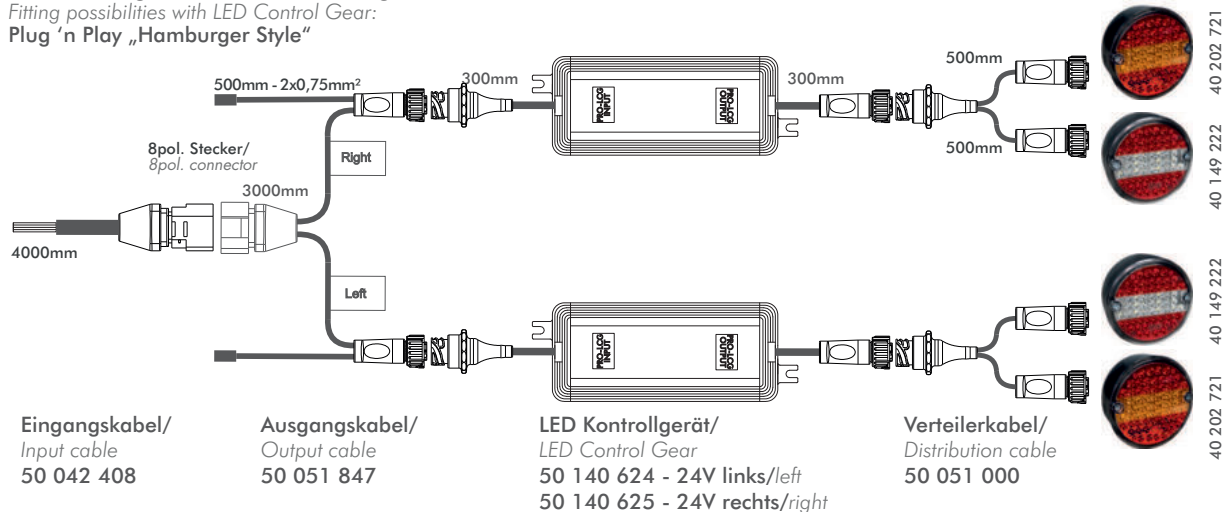



LED Heckleuchte

LED Rear Combination Lamp

Typ: 3-Kammerleuchte 24V IP6K9K



Funktion: LED Schlusslicht - LED Bremslicht - LED Blinklicht

D-Zulassung

Function: LED Tail Lamp - LED Stop Lamp - LED Dir. Indicator Lamp

D-Homologation

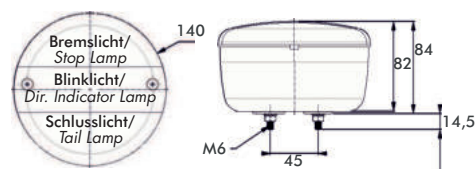

Besonderheit: D-Zulassung
Feature: D-approval

Artikel-Nr. Reference-No.	VE QTY	links left	rechts right	Kennz.- leuchte Numberplate- lamp	Beschreibung - Hersteller Referenz Specification - O.E.-No.	Anschlußsystem - Zubehör - Ersatzteile Connector - Accessories - Spare Parts
40 202 801	1	■	■		Ausführung Kabel 0,5m, D-Zulassung <i>version cable 0,5m, D-Homologation</i>	
40 202 821	1	■	■		Ausführung 7-pol. AMP Stecker, D-Zulassung <i>version 7-pol. AMP con., D-Homologation</i>	
40 149 202	1	■	■		Komb. LED Nebelschluss-/ Rückfahrleuchte, Kabel 0,5m <i>combined LED Fog-/ Reversing Lamp, cable 0,5m</i>	siehe Seite 2.5
40 149 222	1	■	■		Komb. LED Nebelschluss-/ Rückfahrleuchte, 7-pol. AMP St. <i>combined LED Fog-/ Reversing Lamp, 7-pol. AMP con.</i>	siehe Seite 2.5

Anschlussmöglichkeit mit LED Kontrollgerät:
Fitting possibilities with LED Control Gear:
Plug 'n Play „Hamburger Style“

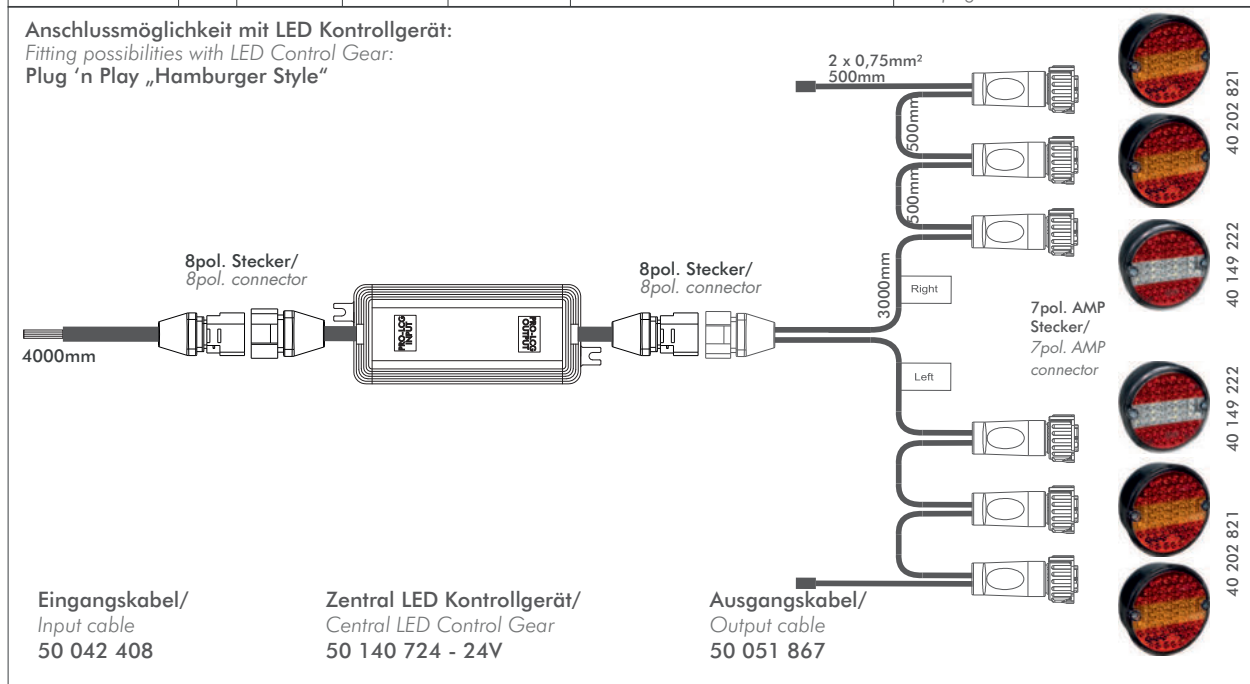

LED Heckleuchte

LED Rear Combination Lamp

Typ: 3-Kammerleuchte 12/24V

Funktion: 2 x LED Schlusslicht - 2 x LED Bremslicht -
LED Blinklicht

Function: 2 x LED Tail Lamp - 2 x LED Stop Lamp -
LED Dir. Indicator Lamp

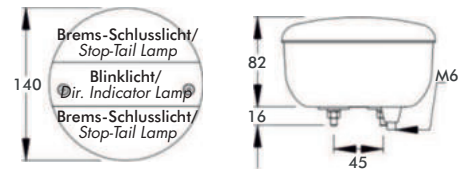

Artikel-Nr. Reference-No.	VE QTY	links left	rechts right	Kennz.- leuchte Numberplate- lamp	Beschreibung - Hersteller Referenz Specification - O.E.-No.	Anschlußsystem - Zubehör - Ersatzteile Connector - Accessories - Spare Parts
40 202 601	1	■	■		Ausführung Gummitülle version grommet	
40 149 402	1	■	■		LED Nebelschlussleuchte LED Fog Lamp	siehe Seite 2.5
40 149 403	1	■	■		LED Rückfahrleuchte LED Reversing Lamp	siehe Seite 2.5
50 140 012 12V	1	■	■		Zentral LED Kontrollgerät überwacht die Blinkleuchte und kontrolliert die Brems-Schluss- Nebelschluss-Rückfahrleuchte LED Control Gear monitors the direction indicator lamp and is checking the stop-tail-fog- reversing lamp	siehe Seite 9.1 PRO-LCG
50 140 024 24V	1					see page 9.1
50 141 012 12V	1				LED Kontrollgerät Blinklichtfunktion, Blinkerausfallkontrolle LED Control Gear Direction Indicator function	siehe Seite 9.9 PRO-CONTROL
50 141 024 24V	1	■	■			
50 141 500 12/24V	1					see page 9.9
50 139 012 12V	1	■	■		LED Kontrollgerät kontrolliert die 21W Funktionen, Lastwiderstand LED Control Gear monitors the 21W functions	siehe Seite 9.10 PRO-LOAD
50 139 024 24V	1					see page 9.10
50 125 012 12V	1	■	■		LED Kontrollgerät Schlusslichtfunktion Lastwiderstand LED Control Gear Tail Light function	siehe Seite 9.10 see page 9.10
50 125 000 24V	1					

LED Heckleuchte

LED Rear Combination Lamp

Typ: PRO-RING 12/24V

Funktion: LED Schlusslicht - LED Bremslicht - LED Blinklicht



Function: LED Tail Lamp - LED Stop Lamp - LED Dir. Indicator Lamp

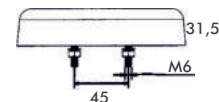
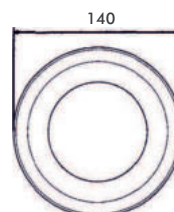

Artikel-Nr. Reference-No.	VE QTY	links left	rechts right	Kennz.- leuchte Numberplate- lamp	Beschreibung - Hersteller Referenz Specification - O.E.-No.	Anschlußsystem - Zubehör - Ersatzteile Connector - Accessories - Spare Parts
40 051 001	1	■	■		LED Schlusslicht in Lichtleitertechnik Ausführung Kabel 0,5m <i>LED Tail Lamp in Light guide technology version cable 0,5m</i>	
40 051 002	1	■	■		Komb. LED Nebelschluss-/ Rückfahrleuchte LED Schlusslicht in Lichtleitertechnik , Ausführung Kabel 0,5m <i>combined LED Fog-/Reversing Lamp, LED Tail Lamp in Light guide technology, version cable 0,5m</i>	siehe Seite 2.2
50 140 012 12V	1	■	■		Zentral LED Kontrollgerät überwacht die Blinkleuchte und kontrolliert die Brems-Schluss- Nebelschluss-Rückfahrleuchte <i>LED Control Gear monitors the direction indicator lamp and is checking the stop-tail-fog- reversing lamp</i>	siehe Seite 9.1 PRO-LCG
50 140 024 24V	1					siehe Seite 9.1
50 141 012 12V	1				LED Kontrollgerät Blinklichtfunktion, Blinkerausfallkontrolle <i>LED Control Gear Direction Indicator function</i>	siehe Seite 9.9 PRO-CONTROL
50 141 024 24V	1	■	■			
50 141 500 12/24V	1					siehe Seite 9.9
50 139 012 12V	1	■	■		LED Kontrollgerät kontrolliert die 21W Funktionen, Lastwiderstand <i>LED Control Gear monitors the 21W functions</i>	siehe Seite 9.10 PRO-LOAD
50 139 024 24V	1					siehe Seite 9.10
50 125 012 12V	1	■	■		LED Kontrollgerät Schlusslichtfunktion Lastwiderstand <i>LED Control Gear Tail Light function</i>	siehe Seite 9.10 see page 9.10
50 125 000 24V	1					

LED Heckleuchte

LED Rear Combination Lamp

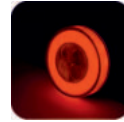
Typ: PRO-MINI-RING 12/24V IP6K9K

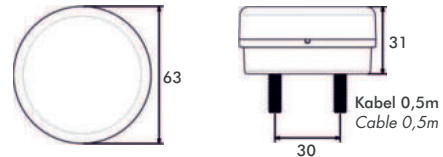
 Funktion: LED Schlusslicht - LED Bremslicht
 Aufbauversion

 Function: LED Tail Lamp - LED Stop Lamp
 Pendant version

Artikel-Nr. Reference-No.	VE QTY	links left	rechts right	Kennz.- leuchte Numberplate- lamp	Beschreibung - Hersteller Referenz Specification - O.E.-No.	Anschlußsystem - Zubehör - Ersatzteile Connector - Accessories - Spare Parts
40 054 032	1	■	■		LED Schlusslicht in Lichtleitertechnik Ausführung Kabel 0,5m LED Tail Lamp in Light guide technology version cable 0,5m	
40 054 001	1	■	■		LED Blinkleuchte LED Dir. Indicator Lamp	siehe Seite 2.11
40 054 022	1	■	■		LED Nebelschlussleuchte LED Fog Lamp	siehe Seite 2.5
40 054 003	1	■	■		LED Rückfahrleuchte LED Reversing Lamp	siehe Seite 2.5
50 140 012 12V	1	■	■		Zentral LED Kontrollgerät überwacht die Blinkleuchte und kontrolliert die Brems-Schluss- Nebelschluss-Rückfahrleuchte LED Control Gear monitors the direction indicator lamp and is checking the stop-tail-fog- reversing lamp	siehe Seite 9.1 PRO-LCG
50 140 024 24V	1					see page 9.1
50 141 012 12V	1				LED Kontrollgerät Blinklichtfunktion, Blinkerausfallkontrolle LED Control Gear Direction Indicator function	siehe Seite 9.9 PRO-CONTROL
50 141 024 24V	1	■	■			see page 9.9
50 141 500 12/24V	1					
50 139 012 12V	1	■	■		LED Kontrollgerät kontrolliert die 21W Funktionen, Lastwiderstand LED Control Gear monitors the 21W functions	siehe Seite 9.10 PRO-LOAD
50 139 024 24V	1					see page 9.10
50 125 012 12V	1	■	■		LED Kontrollgerät Schlusslichtfunktion Lastwiderstand LED Control Gear Tail Light function	siehe Seite 9.10
50 125 000 24V	1					see page 9.10

LED Heckleuchte

LED Rear Combination Lamp

Typ: PRO-MINI-RING 12/24V IP6K9K

 Funktion: LED Schlusslicht - LED Bremslicht
 Einbauversion

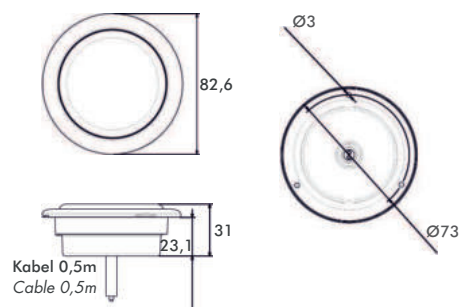
 Function: LED Tail Lamp - LED Stop Lamp
 Recessed version

Artikel-Nr. Reference-No.	VE QTY	links left	rechts right	Kennz.- leuchte Numberplate- lamp	Beschreibung - Hersteller Referenz Specification - O.E.-No.	Anschlußsystem - Zubehör - Ersatzteile Connector - Accessories - Spare Parts
40 054 532	1	■	■		LED Schlusslicht in Lichtleitertechnik , Ausführung Kabel 0,5m, Ring aus Edelstahl LED Tail Lamp in Light guide technology , version cable 0,5m, stainless steel ring	
40 054 501	1	■	■		LED Blinkleuchte LED Dir. Indicator Lamp	siehe Seite 2.11
40 054 522	1	■	■		LED Nebelschlussleuchte LED Fog Lamp	siehe Seite 2.5
40 054 503	1	■	■		LED Rückfahrleuchte LED Reversing Lamp	siehe Seite 2.5
50 140 012 12V	1	■	■		Zentral LED Kontrollgerät überwacht die Blinkleuchte und kontrolliert die Brems-Schluss- Nebelschluss-Rückfahrleuchte	siehe Seite 9.1 PRO-LCG
50 140 024 24V	1				LED Control Gear monitors the direction indicator lamp and is checking the stop-tail-fog- reversing lamp	siehe Seite 9.1
50 141 012 12V	1				LED Kontrollgerät Blinklichtfunktion, Blinkerausfallkontrolle	siehe Seite 9.9 PRO-CONTROL
50 141 024 24V	1	■	■		LED Control Gear Direction Indicator function	siehe Seite 9.9
50 141 500 12/24V	1					
50 139 012 12V	1	■	■		LED Kontrollgerät kontrolliert die 21W Funktionen, Lastwiderstand	siehe Seite 9.10 PRO-LOAD
50 139 024 24V	1				LED Control Gear monitors the 21W functions	siehe Seite 9.10
50 125 012 12V	1	■	■		LED Kontrollgerät Schlusslichtfunktion Lastwiderstand	siehe Seite 9.10
50 125 000 24V	1				LED Control Gear Tail Light function	siehe Seite 9.10

LED Heckleuchte

LED Rear Combination Lamp

Typ: PRO-OVAL 12/24V IP6K9K

Funktion: LED Schlusslicht - LED Bremslicht - LED Blinklicht



Function: LED Tail Lamp - LED Stop Lamp - LED Dir. Indicator Lamp

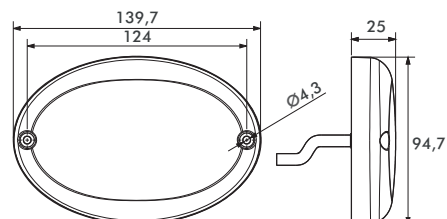

Artikel-Nr. Reference-No.	VE QTY	links left	rechts right	Kennz.- leuchte Numberplate- lamp	Beschreibung - Hersteller Referenz Specification - O.E.-No.	Anschlußsystem - Zubehör - Ersatzteile Connector - Accessories - Spare Parts
40 058 012	1	■	■		LED Schlusslicht in Lichtleitertechnik Ausführung Kabel 0,5m <i>LED Tail Lamp in Light guide technology version cable 0,5m</i>	
40 058 002	1	■	■		Komb. LED Nebelschluss-/ Rückfahrleuchte <i>combined LED Fog-/ Reversing Lamp</i>	siehe Seite 2.4 see page 2.4
40 058 911	1	■	■		Komb. LED Vordere Blink-/ Positionleuchte <i>combined LED Front Dir. Indicator-/Position Lamp</i>	siehe Seite 2.13 see page 2.13
50 140 012 12V	1	■	■		Zentral LED Kontrollgerät überwacht die Blinkleuchte und kontrolliert die Brems-Schluss- Nebelschluss-Rückfahrleuchte <i>LED Control Gear monitors the direction indicator lamp and is checking the stop-tail-fog- reversing lamp</i>	siehe Seite 9.1 see page 9.1 PRO-LCG
50 140 024 24V	1					
50 141 012 12V	1				LED Kontrollgerät Blinklichtfunktion, Blinkerausfallkontrolle <i>LED Control Gear Direction Indicator function</i>	siehe Seite 9.9 see page 9.9 PRO-CONTROL
50 141 024 24V	1	■	■			
50 141 500 12/24V	1					
50 139 012 12V	1	■	■		LED Kontrollgerät kontrolliert die 21W Funktionen, Lastwiderstand <i>LED Control Gear monitors the 21W functions</i>	siehe Seite 9.10 see page 9.10 PRO-LOAD
50 139 024 24V	1					
50 125 012 12V	1	■	■		LED Kontrollgerät Schlusslichtfunktion Lastwiderstand <i>LED Control Gear Tail Light function</i>	siehe Seite 9.10 see page 9.10
50 125 000 24V	1					

LED Heckleuchte

LED Rear Combination Lamp

Typ: PRO-TOP 12/24V IP6K9K

Funktion: LED Schlusslicht - LED Bremslicht - LED Blinklicht

Function: LED Tail Lamp - LED Stop Lamp - LED Dir. Indicator Lamp

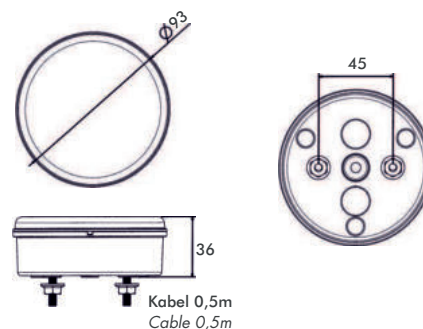

Artikel-Nr. Reference-No.	VE QTY	links left	rechts right	Kennz.- leuchte Numberplate- lamp	Beschreibung - Hersteller Referenz Specification - O.E.-No.	Anschlußsystem - Zubehör - Ersatzteile Connector - Accessories - Spare Parts
40 283 001	1	■	■		Ausführung Kabel 0,5m version cable 0,5m	
40 283 002	1	■	■		Komb. LED Nebelschluss-/ Rückfahrleuchte combined LED Fog-/ Reversing Lamp	siehe Seite 2.2
50 140 012 12V	1	■	■		Zentral LED Kontrollgerät überwacht die Blinkleuchte und kontrolliert die Brems-Schluss- Nebelschluss-Rückfahrleuchte LED Control Gear monitors the direction indicator lamp and is checking the stop-tail-fog- reversing lamp	siehe Seite 9.1 PRO-LCG
50 140 024 24V	1					see page 9.1
50 141 012 12V	1				LED Kontrollgerät Blinklichtfunktion, Blinkerausfallkontrolle LED Control Gear Direction Indicator function	siehe Seite 9.9 PRO-CONTROL
50 141 024 24V	1	■	■			see page 9.9
50 141 500 12/24V	1					
50 139 012 12V	1	■	■		LED Kontrollgerät kontrolliert die 21W Funktionen, Lastwiderstand LED Control Gear monitors the 21W functions	siehe Seite 9.10 PRO-LOAD
50 139 024 24V	1					see page 9.10
50 125 012 12V	1	■	■		LED Kontrollgerät Schlusslichtfunktion Lastwiderstand LED Control Gear Tail Light function	siehe Seite 9.10
50 125 000 24V	1					see page 9.10

LED Heckleuchte

LED Rear Combination Lamp

Typ: PRO-WAY 12/24V

Funktion: LED Schlusslicht - LED Bremslicht - LED Blinklicht



Function: LED Tail Lamp - LED Stop Lamp - LED Dir. Indicator Lamp

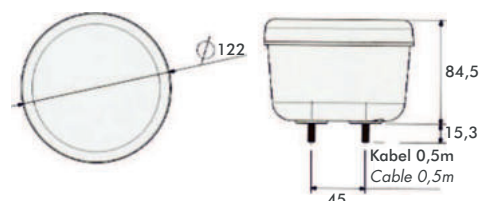

Artikel-Nr. Reference-No.	VE QTY	links left	rechts right	Kennz.- leuchte Numberplate- lamp	Beschreibung - Hersteller Referenz Specification - O.E.-No.	Anschlußsystem - Zubehör - Ersatzteile Connector - Accessories - Spare Parts
40 278 012	1	■	■		Ausführung Kabel 0,5m version cable 0,5m	
40 278 002	1	■	■		Komb. LED Nebelschluss-/ Rückfahrleuchte combined LED Fog-/ Reversing Lamp	siehe Seite 2.2 see page 2.2
50 140 012 12V	1	■	■		Zentral LED Kontrollgerät überwacht die Blinkleuchte und kontrolliert die Brems-Schluss- Nebelschluss-Rückfahrleuchte LED Control Gear monitors the direction indicator lamp and is checking the stop-tail-fog- reversing lamp	siehe Seite 9.1 PRO-LCG see page 9.1
50 140 024 24V	1					
50 141 012 12V	1				LED Kontrollgerät Blinklichtfunktion, Blinkerausfallkontrolle	siehe Seite 9.9 PRO-CONTROL see page 9.9
50 141 024 24V	1	■	■		LED Control Gear Direction Indicator function	
50 141 500 12/24V	1					
50 139 012 12V	1	■	■		LED Kontrollgerät kontrolliert die 21W Funktionen, Lastwiderstand	siehe Seite 9.10 PRO-LOAD see page 9.10
50 139 024 24V	1				LED Control Gear monitors the 21W functions	
50 125 012 12V	1	■	■		LED Kontrollgerät Schlusslichtfunktion Lastwiderstand	siehe Seite 9.10 see page 9.10
50 125 000 24V	1				LED Control Gear Tail Light function	



LED Heckleuchte

LED Rear Combination Lamp

Typ: PRO-MINI-CURVE 12/24V Hybrid



Funktion: LED Schlusslicht - LED Bremslicht - Blinklicht -
Rückfahrleuchte - Nebelschlussleuchte -
Dreieckrückstrahler
ohne Glühlampen

Function: LED Tail Lamp - LED Stop Lamp - Dir. Indicator Lamp -
Reversing Lamp - Fog Lamp - Triangle Reflex Reflector
without bulbs

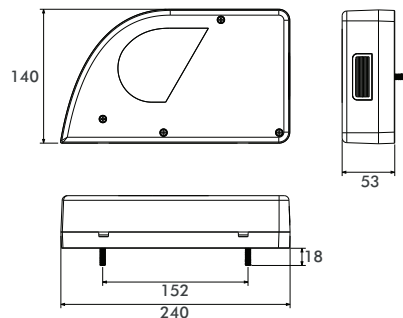

Artikel-Nr. Reference-No.	VE QTY	links left	rechts right	Kennz.- leuchte Numberplate- lamp	Beschreibung - Hersteller Referenz Specification - O.E.-No.	Anschlußsystem - Zubehör - Ersatzteile Connector - Accessories - Spare Parts
40 295 001	1	■		■ seitlich/ lateral	LED Schlusslicht in Lichtleitertechnik Ausführung Gummitülle LED Tail Lamp in Light guide technology version grommet	
40 295 002	1		■	■ seitlich/ lateral	LED Schlusslicht in Lichtleitertechnik Ausführung Gummitülle LED Tail Lamp in Light guide technology version grommet	
40 295 111	1	■			Lichtscheibe Lens	
40 295 112	1		■		Lichtscheibe Lens	
50 139 012 12V	1				LED Kontrollgerät kontrolliert die 21W Funktionen, Lastwiderstand	siehe Seite 9.10 PRO-LOAD
50 139 024 24V	1	■	■		LED Control Gear monitors the 21W functions	 see page 9.10
50 125 012 12V	1	■	■		LED Kontrollgerät Schlusslichtfunktion Lastwiderstand	siehe Seite 9.10
50 125 000 24V	1	■	■		LED Control Gear Tail Light function	 see page 9.10



LED Heckleuchte

LED Rear Combination Lamp



Typ: PRO-CURVE SQ 12/24V IP6K9K

Funktion: LED Schlusslicht - LED Bremslicht -
dynamische LED Blinkleuchte - LED Rückfahrleuchte -
LED Nebelschlussleuchte - Dreieckrückstrahler

Function: LED Tail Lamp - LED Stop Lamp -
sequential LED Dir. Indicator Lamp - LED Reversing Lamp -
LED Fog Lamp - Triangle Reflex Reflector

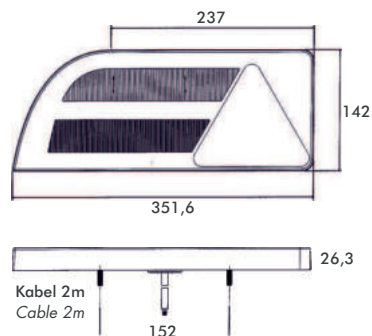

Besonderheit: dynamische Blinklichtfunktion
Feature: sequential Direction Indicator Function

Artikel-Nr. Reference-No.	VE QTY	links left	rechts right	Kennz.- leuchte Numberplate- lamp	Beschreibung - Hersteller Referenz Specification - O.E.-No.	Anschlußsystem - Zubehör - Ersatzteile Connector - Accessories - Spare Parts
40 292 511	1	■			Ausführung mit Kabel 2,0m <i>version with cable 2,0m</i>	
40 292 512	1		■		Ausführung mit Kabel 2,0m <i>version with cable 2,0m</i>	
50 140 012 12V	1	■	■		Zentral LED Kontrollgerät überwacht die Blinkleuchte und kontrolliert die Brems-Schluss- Nebelschluss-Rückfahrleuchte <i>LED Control Gear monitors the direction indicator lamp and is checking the stop-tail-fog- reversing lamp</i>	siehe Seite 9.1 PRO-LCG
50 140 024 24V	1					see page 9.1
50 141 012 12V	1				LED Kontrollgerät Blinklichtfunktion, Blinkerausfallkontrolle <i>LED Control Gear Direction Indicator function</i>	siehe Seite 9.9 PRO-CONTROL
50 141 024 24V	1	■	■			see page 9.9
50 141 500 12/24V	1					
50 139 012 12V	1	■	■		LED Kontrollgerät kontrolliert die 21W Funktionen, Lastwiderstand <i>LED Control Gear monitors the 21W functions</i>	siehe Seite 9.10 PRO-LOAD
50 139 024 24V	1					see page 9.10
50 125 012 12V	1	■	■		LED Kontrollgerät Schlusslichtfunktion Lastwiderstand <i>LED Control Gear Tail Light function</i>	siehe Seite 9.10
50 125 000 24V	1					see page 9.10



LED Heckleuchte

LED Rear Combination Lamp



Typ: PRO-CURVE SQ 12/24V IP6K9K

Funktion: LED Schlusslicht - LED Bremslicht -
dynamische LED Blinkleuchte - LED Rückfahrleuchte -
LED Nebelschlussleuchte - Dreieckrückstrahler

Function: LED Tail Lamp - LED Stop Lamp -
sequential LED Dir. Indicator Lamp - LED Reversing Lamp -
LED Fog Lamp - Triangle Reflex Reflector

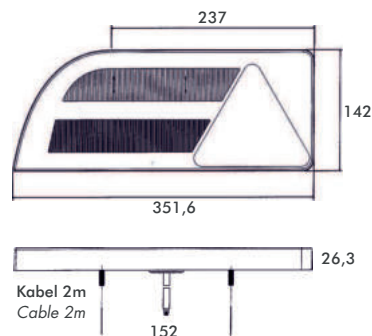

Besonderheit: dynamische Blinklichtfunktion
Feature: sequential Direction Indicator Function

Artikel-Nr. Reference-No.	VE QTY	links left	rechts right	Kennz.- leuchte Numberplate- lamp	Beschreibung - Hersteller Referenz Specification - O.E.-No.	Anschlußsystem - Zubehör - Ersatzteile Connector - Accessories - Spare Parts
40 292 611	1	■			Ausführung mit AMP Stecker 7-polig version with AMP connector 7-poles	
40 292 612	1		■		Ausführung mit AMP Stecker 7-polig version with AMP connector 7-poles	
50 140 624 24V	1	■			LED Kontrollgerät überwacht die Blinkleuchte und kontrolliert die Brems-Schluss-Nebelschluss- Rückfahrleuchte, 7pol. AMP St.	siehe Seite 9.0 PRO-LCG-ECO
50 140 625 24V	1		■		LED Control Gear monitors the direction indicator lamp and is checking the stop-tail-fog- reversing lamp, 7pol. AMP con.	see page 9.0
50 071 100	1	■	■		Reparaturset Repairkit	

Anschlussmöglichkeit mit LED Kontrollgerät:
Fitting possibilities with LED Control Gear:
Plug 'n Play PRO-CURVE SQ

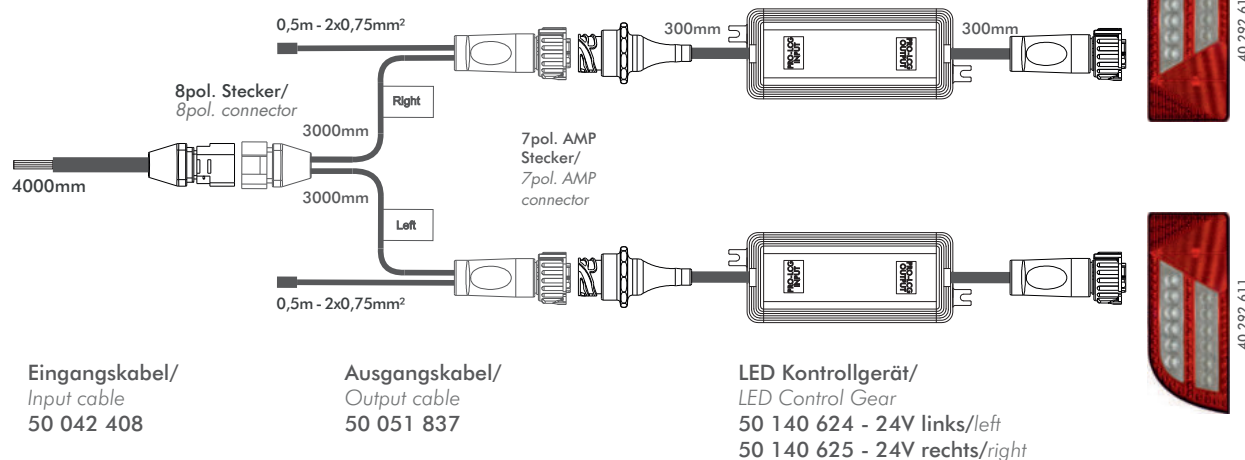



LED Heckleuchte

LED Rear Combination Lamp



Typ: PRO-CURVE SQ 12/24V IP6K9K

Funktion: LED Schlusslicht - LED Bremslicht -
dynamische LED Blinkleuchte - LED Rückfahrleuchte -
LED Nebelschlussleuchte - Dreieckrückstrahler

Function: LED Tail Lamp - LED Stop Lamp -
sequential LED Dir. Indicator Lamp - LED Reversing Lamp -
LED Fog Lamp - Triangle Reflex Reflector

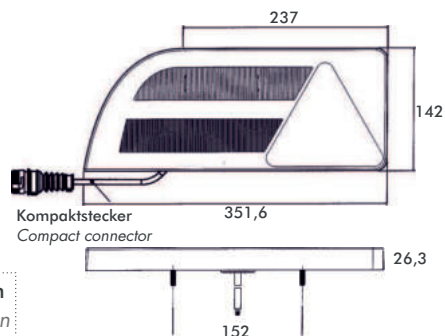

Besonderheit: dynamische Blinklichtfunktion
Feature: sequential Direction Indicator Function

Artikel-Nr. Reference-No.	VE QTY	links left	rechts right	Kennz.- leuchte Numberplate- lamp	Beschreibung - Hersteller Referenz Specification - O.E.-No.	Anschlußsystem - Zubehör - Ersatzteile Connector - Accessories - Spare Parts
40 292 711	1	■			Ausführung mit Kabel 0,5m + Kompaktstecker 7-polig version with cable 0,5m + connector 7-poles	
40 292 712	1		■		Ausführung mit Kabel 0,5m + Kompaktstecker 7-polig version with cable 0,5m + connector 7-poles	
40 246 603 24V	1	■	■		Kontrollgerät 24V Brems-Blink-Schlusslichtfunktion LED Control Gear 24V Stop-Tail-Dir.Indicator function	
50 140 012 12V	1	■	■		Zentral LED Kontrollgerät überwacht die Blinkleuchte und kontrolliert die Brems-Schluss- Nebelschluss-Rückfahrleuchte LED Control Gear monitors the direction indicator lamp and is checking the stop-tail-fog- reversing lamp	siehe Seite 9.1 PRO-LCG
50 140 024 24V	1					see page 9.1
50 141 012 12V	1				LED Kontrollgerät Blinklichtfunktion, Blinkerausfallkontrolle	siehe Seite 9.9 PRO-CONTROL
50 141 024 24V	1	■	■		LED Control Gear Direction Indicator function	
50 141 500 12/24V	1					see page 9.9
50 139 012 12V	1				LED Kontrollgerät kontrolliert die 21W Funktionen, Lastwiderstand	siehe Seite 9.10 PRO-LOAD
50 139 024 24V	1	■	■		LED Control Gear monitors the 21W functions	 see page 9.10
13 562 697	1	■	■		Kompaktstecker ASS2 für PRO-CURVE Schlussleuchte Connector ASS2 for PRO-CURVE Rear Combination Lamp	

LED Heckleuchte

LED Rear Combination Lamp



Typ: PRO-CURVE 12/24V IP6K9K

Funktion: LED Schlusslicht - LED Bremslicht - LED Blinklicht -
 LED Rückfahrleuchte - LED Nebelschlussleuchte -
 Dreieckrückstrahler

Function: LED Tail Lamp - LED Stop Lamp - LED Dir. Indicator Lamp -
 LED Reversing Lamp - LED Fog Lamp -
 Triangle Reflex Reflector

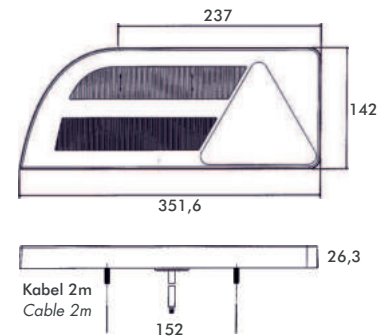

Artikel-Nr. Reference-No.	VE QTY	links left	rechts right	Kennz.- leuchte Numberplate- lamp	Beschreibung - Hersteller Referenz Specification - O.E.-No.	Anschlußsystem - Zubehör - Ersatzteile Connector - Accessories - Spare Parts
40 292 011	1	■			Ausführung mit Kabel 2,0m <i>version with cable 2,0m</i>	
40 292 012	1		■		Ausführung mit Kabel 2,0m <i>version with cable 2,0m</i>	
50 140 012 12V	1	■	■		Zentral LED Kontrollgerät überwacht die Blinkleuchte und kontrolliert die Brems-Schluss- Nebelschluss-Rückfahrleuchte <i>LED Control Gear monitors the direction indicator lamp and is checking the stop-tail-fog- reversing lamp</i>	siehe Seite 9.1 PRO-LCG
50 140 024 24V	1					see page 9.1
50 141 012 12V	1				LED Kontrollgerät Blinklichtfunktion, Blinkerausfallkontrolle <i>LED Control Gear Direction Indicator function</i>	siehe Seite 9.9 PRO-CONTROL
50 141 024 24V	1	■	■			see page 9.9
50 141 500 12/24V	1					
50 139 012 12V	1	■	■		LED Kontrollgerät kontrolliert die 21W Funktionen, Lastwiderstand <i>LED Control Gear monitors the 21W functions</i>	siehe Seite 9.10 PRO-LOAD
50 139 024 24V	1					see page 9.10
50 125 012 12V	1	■	■		LED Kontrollgerät Schlusslichtfunktion Lastwiderstand <i>LED Control Gear Tail Light function</i>	siehe Seite 9.10
50 125 000 24V	1					see page 9.10

LED Heckleuchte

LED Rear Combination Lamp



Typ: PRO-CURVE 12/24V IP6K9K

Funktion: LED Schlusslicht - LED Bremslicht - LED Blinklicht - LED Rückfahrleuchte - LED Nebelschlussleuchte - Dreieckrückstrahler

Function: LED Tail Lamp - LED Stop Lamp - LED Dir. Indicator Lamp - LED Reversing Lamp - LED Fog Lamp - Triangle Reflex Reflector

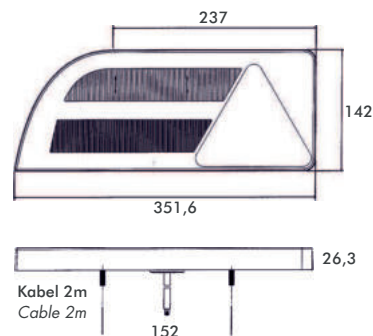

Artikel-Nr. Reference-No.	VE QTY	links left	rechts right	Kennz.- leuchte Numberplate- lamp	Beschreibung - Hersteller Referenz Specification - O.E.-No.	Anschlußsystem - Zubehör - Ersatzteile Connector - Accessories - Spare Parts
40 292 211	1	■			Ausführung mit AMP Stecker 7-polig version with AMP connector 7-poles	
40 292 212	1		■		Ausführung mit AMP Stecker 7-polig version with AMP connector 7-poles	
50 140 624 24V	1	■			LED Kontrollgerät überwacht die Blinkleuchte und kontrolliert die Brems-Schluss-Nebelschluss-Rückfahrleuchte, 7pol. AMP St. LED Control Gear monitors the direction indicator lamp and is checking the stop-tail-fog-reversing lamp, 7pol. AMP con.	siehe Seite 9.0 PRO-LCG-ECO
50 140 625 24V	1		■			see page 9.0
50 071 100	1	■	■		Reparaturset Repairkit	

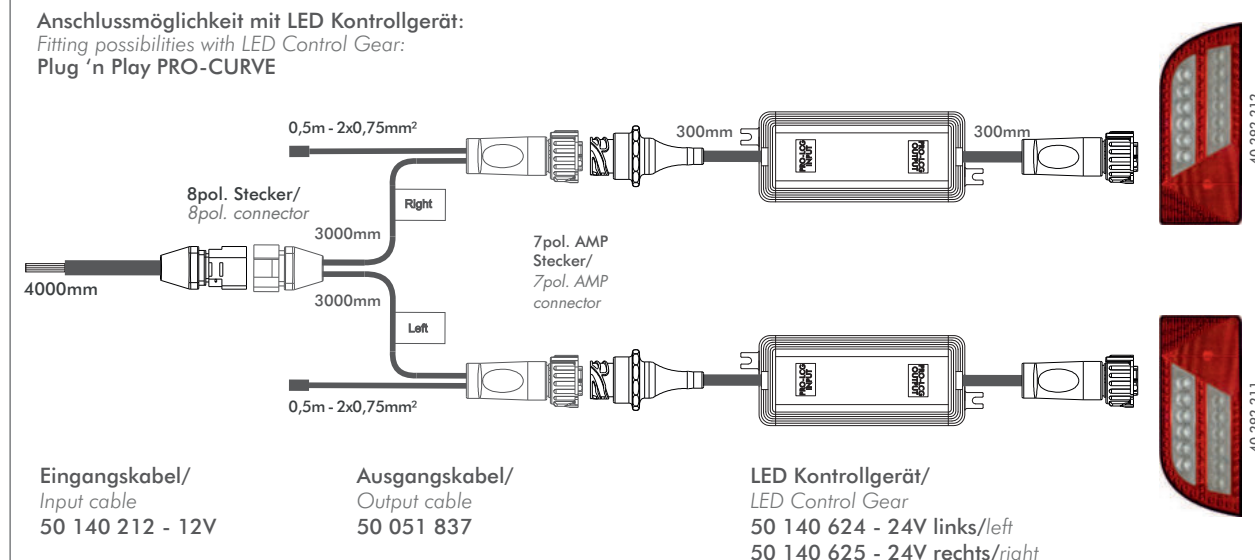

LED Heckleuchte

LED Rear Combination Lamp



Typ: PRO-CURVE 12/24V IP6K9K

Funktion: LED Schlusslicht - LED Bremslicht - LED Blinklicht -
 LED Rückfahrleuchte - LED Nebelschlussleuchte -
 Dreieckrückstrahler

Function: LED Tail Lamp - LED Stop Lamp - LED Dir. Indicator Lamp -
 LED Reversing Lamp - LED Fog Lamp -
 Triangle Reflex Reflector

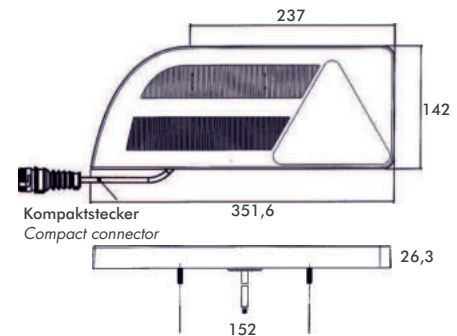

Artikel-Nr. Reference-No.	VE QTY	links left	rechts right	Kennz.- leuchte Numberplate- lamp	Beschreibung - Hersteller Referenz Specification - O.E.-No.	Anschlußsystem - Zubehör - Ersatzteile Connector - Accessories - Spare Parts
40 292 311	1	■			Ausführung mit Kabel 0,5m + Kompaktstecker 7-polig version with cable 0,5m + connector 7-poles	
40 292 312	1		■		Ausführung mit Kabel 0,5m + Kompaktstecker 7-polig version with cable 0,5m + connector 7-poles	
40 246 603 24V	1	■	■		Kontrollgerät 24V Brems-Blink-Schlusslichtfunktion LED Control Gear 24V Stop-Tail-Dir.Indicator function	
50 140 012 12V	1	■	■		Zentral LED Kontrollgerät überwacht die Blinkleuchte und kontrolliert die Brems-Schluss- Nebelschluss-Rückfahrleuchte LED Control Gear monitors the direction indicator lamp and is checking the stop-tail-fog- reversing lamp	siehe Seite 9.1 PRO-LCG
50 140 024 24V	1					see page 9.1
50 141 012 12V	1				LED Kontrollgerät Blinklichtfunktion, Blinkerausfallkontrolle	siehe Seite 9.9 PRO-CONTROL
50 141 024 24V	1	■	■		LED Control Gear Direction Indicator function	
50 141 500 12/24V	1					see page 9.9
50 139 012 12V	1				LED Kontrollgerät kontrolliert die 21W Funktionen, Lastwiderstand	siehe Seite 9.10 PRO-LOAD
50 139 024 24V	1	■	■		LED Control Gear monitors the 21W functions	
13 562 697	1	■	■		Kompaktstecker ASS2 für PRO-CURVE Schlussleuchte Connector ASS2 for PRO-CURVE Rear Combination Lamp	

LED Heckleuchte

LED Rear Combination Lamp

Typ: PRO-DISC 12/24V IP6K9K
Funktion: 2 x LED Schlusslicht - 2 x LED Bremslicht -
 LED Blinklicht - Dreieckrückstrahler

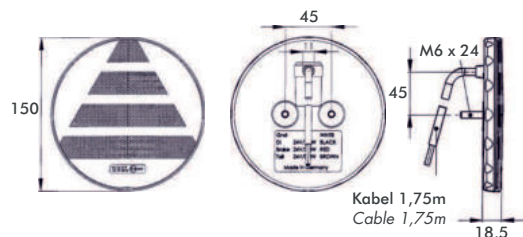
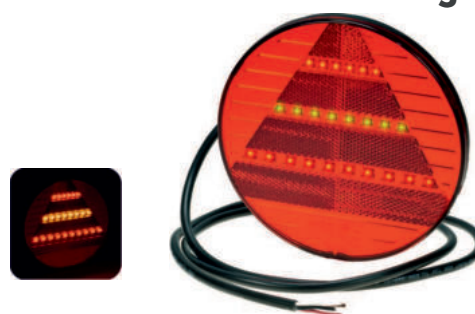
Function: 2 x LED Tail Lamp - 2 x LED Stop Lamp -
 LED Dir. Indicator Lamp - Triangle Reflex Reflector

Artikel-Nr. Reference-No.	VE QTY	links left	rechts right	Kennz.- leuchte Numberplate- lamp	Beschreibung - Hersteller Referenz Specification - O.E.-No.	Anschlußsystem - Zubehör - Ersatzteile Connector - Accessories - Spare Parts
40 050 001	1	■	■		Ausführung Kabel 1,8m version cable 1,8m	
40 050 212	1	■	■		Ausführung Kabel 0,2m + Anschlusstecker 5-polig Version with cable 0,2m + connector 5-poles	
40 050 501	1	■	■		Ausführung Kabel 1,8m ohne Dreieckrückstrahler version cable 1,8m without Triangle Reflex Reflector	
40 053 002	1	■	■		Komb. LED Nebelschluss-/ Rückfahrleuchte combined LED Fog-/ Reversing Lamp	siehe Seite 2.2 see page 2.2
50 140 012 12V	1	■	■		Zentral LED Kontrollgerät überwacht die Blinkleuchte und kontrolliert die Brems-Schluss- Nebelschluss-Rückfahrleuchte LED Control Gear monitors the direction indicator lamp and is checking the stop-tail-fog- reversing lamp	siehe Seite 9.1 PRO-LCG
50 140 024 24V	1					see page 9.1
50 141 012 12V	1				LED Kontrollgerät Blinklichtfunktion, Blinkerausfallkontrolle	siehe Seite 9.9 PRO-CONTROL
50 141 024 24V	1	■	■		LED Control Gear Direction Indicator function	see page 9.9
50 141 500 12/24V	1					
50 139 012 12V	1	■	■		LED Kontrollgerät kontrolliert die 21W Funktionen, Lastwiderstand	siehe Seite 9.10 PRO-LOAD
50 139 024 24V	1				LED Control Gear monitors the 21W functions	see page 9.10

LED Heckleuchte

LED Rear Combination Lamp

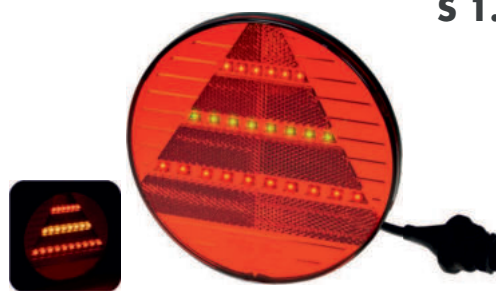

Typ: PRO-DISC 12/24V IP6K9K

Funktion: 2 x LED Schlusslicht - 2 x LED Bremslicht -
LED Blinklicht - Dreieckrückstrahler

Function: 2 x LED Tail Lamp - 2 x LED Stop Lamp -
LED Dir. Indicator Lamp - Triangle Reflex Reflector

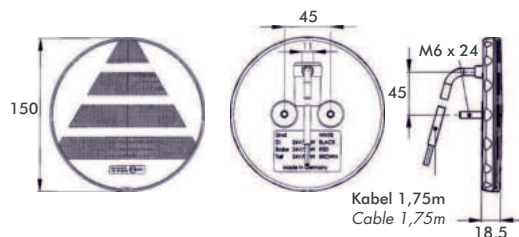

Artikel-Nr. Reference-No.	VE QTY	links left	rechts right	Kennz.- leuchte Numberplate- lamp	Beschreibung - Hersteller Referenz Specification - O.E.-No.	Anschlußsystem - Zubehör - Ersatzteile Connector - Accessories - Spare Parts
40 050 201	1	■	■		Ausführung Kabel 0,5m + 7-pol. AMP Stecker version cable 0,5m + 7-pol. AMP connector	
40 053 202	1	■	■		Komb. LED Nebelschluss-/ Rückfahrleuchte, Kabel 0,5m + 7-pol. AMP Stecker combined LED Fog-/ Reversing Lamp, cable 0,5m + 7-pol. AMP connector	siehe Seite 2.2 see page 2.2
50 140 712 12V	1	■	■		Zentral LED Kontrollgerät überwacht die Blinkleuchte und kontrolliert die Brems-Schluss- Nebelschluss-Rückfahrleuchte LED Control Gear monitors the direction indicator lamp and is checking the stop-tail-fog- reversing lamp	siehe Seite 9.1 PRO-LCG
50 140 724 24V	1					see page 9.1

Anschlussmöglichkeit mit LED Kontrollgerät:
Fitting possibilities with LED Control Gear:
Plug 'n Play PRO-DISC & PRO-DISC FR

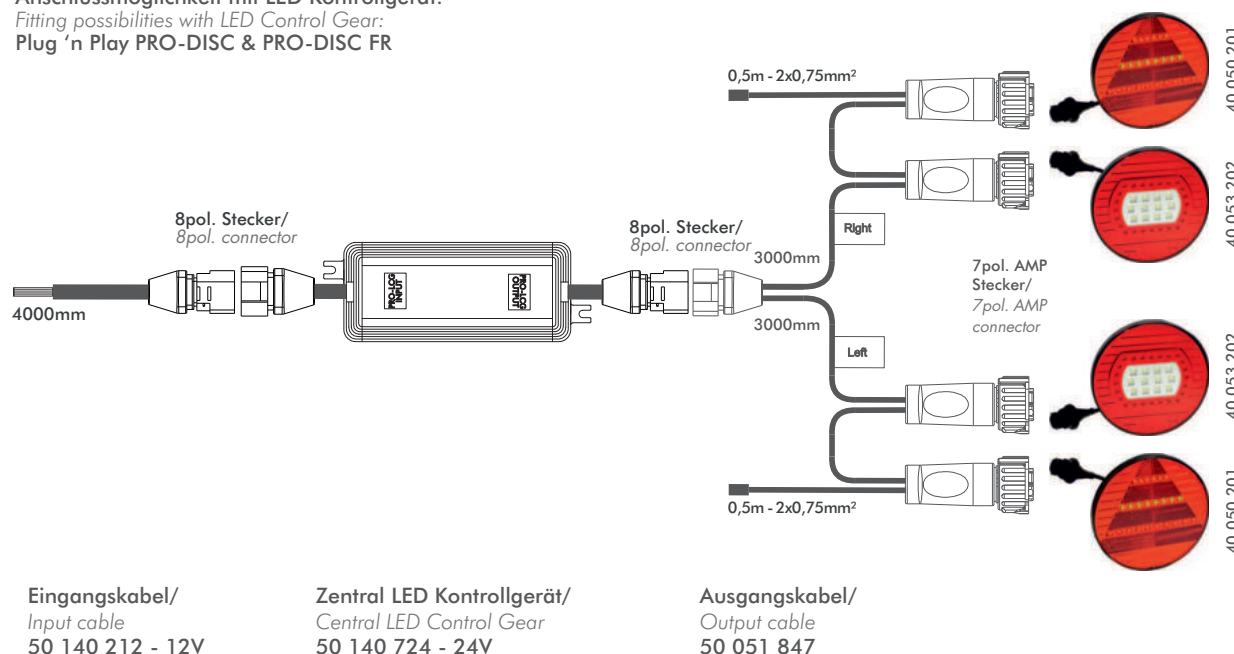

LED Heckleuchte

LED Rear Combination Lamp

Typ: PRO-5/5F 24V IP67

Funktion: 2 x LED Schlusslicht - LED Bremslicht -
 dynamische LED Blinkleuchte - LED Rückfahrleuchte -
 LED Nebelschlussleuchte - Dreieckrückstrahler
 LED Leuchtenmodule + Rückstrahler auswechselbar

Function: 2x LED Tail Lamp - LED Stop Lamp -
 sequential LED Dir. Indicator Lamp - LED Reversing Lamp -
 LED Fog Lamp - Triangle Reflex Reflector
 LED Lamp modules + reflex reflector replaceable



Besonderheit: dynamische Blinklichtfunktion
 Feature: sequential Direction Indicator Function

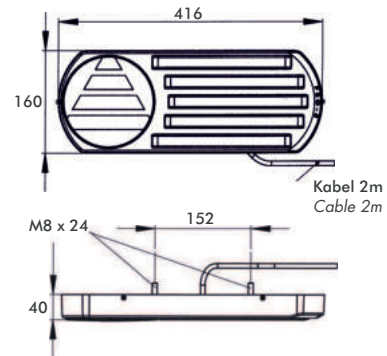

Artikel-Nr. Reference-No.	VE QTY	links left	rechts right	Kennz.- leuchte Numberplate- lamp	Beschreibung - Hersteller Referenz Specification - O.E.-No.	Anschlußsystem - Zubehör - Ersatzteile Connector - Accessories - Spare Parts
40 280 011	1	■			Ausführung mit Kabel 2,0m version with cable 2,0m	
40 280 012	1		■		Ausführung mit Kabel 2,0m version with cable 2,0m	
50 140 024 24V	1	■	■		Zentral LED Kontrollgerät überwacht die Blinkleuchte und kontrolliert die Brems-Schluss- Nebelschluss-Rückfahrleuchte LED Control Gear monitors the direction indicator lamp and is checking the stop-tail-fog- reversing lamp	siehe Seite 9.0 PRO-LCG see page 9.0
40 026 032 24V	1	■	■		LED Einsatz Brems-Schlussleuchte LED Unit Stop-Tail Lamp	PRO-CAN XL
40 026 051 24V	1	■	■		LED Einsatz dynamische Blinkleuchte LED Unit sequential Dir. Indicator Lamp	PRO-CAN XL
40 026 002 24V	1	■	■		LED Einsatz Schlussleuchte LED Unit Tail Lamp	PRO-CAN XL
40 026 503 24V	1	■	■		LED Einsatz Rückfahrleuchte LED Unit Reversing Lamp	PRO-CAN XL
40 026 022 24V	1	■	■		LED Einsatz Nebelschlussleuchte LED Unit Fog Lamp	PRO-CAN XL
20 105 004	1	■	■		Rückstrahler in brillianter Spiegeloptik Reflex Reflector in brilliant clear glass optic	PRO-REFLEX
40 280 112	1	■	■		Gehäuseabdeckung anthrazit Cover for housing in anthracite	

LED Heckleuchte



LED Rear Combination Lamp

Typ: PRO-5/5F 24V IP67

Funktion: 2 x LED Schlusslicht - LED Bremslicht - LED Blinklicht - LED Rückfahrleuchte - LED Nebelschlussleuchte - Dreieckrückstrahler
LED Leuchtenmodule + Rückstrahler auswechselbar

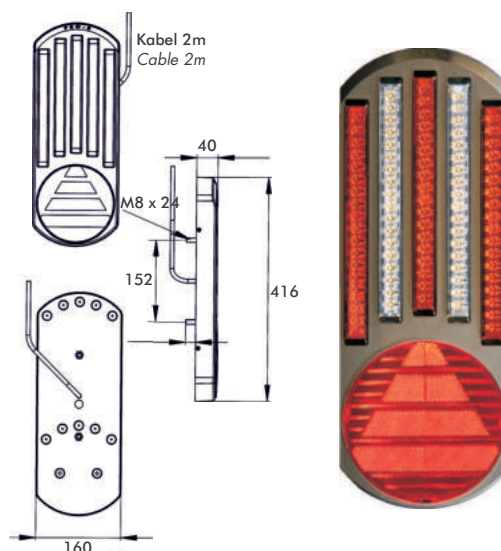
Function: 2x LED Tail Lamp - LED Stop Lamp - LED Dir. Indicator Lamp - LED Reversing Lamp - LED Fog Lamp - Triangle Reflex Reflector
LED Lamp modules + reflex reflector replaceable



Artikel-Nr. Reference-No.	VE QTY	links left	rechts right	Kennz.- leuchte Numberplate- lamp	Beschreibung - Hersteller Referenz Specification - O.E.-No.	Anschlußsystem - Zubehör - Ersatzteile Connector - Accessories - Spare Parts
40 280 013	1	■			Ausführung mit Kabel 2,0m version with cable 2,0m	Ausführung vertikal version vertical
40 280 014	1		■		Ausführung mit Kabel 2,0m version with cable 2,0m	Ausführung vertikal version vertical
50 140 024 24V	1	■	■		Zentral LED Kontrollgerät überwacht die Blinkleuchte und kontrolliert die Brems-Schluss- Nebelschluss-Rückfahrleuchte LED Control Gear monitors the direction indicator lamp and is checking the stop-tail-fog- reversing lamp	siehe Seite 9.0 PRO-LCG  see page 9.0
40 026 032 24V	1	■	■		LED Einsatz Brems-Schlussleuchte LED Unit Stop-Tail Lamp	PRO-CAN XL 
40 026 601 24V	1	■	■		LED Einsatz Blinkleuchte LED Unit Dir. Indicator Lamp	PRO-CAN XL 
40 026 002 24V	1	■	■		LED Einsatz Schlussleuchte LED Unit Tail Lamp	PRO-CAN XL 
40 026 503 24V	1	■	■		LED Einsatz Rückfahrleuchte LED Unit Reversing Lamp	PRO-CAN XL 
40 026 022 24V	1	■	■		LED Einsatz Nebelschlussleuchte LED Unit Fog Lamp	PRO-CAN XL 
40 280 112	1	■	■		Gehäuseabdeckung anthrazit Cover for housing in anthracite	

LED Heckleuchte

LED Rear Combination Lamp

Typ: PRO-LANE 12/24V IP6K9K

Funktion: LED Schlusslicht - LED Bremslicht - LED Blinklicht -
LED Rückfahrleuchte - LED Nebelschlussleuchte -
Dreieckrückstrahler

Function: LED Tail Lamp - LED Stop Lamp - LED Dir. Indicator Lamp -
LED Reversing Lamp - LED Fog Lamp -
Triangle Reflex Reflector

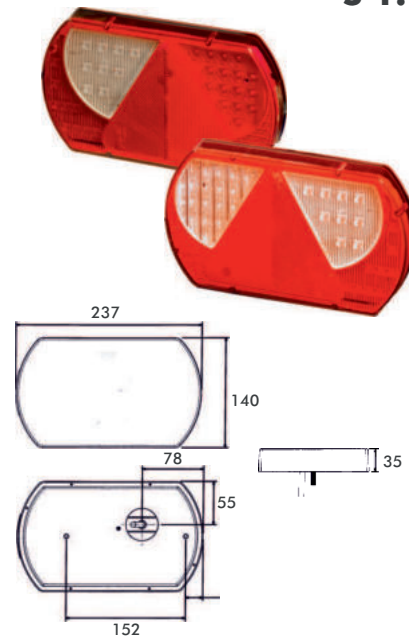

Artikel-Nr. Reference-No.	VE QTY	links left	rechts right	Kennz.- leuchte Numberplate- lamp	Beschreibung - Hersteller Referenz Specification - O.E.-No.	Anschlußsystem - Zubehör - Ersatzteile Connector - Accessories - Spare Parts
40 291 011	1	■		■ seitlich/ lateral	Ausführung Kabel 2,0m mit Nebelschlussleuchte <i>version cable 2,0m with Fog Lamp</i>	
40 291 013	1		■	■ seitlich/ lateral	Ausführung Kabel 2,0m mit Rückfahrleuchte <i>version cable 2,0m with Reversing Lamp</i>	
40 291 311	1	■			Ausführung Kabel 2,0m mit Nebelschlussleuchte <i>version cable 2,0m with Fog Lamp</i>	
40 291 313	1		■		Ausführung Kabel 2,0m mit Rückfahrleuchte <i>version cable 2,0m with Reversing Lamp</i>	
50 140 012 12V	1	■	■		Zentral LED Kontrollgerät überwacht die Blinkleuchte und kontrolliert die Brems-Schluss- Nebelschluss-Rückfahrleuchte <i>LED Control Gear monitors the direction indicator lamp and is checking the stop-tail-fog- reversing lamp</i>	siehe Seite 9.1 PRO-LCG 
50 140 024 24V	1					see page 9.1
50 141 012 12V	1				LED Kontrollgerät Blinklichtfunktion, Blinkerausfallkontrolle	siehe Seite 9.9 PRO-CONTROL 
50 141 024 24V	1	■	■		<i>LED Control Gear Direction Indicator function</i>	see page 9.9
50 141 500 12/24V	1					
50 139 012 12V	1	■	■		LED Kontrollgerät kontrolliert die 21W Funktionen, Lastwiderstand	siehe Seite 9.10 PRO-LOAD 
50 139 024 24V	1				<i>LED Control Gear monitors the 21W functions</i>	see page 9.10
50 125 012 12V	1	■	■		LED Kontrollgerät Schlusslichtfunktion Lastwiderstand	siehe Seite 9.10 
50 125 000 24V	1				<i>LED Control Gear Tail Light function</i>	see page 9.10

LED Heckleuchte

LED Rear Combination Lamp

Typ: PRO-LANE II 12V

Funktion: LED Schlusslicht - LED Bremslicht - LED Blinklicht - LED Rückfahrleuchte - LED Nebelschlussleuchte - Dreieckrückstrahler

Function: LED Tail Lamp - LED Stop Lamp - LED Dir. Indicator Lamp - LED Reversing Lamp - LED Fog Lamp - Triangle Reflex Reflector

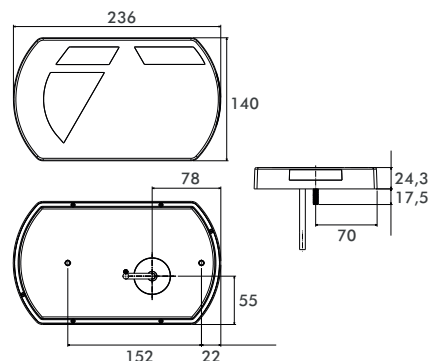

Artikel-Nr. Reference-No.	VE QTY	links left	rechts right	Kennz.- leuchte Numberplate- lamp	Beschreibung - Hersteller Referenz Specification - O.E.-No.	Anschlußsystem - Zubehör - Ersatzteile Connector - Accessories - Spare Parts
40 297 211	1	■		■ seitlich/ lateral	Ausführung Stecker 5-polig mit Nebelschlussleuchte <i>version connector 5-poles with Fog Lamp</i>	
40 297 213	1		■	■ seitlich/ lateral	Ausführung Stecker 5-polig mit Rückfahrleuchte <i>version connector 5-poles with Reversing Lamp</i>	
50 047 000	1	■	■		Reparaturset 5-polig, Buchsengehäuse <i>Repairkit 5-poles, female</i>	
50 140 512 12V	1	■			LED Kontrollgerät überwacht die Blinkleuchte und kontrolliert die Brems-Schluss-Nebelschluss- Rückfahrleuchte, 5pol. Bajonett <i>LED Control Gear monitors the direction indicator lamp and is checking the stop-tail-fog- reversing lamp, 5pol. bayonet</i>	siehe Seite 9.0 PRO-LCG-ECO
50 140 513 12V	1		■			see page 9.0

Anschlussmöglichkeit mit LED Kontrollgerät:
Fitting possibilities with LED Control Gear:
Plug 'n Play PRO-LANE II

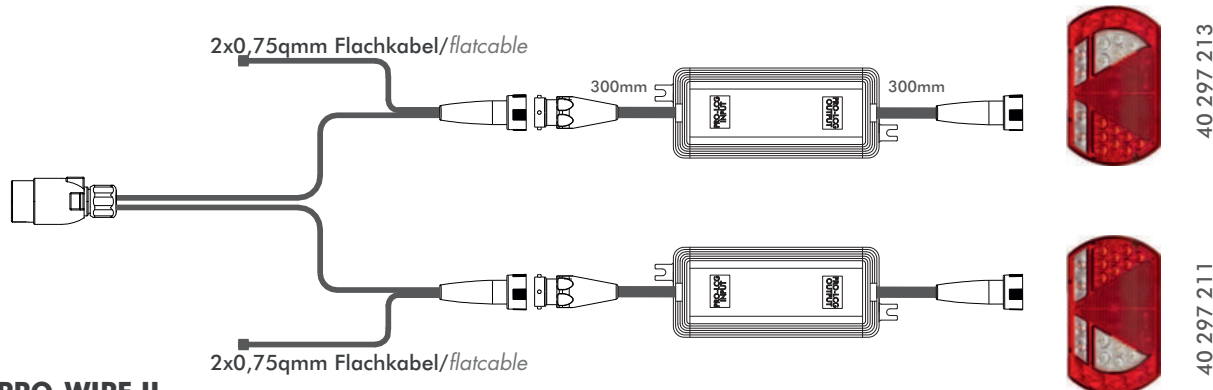

PRO-WIRE II

58 109 820

Länge 7,0m mit 2 Flachleitungen 0,5m/
Length 7,0m with 2 flatcable 0,5m

LED Kontrollgerät/
LED Control Gear

50 140 512 - 12V links/left

50 140 513 - 12V rechts/right

LED Heckleuchte

LED Rear Combination Lamp

Typ: PRO-EDGE 12/24V

Funktion: LED Schlusslicht - LED Bremslicht - LED Blinklicht - LED Rückfahrleuchte - LED Nebelschlussleuchte - Dreieckrückstrahler

Function: LED Tail Lamp - LED Stop Lamp - LED Dir. Indicator Lamp - LED Reversing Lamp - LED Fog Lamp - Triangle Reflex Reflector

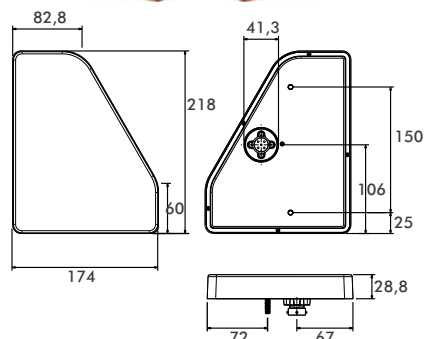

Artikel-Nr. Reference-No.	VE QTY	links left	rechts right	Kennz.- leuchte Numberplate- lamp	Beschreibung - Hersteller Referenz Specification - O.E.-No.	Anschlußsystem - Zubehör - Ersatzteile Connector - Accessories - Spare Parts
40 238 211	1	■			Ausführung Stecker 5-polig mit Nebelschlussleuchte <i>version connector 5-poles with Fog Lamp</i>	
40 238 212	1		■		Ausführung Stecker 5-polig mit Rückfahrleuchte <i>version connector 5-poles with Reversing Lamp</i>	
50 047 000	1	■	■		Reparaturset 5-polig, Buchsengehäuse <i>Repairkit 5-poles, female</i>	
50 140 512 <i>links/left</i>	1	■			LED Kontrollgerät überwacht die Blinkleuchte und kontrolliert die Brems-Schluss-Nebelschluss-Rückfahrleuchte, 5pol. Bajonett <i>LED Control Gear monitors the direction indicator lamp and is checking the stop-tail-fog-reversing lamp, 5pol. bayonet</i>	siehe Seite 9.0
50 140 513 <i>rechts/right</i>	1		■			PRO-LCG-ECO see page 9.0

Anschlussmöglichkeit mit LED Kontrollgerät:
Fitting possibilities with LED Control Gear:
Plug 'n Play PRO-EDGE

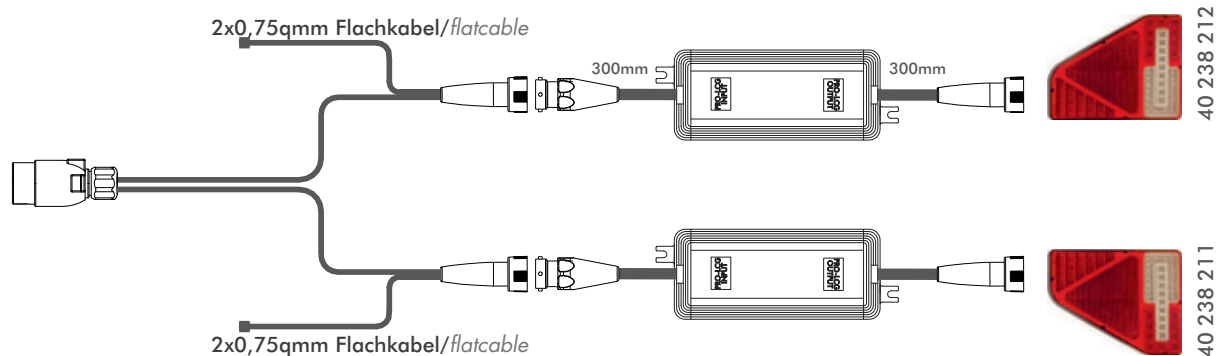

PRO-WIRE II

58 109 820

Länge 7,0m mit 2 Flachleitungen 0,5m/
Length 7,0m with 2 flatcable 0,5m

LED Kontrollgerät/
LED Control Gear

50 140 512 - 12V links/left

50 140 513 - 12V rechts/right

LED Heckleuchte

LED Rear Combination Lamp

Typ: ECOLED 24V IP69K

Funktion: LED Schlusslicht - LED Bremslicht - LED Blinklicht -
 LED Rückfahrleuchte - LED Nebelschlussleuchte -
 LED Seitenmarkierungsleuchte - Dreieckrückstrahler

Function: LED Tail Lamp - LED Stop Lamp - LED Dir. Indicator Lamp -
 LED Reversing Lamp - LED Fog Lamp -
 LED Side Marker Lamp - Triangle Reflex Reflector

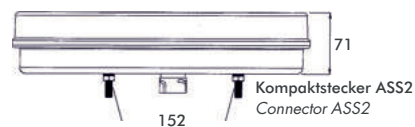
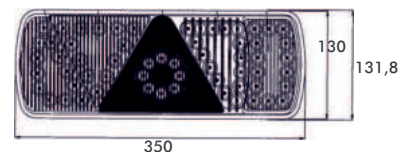

Artikel-Nr. Reference-No.	VE QTY	links left	rechts right	Kennz.- leuchte Numberplate- lamp	Beschreibung - Hersteller Referenz Specification - O.E.-No.	Anschlußsystem - Zubehör - Ersatzteile Connector - Accessories - Spare Parts
40 290 211	1	■			Aspöck 25-3800-507 Ausführung mit Aspöck ASS2 Stecker version with Aspöck ASS2 connector	
40 290 212	1		■		Aspöck 25-3900-507 Ausführung mit Aspöck ASS2 Stecker version with Aspöck ASS2 connector	
40 246 603	1	■	■		Aspöck 75-0300-001 LED Kontrollgerät, Aspöck ASS2 Brems-Blink-Schlusslichtfkt. LED Control Gear, Aspöck ASS2 for Stop-Tail-Dir.Indicator function	
50 047 001	1	■			Aspöck 13-5626-941 Anschlußstecker gelb, passend für Aspöck ASS1 & ASS2 Stecker Connector yellow, for Aspöck ASS1 & ASS2 connector system	
50 047 002	1		■		Aspöck 13-5626-951 Anschlußstecker grün, passend für Aspöck ASS1 & ASS2 Stecker Connector green, for Aspöck ASS1 & ASS2 connector system	

LED Heckleuchte

LED Rear Combination Lamp

Typ: ECOLED 24V IP69K

Funktion: LED Schlusslicht - LED Bremslicht - LED Blinklicht -
 LED Rückfahrleuchte - LED Nebelschlussleuchte -
 LED Umrißleuchte - Dreieckrückstrahler

Function: LED Tail Lamp - LED Stop Lamp - LED Dir. Indicator Lamp -
 LED Reversing Lamp - LED Fog Lamp -
 LED End Outline Marker Lamp - Triangle Reflex Reflector

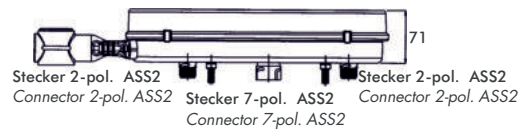
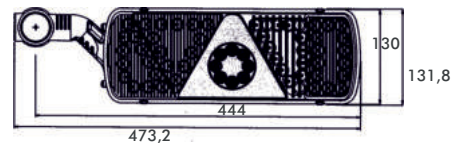

Artikel-Nr. Reference-No.	VE QTY	links left	rechts right	Kennz.- leuchte Numberplate- lamp	Beschreibung - Hersteller Referenz Specification - O.E.-No.	Anschlußsystem - Zubehör - Ersatzteile Connector - Accessories - Spare Parts
40 290 311	1	■			Aspöck 25-3820-517 Aspöck Steckersystem ASS2, 1 x 7-polig, 2 x 2-polig Aspöck connector system ASS2, 1 x 7-poles, 2 x 2-poles	
40 290 312	1		■		Aspöck 25-3920-517 Aspöck Steckersystem ASS2, 1 x 7-polig, 2 x 2-polig Aspöck connector system ASS2, 1 x 7-poles, 2 x 2-poles	
40 246 603	1	■	■		Aspöck 75-0300-001 LED Kontrollgerät, Aspöck ASS2 Brems-Blink-Schlusslichtfkt. LED Control Gear, Aspöck ASS2 for Stop-Tail-Dir.Indicator function	
50 047 001	1	■			Aspöck 13-5626-941 Anschlußstecker gelb, passend für Aspöck ASS1 & ASS2 Stecker Connector yellow, for Aspöck ASS1 & ASS2 connector system	
50 047 002	1		■		Aspöck 13-5626-951 Anschlußstecker grün, passend für Aspöck ASS1 & ASS2 Stecker Connector green, for Aspöck ASS1 & ASS2 connector system	

Heckleuchte

Rear Combination Lamp

Typ: LC8 M.A.N.

Funktion: Blink-, Stop-, Rück-, Nebelschluß-, Rückfahr-, Umriß-,
 Kennzeichen-, Seitenmarkierungsleuchte rot,
 Rückstrahler, Opt. Rückfahrwarner

Function: Dir.Indicator, Stop-, Rear-, Fog-, Reverse-, End Outline
 Marker-, Numberplate-, Sidemarker Lamp red,
 Reflex Reflector, Opt. Back Alarm System

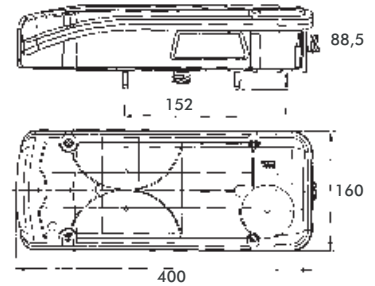

Artikel-Nr. Reference-No.	VE QTY	links left	rechts right	Kennz.- leuchte Numberplate- lamp	Beschreibung - Hersteller Referenz Specification - O.E.-No.	Anschlußsystem - Zubehör - Ersatzteile Connector - Accessories - Spare Parts
40 253 012	1		■		M.A.N. TG-A 81.25225.6545	
40 253 013	1	■		■	M.A.N. TG-A 81.25225.6544	
40 253 015	1		■		M.A.N. TG-A 81.25225.6547 Integrierter Rückfahrwarner Back Alarm System	
40 253 111	1	■			M.A.N. TG-A 81.25229.6059 Lichtscheibe Lens	
40 253 112	1		■		M.A.N. TG-A 81.25229.6060 Lichtscheibe Lens	
50 071 100	1	■	■		Reparaturset Repairkit	
50 120 000	2	■	■		Anschlußleitung mit AMP Stecker, 4m Cablekit with AMP connector, 4m	

Heckleuchte

Rear Combination Lamp

Typ: passend für M.A.N. / RENAULT / DAF

Funktion: Blink-, Stop-, Rück-, Nebelschluß-, Rückfahr-, Umriß-,
 Kennzeichen-, Seitenmarkierungsleuchte,
 Rückstrahler, Opt. LED Modul

Function: Dir.Indicator-, Stop-, Rear-, Fog-, Reverse-, End Outline
 Marker-, Numberplate-, Sidemarker Lamp,
 Reflex Reflector, Opt. LED Module

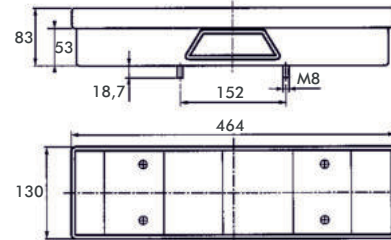

Artikel-Nr. Reference-No.	VE QTY	links left	rechts right	Kennz.- leuchte Numberplate- lamp	Beschreibung - Hersteller Referenz Specification - O.E.-No.	Anschlußsystem - Zubehör - Ersatzteile Connector - Accessories - Spare Parts
40 207 322	1		■		M.A.N. TG-A 81.25225.6523 RENAULT 5001847585	DAF 1625986 
40 207 323	1	■		■	M.A.N. TG-A 81.25225.6524 RENAULT 5001847584	DAF 1625985 
40 207 112	2	■	■		M.A.N. TG-A 81.25225.6524 RENAULT 5001847584 Lichtscheibe Lens	DAF 1625985
50 062 001	1	■	■		Einsatz Seitenmarkierungsleuchte Insert Sidemarker Lamp	
40 199 002	10	■	■		LED Modul Funktion: Schlußlicht/Umrißleuchte LED Unit Function Rear light/End Outline Marker	glowpoint BA 15s 
50 125 000	1	■	■		LED Kontroll Gerät LED Control Gear	
50 071 100	1	■	■		Reparaturset Repairkit	

Heckleuchte

Rear Combination Lamp

Typ: passend für M.A.N. / STEYR

Funktion: Blink-, Stop-, Rück-, Nebelschluß-, Rückfahr-, Umriß-, Kennzeichen-, Seitenmarkierungsleuchte, Rückstrahler, Opt. LED Modul

Function: Dir.Indicator-, Stop-, Rear-, Fog-, Reverse-, End Outline Marker-, Numberplate-, Sidemarker Lamp-, Reflex Reflector-, Opt. LED Module

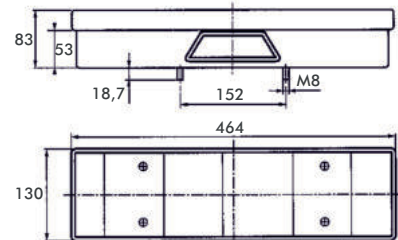

Artikel-Nr. Reference-No.	VE QTY	links left	rechts right	Kennz.- leuchte Numberplate- lamp	Beschreibung - Hersteller Referenz Specification - O.E.-No.	Anschlußsystem - Zubehör - Ersatzteile Connector - Accessories - Spare Parts
40 207 312	1		■		M.A.N. STEYR Gehäuse: 81.25228.6030 Gehäuse: 81.25225.6464 Lichtscheibe: 81.25229.6051	
40 207 313	1	■		■	M.A.N. STEYR Gehäuse: 81.25228.6029 Gehäuse: 81.25225.6465 Lichtscheibe: 81.25229.6051	
40 207 112	2	■	■		M.A.N. 81.25229.6051 STEYR 892.00.81.006 Lichtscheibe Lens	
50 062 001	1	■	■		Einsatz Seitenmarkierungsleuchte Insert Sidemarker Lamp	
40 199 002	10	■	■		LED Modul Funktion: Schlußlicht/Umrißleuchte LED Unit Function Rear light/End Outline Marker	glowpoint BA 15s
50 125 000	1	■	■		LED Kontroll Gerät LED Control Gear	
50 071 000	1	■	■		Reparaturset Repairkit	

Heckleuchte

Rear Combination Lamp

Typ: LC8 DAF
Funktion: Blink-, Stop-, Rück-, Nebelschluß-, Rückfahr-, Umriß-, Kennzeichen-, Seitenmarkierungsleuchte rot, Rückstrahler, Opt. Rückfahrwarner

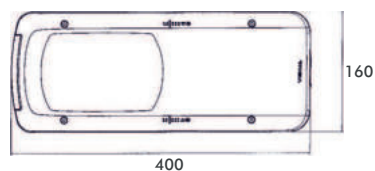
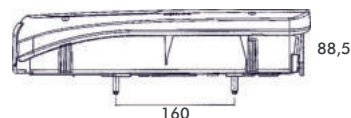
Function: Dir.Indicator-, Stop-, Rear-, Fog-, Reverse-, End Outline Marker-, Numberplate-, Sidemarker Lamp red, Reflex Reflector, Opt. Back Alarm System

Artikel-Nr. Reference-No.	VE QTY	links left	rechts right	Kennz.- leuchte Numberplate- lamp	Beschreibung - Hersteller Referenz Specification - O.E.-No.	Anschlußsystem - Zubehör - Ersatzteile Connector - Accessories - Spare Parts
40 253 312	1		■		DAF 1875576	
40 253 313	1	■		■	DAF 1875577	
40 253 315	1		■		DAF 1875578 Integrierter Rückfahrwarner Back Alarm System	
40 253 412	1		■		DAF 1875579	
40 253 413	1	■		■	DAF 1875580	
40 253 415	1		■		DAF 1875581 Integrierter Rückfahrwarner Back Alarm System	
40 253 131	1	■			DAF 1914690 Lichtscheibe Lens	
40 253 132	1		■		DAF 1914691 Lichtscheibe Lens	
50 068 000	1	■	■		Reparaturkit HDSCS Repairkit HDSCS	

Heckleuchte

Rear Combination Lamp

Typ: passend für DAF

Funktion: Blink-, Stop-, Rück-, Nebelschluß-, Rückfahr-, Umriß-,
 Kennzeichen-, Seitenmarkierungsleuchte,
 Rückstrahler, Opt. LED Modul

Function: Dir.Indicator-, Stop-, Rear-, Fog-, Reverse-, End Outline
 Marker-, Numberplate-, Sidemarker Lamp,
 Reflex Reflector, Opt. LED Module

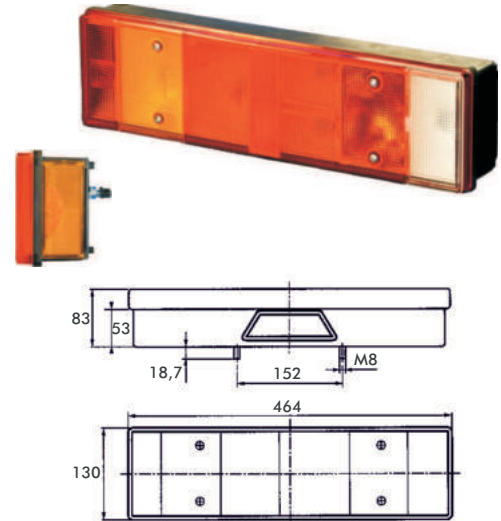

Artikel-Nr. Reference-No.	VE QTY	links left	rechts right	Kennz.- leuchte Numberplate- lamp	Beschreibung - Hersteller Referenz Specification - O.E.-No.	Anschlußsystem - Zubehör - Ersatzteile Connector - Accessories - Spare Parts
40 207 512	1	■	■		DAF 1284211	
40 207 513	1	■	■		DAF 1284212	
40 207 112	2	■	■		DAF 1272653 Lichtscheibe Lens	
50 062 001	1	■	■		Einsatz Seitenmarkierungsleuchte Insert Sidemarker Lamp	
40 199 002	10	■	■		LED Modul Funktion: Schlußlicht/Umrißleuchte LED Unit Function Rear light/End Outline Marker	glowpoint BA 15s
50 125 000	1	■	■		LED Kontroll Gerät LED Control Gear	

Heckleuchte

Rear Combination Lamp

Typ: passend für IVECO

Funktion: Blink-, Stop-, Rück-, Nebelschluß-, Rückfahr-, Umriß-, Kennzeichen-, Seitenmarkierungsleuchte, Rückstrahler, Opt. LED Modul

Function: Dir.Indicator-, Stop-, Rear-, Fog-, Reverse-, End Outline Marker-, Numberplate-, Sidemarker Lamp-, Reflex Reflector-, Opt. LED Module

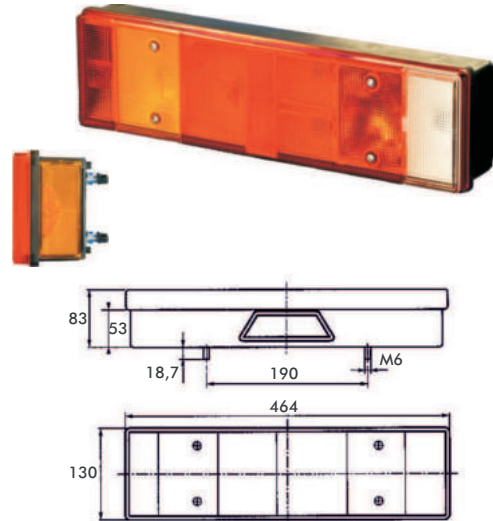

Artikel-Nr. Reference-No.	VE QTY	links left	rechts right	Kennz.- leuchte Numberplate- lamp	Beschreibung - Hersteller Referenz Specification - O.E.-No.	Anschlußsystem - Zubehör - Ersatzteile Connector - Accessories - Spare Parts
40 207 811	1	■			IVECO 99 46 32 43	
40 207 812	1		■		IVECO 99 46 32 42	
40 207 813	1	■		■	IVECO 99 46 32 44	
40 207 112	2	■	■		IVECO 99 46 18 44 Lichtscheibe Lens	
50 062 001	1	■	■		Einsatz Seitenmarkierungsleuchte Insert Sidemarker Lamp	
40 199 002	10	■	■		LED Modul Funktion: Schlußlicht/Umrißleuchte LED Unit Function Rear light/End Outline Marker	glowpoint BA 15s
50 125 000	1	■	■		LED Kontroll Gerät LED Control Gear	

Heckleuchte

Rear Combination Lamp

Typ: UNIVERSAL

Funktion: Blink-, Stop-, Rück-, Nebelschluß-, Rückfahr-, Umriß-,
 Kennzeichen-, Seitenmarkierungsleuchte,
 Rückstrahler, Opt. LED Modul

Function: Dir.Indicator-, Stop-, Rear-, Fog-, Reverse-, End Outline
 Marker-, Numberplate-, Sidemarker Lamp,
 Reflex Reflector, Opt. LED Module

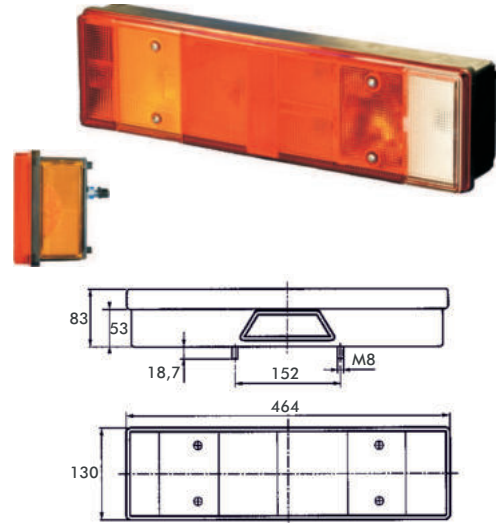

Artikel-Nr. Reference-No.	VE QTY	links left	rechts right	Kennz.- leuchte Numberplate- lamp	Beschreibung - Hersteller Referenz Specification - O.E.-No.	Anschlußsystem - Zubehör - Ersatzteile Connector - Accessories - Spare Parts
40 207 612	1	■	■		mit Rückstrahler with Reflex Reflector	
40 207 613	1	■		■	mit Rückstrahler with Reflex Reflector	
40 207 112	2	■	■		Lichtscheibe Lens	
50 062 001	1	■	■		Einsatz Seitenmarkierungsleuchte Insert Sidemarker Lamp	
40 199 002	10	■	■		LED Modul Funktion: Schlußlicht/Umrißleuchte LED Unit Function Rear light/End Outline Marker	glowpoint
50 125 000	1	■	■		LED Kontroll Gerät LED Control Gear	

Heckleuchte

Rear Combination Lamp

Typ: LC8 SCANIA P&R Serie

Funktion: Blink-, Stop-, Rück-, Nebelschluß-, Rückfahr-, Umriß-, Kennzeichen-, Seitenmarkierungsleuchte rot, Rückstrahler, Opt. Rückfahrwarner

Function: Dir.Indicator-, Stop-, Rear-, Fog-, Reverse-, End Outline Marker-, Numberplate-, Sidemarker Lamp red, Reflex Reflector, Opt. Back Alarm System

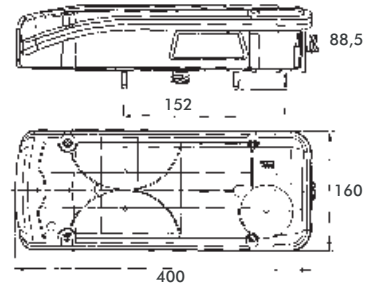

Artikel-Nr. Reference-No.	VE QTY	links left	rechts right	Kennz.- leuchte Numberplate- lamp	Beschreibung - Hersteller Referenz Specification - O.E.-No.	Anschlußsystem - Zubehör - Ersatzteile Connector - Accessories - Spare Parts
40 253 712	1		■		SCANIA 1756751	
40 253 713	1	■		■	SCANIA 1756754	
40 253 151	1	■			SCANIA 1784669 Lichtscheibe Lens	
40 253 152	1		■		SCANIA 1784670 Lichtscheibe Lens	
50 071 100	1	■	■		Reparaturset Repairkit	
50 120 000	2	■	■		Anschlußleitung mit AMP Stecker, 4m Cablekit with AMP connector, 4m	

Heckleuchte

Rear Combination Lamp

Typ: passend für SCANIA

Funktion: Blink-, Stop-, Rück-, Nebelschluß-, Rückfahr-, Umriß-, Kennzeichen-, Seitenmarkierungsleuchte, Rückstrahler, Opt. LED Modul

Function: Dir.Indicator-, Stop-, Rear-, Fog-, Reverse-, End Outline Marker-, Numberplate-, Sidemarker Lamp, Reflex Reflector, Opt. LED Module



Artikel-Nr. Reference-No.	VE QTY	links left	rechts right	Kennz.- leuchte Numberplate- lamp	Beschreibung - Hersteller Referenz Specification - O.E.-No.	Anschlußsystem - Zubehör - Ersatzteile Connector - Accessories - Spare Parts
40 223 312	1	■	■		SCANIA 1498103	
40 223 313	1	■	■		SCANIA 1498102	
40 223 112	1	■	■		SCANIA 1380819 Lichtscheibe <i>Lens</i>	
40 199 002	10	■	■		LED Modul Funktion: Schlußlicht/Umrißleuchte <i>LED Unit Function Rear light/End Outline Marker</i>	glowpoint BA 15s
50 125 000	1	■	■		LED Kontroll Gerät <i>LED Control Gear</i>	
50 071 100	1	■	■		Reparaturset <i>Repairkit</i>	

Heckleuchte

Rear Combination Lamp

Typ: passend für SCANIA

Funktion: Blink-, Stop-, Rück-, Nebelschluß-, Rückfahr-, Umriß-,
 Kennzeichen-, Seitenmarkierungsleuchte,
 Rückstrahler, Opt. LED Modul

Function: Dir.Indicator-, Stop-, Rear-, Fog-, Reverse-, End Outline
 Marker-, Numberplate-, Sidemarker Lamp,
 Reflex Reflector, Opt. LED Module



Artikel-Nr. Reference-No.	VE QTY	links left	rechts right	Kennz.- leuchte Numberplate- lamp	Beschreibung - Hersteller Referenz Specification - O.E.-No.	Anschlußsystem - Zubehör - Ersatzteile Connector - Accessories - Spare Parts
40 223 012	1		■		SCANIA 1380446/1397496/1436849 1436866/1504601/1504603	
40 223 013	1	■		■	SCANIA 1371974/1371976/1387877 1436851/1436854/1436867 1504605/1504608/1508178	
40 223 112	1	■	■		SCANIA 1380819 Lichtscheibe Lens	
40 199 002	10	■	■		LED Modul Funktion: Schlußlicht/Umrißleuchte LED Unit Function Rear light/End Outline Marker	glowpoint BA 15s
50 125 000	1	■	■		LED Kontroll Gerät LED Control Gear	

Heckleuchte

Rear Combination Lamp

Typ: passend für VOLVO

Funktion: Blink-, Stop-, Rück-, Nebelschluß-, Rückfahr-, Umriß-, Kennzeichen-, Seitenmarkierungsleuchte, Rückstrahler, Opt. LED Modul

Function: Dir.Indicator, Stop-, Rear-, Fog-, Reverse-, End Outline Marker-, Numberplate-, Sidemarker Lamp, Reflex Reflector, Opt. LED Module

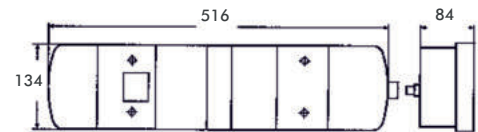
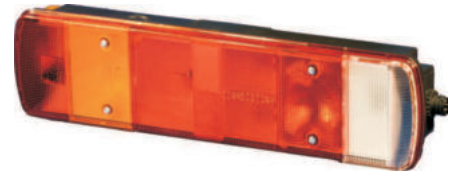

Artikel-Nr. Reference-No.	VE QTY	links left	rechts right	Kennz.- leuchte Numberplate- lamp	Beschreibung - Hersteller Referenz Specification - O.E.-No.	Anschlußsystem - Zubehör - Ersatzteile Connector - Accessories - Spare Parts
40 223 202	1	■	■		VOLVO 08/98 3981456/3981459/3981461 3981463	
40 223 203	1	■		■	VOLVO 08/98 3981455/3981460	
40 223 112	1	■	■		VOLVO 08/98 3981782 Lichtscheibe <i>Lens</i>	
40 199 002	10	■	■		LED Modul Funktion: Schlußlicht/Umrißleuchte <i>LED Unit Function Rear light/End Outline Marker</i>	glowpoint BA 15s
50 125 000	1	■	■		LED Kontroll Gerät <i>LED Control Gear</i>	
50 071 100	1	■	■		Reparaturset <i>Repairkit</i>	

Heckleuchte

Rear Combination Lamp

Typ: LC9 VOLVO / RENAULT

Funktion: Blink-, Stop-, Rück-, Nebelschluß-, Rückfahr-, Umriß-, Kennzeichen-, Seitenmarkierungsleuchte rot, Rückstrahler, Opt. Rückfahrwarner

Function: Dir.Indicator-, Stop-, Rear-, Fog-, Reverse-, End Outline Marker-, Numberplate-, Sidemarker Lamp red, Reflex Reflector, Opt. Back Alarm System

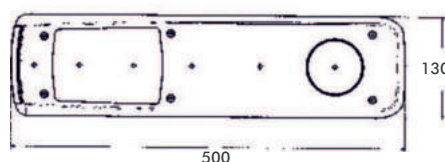
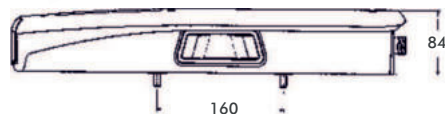

Artikel-Nr. Reference-No.	VE QTY	links left	rechts right	Kennz.- leuchte Numberplate- lamp	Beschreibung - Hersteller Referenz Specification - O.E.-No.	Anschlußsystem - Zubehör - Ersatzteile Connector - Accessories - Spare Parts
40 259 012	1		■		RENAULT 7420802350 Magnum,Premium,Kerax VOLVO 20802350 FE Serie >2006	
40 259 013	1	■		■	RENAULT 7420802348 Magnum,Premium,Kerax VOLVO 20802346 FE Serie >2006	
40 259 112	1	■	■		RENAULT 7420802418 Magnum,Premium,Kerax VOLVO 20802418 FE Serie >2006 Lichtscheibe Lens	
50 071 100	1	■	■		Reparaturset Repairkit	
50 120 000	2	■	■		Anschlußleitung mit AMP Stecker, 4m Cablekit with AMP connector, 4m	

Heckleuchte

Rear Combination Lamp

Typ: passend für VOLVO

Funktion: Blink-, Stop-, Rück-, Nebelschluß-, Rückfahr-, Umriß-,
 Kennzeichen-, Seitenmarkierungsleuchte,
 Rückstrahler

Function: Dir.Indicator-, Stop-, Rear-, Fog-, Reverse-, End Outline
 Marker-, Numberplate-, Sidemarker Lamp,
 Reflex Reflector

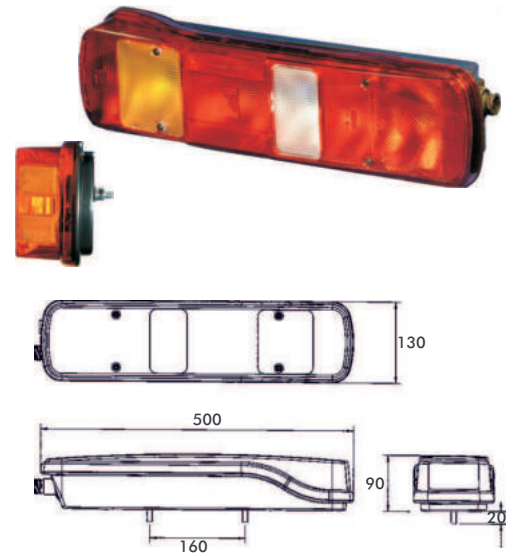

Artikel-Nr. Reference-No.	VE QTY	links left	rechts right	Kennz.- leuchte Numberplate- lamp	Beschreibung - Hersteller Referenz Specification - O.E.-No.	Anschlußsystem - Zubehör - Ersatzteile Connector - Accessories - Spare Parts
40 257 012	1		■		VOLVO 20565106	
40 257 013	1	■		■	VOLVO 20565103	
40 257 112	1	■	■		VOLVO 20565107 Lichtscheibe Lens	
50 071 100	1	■	■		Reparaturset Repairkit	

Heckleuchte



Rear Combination Lamp

Typ: passend für VOLVO

Funktion: Blink-, Stop-, Rück-, Nebelschluß-, Rückfahr-, Umriß-,
 Kennzeichen-, Seitenmarkierungsleuchte,
 Rückstrahler

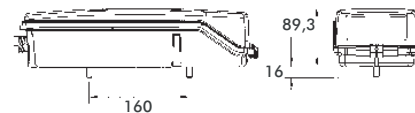
Function: Dir.Indicator-, Stop-, Rear-, Fog-, Reverse-, End Outline
 Marker-, Numberplate-, Sidemarker Lamp,
 Reflex Reflector



Artikel-Nr. Reference-No.	VE QTY	links left	rechts right	Kennz.- leuchte Numberplate- lamp	Beschreibung - Hersteller Referenz Specification - O.E.-No.	Anschlußsystem - Zubehör - Ersatzteile Connector - Accessories - Spare Parts
40 251 012	1		■		VOLVO 20507624/20425729	
40 251 013	1	■		■	VOLVO 20507623/20425728	
40 251 112	1	■	■		VOLVO 20425732 Lichtscheibe Lens	
50 071 100	1	■	■		Reparaturset Repairkit	

Heckleuchte

Rear Combination Lamp

Typ: LC8 MB SPRINTER / VW CRAFTER

Funktion: Blink-, Stop-, Rück-, Nebelschluß-, Rückfahr-, Umriß-,
 Kennzeichen-, Seitenmarkierungsleuchte rot,
 Rückstrahler

Function: Dir.Indicator-, Stop-, Rear-, Fog-, Reverse-, End Outline
 Marker-, Numberplate-, Sidemarker Lamp red,
 Reflex Reflector

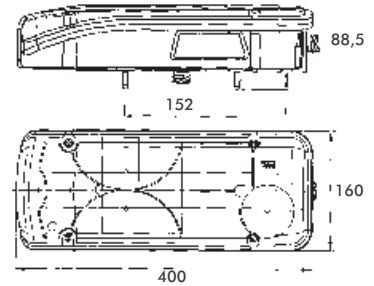

Artikel-Nr. Reference-No.	VE QTY	links left	rechts right	Kennz.- leuchte Numberplate- lamp	Beschreibung - Hersteller Referenz Specification - O.E.-No.	Anschlußsystem - Zubehör - Ersatzteile Connector - Accessories - Spare Parts
40 253 512	1		■		MB A906 820 1764ET VW 2E0 945 096 A	
40 253 513	1	■		■	MB A906 820 0464ET VW 2E0 945 095 A	
40 253 151	1	■			MB A000 826 2056 VW 2E0 945 111 Lichtscheibe Lens	
40 253 152	1		■		MB A006 826 2156 VW 2E0 945 112 Lichtscheibe Lens	
50 071 100	1	■	■		Reparaturset Repairkit	
50 120 000	2	■	■		Anschlußleitung mit AMP Stecker, 4m Cablekit with AMP connector, 4m	

Heckleuchte

Rear Combination Lamp

Typ: passend für MERCEDES BENZ ACTROS

Funktion: Blink-, Stop-, Rück-, Nebelschluß-, Rückfahr-, Umriß-, Kennzeichen-, Seitenmarkierungsleuchte, Rückstrahler, Opt. LED Modul

Function: Dir.Indicator-, Stop-, Rear-, Fog-, Reverse-, End Outline Marker-, Numberplate-, Sidemarker Lamp, Reflex Reflector, Opt. LED Module

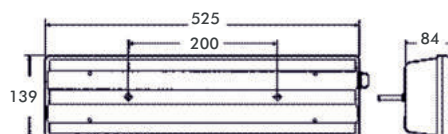

Artikel-Nr. Reference-No.	VE QTY	links left	rechts right	Kennz.- leuchte Numberplate- lamp	Beschreibung - Hersteller Referenz Specification - O.E.-No.	Anschlußsystem - Zubehör - Ersatzteile Connector - Accessories - Spare Parts	
40 220 202	1		■		MB ACTROS 001 540 6370		
40 220 203	1	■		■	MB ACTROS 001 540 6270		
40 219 111	1	■			Lichtscheibe Lens		
40 219 112	1		■		Lichtscheibe Lens		
50 062 001	1	■	■		Einsatz Seitenmarkierungsleuchte Insert Sidemarker Lamp		
40 199 002	10	■	■		LED Modul Funktion: Schlußlicht/Umrißleuchte LED Unit Function Rear light/End Outline Marker	glowpoint	BA 15s
50 125 000	1	■	■		LED Kontroll Gerät LED Control Gear		
50 071 100	1	■	■		Reparaturset Repairkit		

Heckleuchte

Rear Combination Lamp





Typ: passend für MERCEDES BENZ SK

Funktion: Blink-, Stop-, Rück-, Nebelschluß-, Rückfahr-, Umriß-, Kennzeichen-, Seitenmarkierungsleuchte, Rückstrahler, Opt. LED Modul

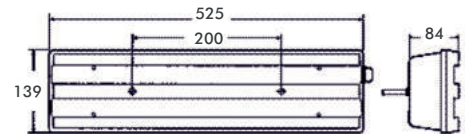
Function: Dir.Indicator-, Stop-, Rear-, Fog-, Reverse-, End Outline Marker-, Numberplate-, Sidemarker Lamp-, Reflex Reflector, Opt. LED Module



Artikel-Nr. Reference-No.	VE QTY	links left	rechts right	Kennz.- leuchte Numberplate- lamp	Beschreibung - Hersteller Referenz Specification - O.E.-No.	Anschlußsystem - Zubehör - Ersatzteile Connector - Accessories - Spare Parts
40 220 002	1		■		MB ACTROS 001 540 1870 Kabel 1,2m mit Anschlußstecker Cable 1,2m with connector	
40 220 003	1	■		■	MB ACTROS 001 540 1770 Kabel 1,2m mit Anschlußstecker Cable 1,2m with connector	
40 219 111	1	■			MB ACTROS 002 544 1290 Lichtscheibe Lens	
40 219 112	1		■		MB ACTROS 002 544 1390 Lichtscheibe Lens	
50 062 001	1	■	■		Einsatz Seitenmarkierungsleuchte Insert Sidemarker Lamp	
40 199 002	10	■	■		LED Modul Funktion: Schlußlicht/Umrißleuchte LED Unit Function Rear light/End Outline Marker	glowpoint BA 15s 
50 125 000	1	■	■		LED Kontroll Gerät LED Control Gear	

Heckleuchte

Rear Combination Lamp

**Typ: passend für MERCEDES BENZ
SPRINTER / ATEGO**

Funktion: Blink-, Stop-, Rück-, Nebelschluß-, Rückfahr-, Umriß-,
Kennzeichenleuchte, Rückstrahler, Opt. LED Modul

Function: Dir.Indicator-, Stop-, Rear-, Fog-, Reverse-, End Outline
Marker-, Numberplate Lamp, Reflex Reflector,
Opt. LED Module

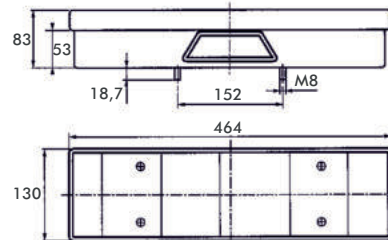

Artikel-Nr. Reference-No.	VE QTY	links left	rechts right	Kennz.- leuchte Numberplate- lamp	Beschreibung - Hersteller Referenz Specification - O.E.-No.	Anschlußsystem - Zubehör - Ersatzteile Connector - Accessories - Spare Parts
40 228 012	1	■	■		MB SPRINTER A 002 544 5403	
40 228 013	1	■		■	MB SPRINTER A 002 544 5503	
40 230 212	1	■	■		MB ATEGO A 002 544 5403/-5703	
40 230 213	1	■		■	MB ATEGO A 002 544 5503/-5603	
40 228 112	1	■	■		MB A 003 544 4790 Lichtscheibe Lens	
40 199 002	10	■	■		LED Modul Funktion: Schlußlicht/Umrißleuchte LED Unit Function Rear light/End Outline Marker	glowpoint BA 15s
50 125 000	1	■	■		LED Kontroll Gerät LED Control Gear	
50 071 000	1	■	■		Reparaturset Repairkit	

Heckleuchte

Rear Combination Lamp

Typ: passend für MERCEDES BENZ ATEGO
mit Ladeklappe / with Tailboard

Funktion: Blink-, Stop-, Rück-, Nebelschluß-, Rückfahr-,
Kennzeichenleuchte, Rückstrahler

Function: Dir.Indicator-, Stop-, Rear-, Fog-, Reverse-,
Numberplate Lamp, Reflex Reflector

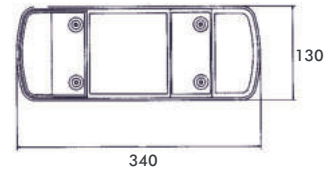

Artikel-Nr. Reference-No.	VE QTY	links left	rechts right	Kennz.- leuchte Numberplate- lamp	Beschreibung - Hersteller Referenz Specification - O.E.-No.	Anschlußsystem - Zubehör - Ersatzteile Connector - Accessories - Spare Parts
40 231 212	1	■	■		MB 002 544 6903 / 7103	
40 231 213	1	■		■	MB 002 544 6803 / 7003	
40 231 112	2	■	■		MB 002 544 6190 Lichtscheibe Lens	
50 071 000	1	■	■		Reparaturset Repairkit	

Heckleuchte

Rear Combination Lamp





Typ: passend für KÖGEL / SCHMITZ

Funktion: Blink-, Stop-, Rück-, Nebelschluß-, Rückfahr-,
Seitenmarkierungsleuchte

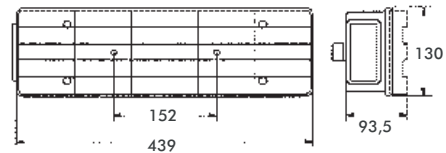
Function: Dir.Indicator-, Stop-, Rear-, Fog-, Reverse-,
Sidemarker Lamp

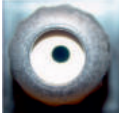

Artikel-Nr. Reference-No.	VE QTY	links left	rechts right	Kennz.- leuchte Numberplate- lamp	Beschreibung - Hersteller Referenz Specification - O.E.-No.	Anschlußsystem - Zubehör - Ersatzteile Connector - Accessories - Spare Parts
40 217 002	1	■	■		Kögel 324 944 Schmitz 062 345 / 062 423 Anschlußstecker 6-polig Connector 6-poles	
40 217 202	1	■	■		Kögel 333 423 Kabel 1,44m + Stecker 6-polig Cable 1,44m + connector 6-poles	
40 217 302	1	■	■		PG-Verschraubung PG-Screw	
40 217 102	1	■	■		Kögel 324 945 Schmitz 062 447 Lichtscheibe Lens	

Heckleuchte

Rear Combination Lamp

**Typ: passend für MERCEDES BENZ /
KRUNE / SCHMITZ**

Funktion: Blink-, Stop-, Rück-, Nebelschluß-, Rückfahr-,
Kennzeichenleuchte, Rückstrahler

Function: Dir.Indicator-, Stop-, Rear-, Fog-, Reverse-,
Numberplate Lamp, Reflex Reflector

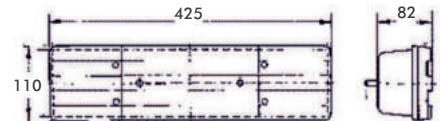

Artikel-Nr. Reference-No.	VE QTY	links left	rechts right	Kennz.- leuchte Numberplate- lamp	Nebels- leuchte Fog- lamp	Rückfahr- leuchte Reversing lamp	Beschreibung - Hersteller Referenz Specification - O.E.-No.	Anschlußsys. - Ersatzteile Connector - Spare Parts
40 218 011	1	■			■		MERCEDES BENZ 208 D - 410 ab 03/89 507 D - 814 D ab 01/86	
40 218 012	1		■			■	MERCEDES BENZ 208 D - 410 ab 03/89 507 D - 814 D ab 01/86	
40 218 013	1	■		■	■		MERCEDES BENZ 208 D - 410 ab 03/89 507 D - 814 D ab 01/86	
40 218 111	2	■	■		■		MERCEDES BENZ 208 D - 410 ab 03/89 507 D - 814 D ab 01/86 Lichtscheibe Lens	
40 218 112	2	■	■			■	MERCEDES BENZ 208 D - 410 ab 03/89 507 D - 814 D ab 01/86 Lichtscheibe Lens	

Heckleuchte

Rear Combination Lamp

**Typ: LC4 RENAULT / DAF /
FRUEHAUF**

Funktion: Blink-, Stop-, Rück-, Nebelschluß-, Rückfahr-,
Kennzeichenleuchte

Function: Dir.Indicator-, Stop-, Rear-, Fog-, Reverse-,
Numberplate Lamp

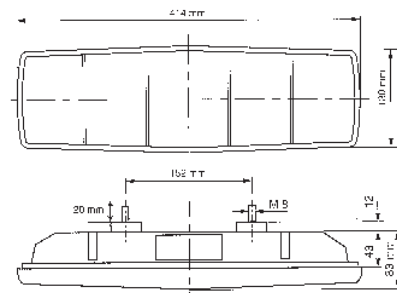

Artikel-Nr. Reference-No.	VE QTY	links left	rechts right	Kennz.- leuchte Numberplate- lamp	Beschreibung - Hersteller Referenz Specification - O.E.-No.	Anschlußsystem - Zubehör - Ersatzteile Connector - Accessories - Spare Parts
40 209 003	1	■	■	■ mit Abdeckung with cover	DAF FRUEHAUF 0292052 LFA2668-701 ohne Rückstrahler without Reflex Reflector	
40 209 013	1	■	■	■ mit Abdeckung with cover	DAF RENAULT 0292052 5000808172 mit Rückstrahler with Reflex Reflector	
40 209 103	1	■	■		DAF RENAULT 0689052 5000807304 Lichtscheibe ohne Rückstrahler Lens without Reflex Reflector	
40 209 113	1	■	■		DAF RENAULT 069860 5000808166 Lichtscheibe mit Rückstrahler Lens with Reflex Reflector	

Heckleuchte

Rear Combination Lamp

**Typ: LC5 UNIVERSAL / RENAULT
NISSAN / DAF**

Funktion: Blink-, Stop-, Rück-, Nebelschluß-, Rückfahr-,
Kennzeichenleuchte, Rückstrahler

Function: Dir.Indicator, Stop-, Rear-, Fog-, Reverse-,
Numberplate Lamp, Reflex Reflector

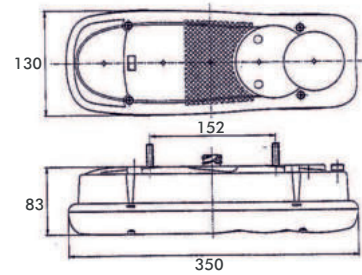

Artikel-Nr. Reference-No.	VE QTY	links left	rechts right	Kennz.- leuchte Numberplate- lamp	Beschreibung - Hersteller Referenz Specification - O.E.-No.	Anschlußsystem - Zubehör - Ersatzteile Connector - Accessories - Spare Parts	
40 243 001	1	■	■				
40 243 202	1		■		RENAULT 5001846848 5001846849	DAF 1401713 NISSAN	
40 243 203	1	■		■	RENAULT 5001846847 5001846850	DAF 1401713 NISSAN	
40 243 102	2	■	■		Lichtscheibe ohne Rückstrahler <i>Lens without Reflex Reflector</i>		
40 243 112	2	■	■		RENAULT 5001847153	DAF 1451482 NISSAN	
50 071 100	1	■	■		Reparaturset <i>Repairkit</i>		

Heckleuchte

Rear Combination Lamp

**Typ: 5-Kammerleuchte
ohne Rückstrahler**

Funktion: Blink-, Stop-, Rück-, Nebelschluß-, Rückfahr-,
Kennzeichenleuchte
ohne Rückstrahler

Function: Dir.Indicator-, Stop-, Rear-, Fog-, Reverse-,
Numberplate Lamp
without Reflex Reflector

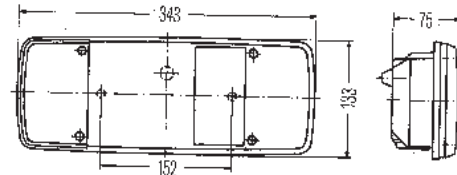
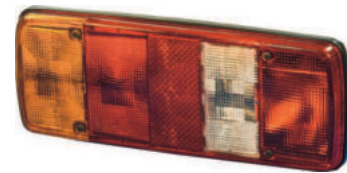

Artikel-Nr. Reference-No.	VE QTY	links left	rechts right	Kennz.- leuchte Numberplate- lamp	Beschreibung - Hersteller Referenz Specification - O.E.-No.	Anschlußsystem - Zubehör - Ersatzteile Connector - Accessories - Spare Parts
40 204 001	1	■				
40 204 002	1		■			
40 204 003	1	■		■		
40 204 004	1		■	■		
40 204 102	2	■	■		Lichtscheibe Lens	

Heckleuchte

Rear Combination Lamp





Typ: 5-Kammerleuchte mit Rückstrahler

Funktion: Blink-, Stop-, Rück-, Nebelschluß-, Rückfahr-, Kennzeichenleuchte mit Rückstrahler

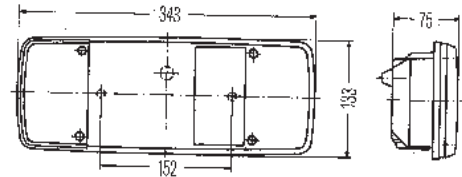
Function: Dir.Indicator-, Stop-, Rear-, Fog-, Reverse-, Numberplate Lamp with Reflex Reflector



Artikel-Nr. Reference-No.	VE QTY	links left	rechts right	Kennz.- leuchte Numberplate- lamp	Beschreibung - Hersteller Referenz Specification - O.E.-No.	Anschlußsystem - Zubehör - Ersatzteile Connector - Accessories - Spare Parts
40 204 011	1	■				
40 204 012	1		■			
40 204 013	1	■		■		
40 204 112	2	■	■		Lichtscheibe für Ausführung Lens for Reference 40 204 011, 40 204 012, 40 204 013	

Heckleuchte

Rear Combination Lamp

Typ: passend für IVECO - DAILY

Funktion: Blink-, Stop-, Rück-, Nebelschluß-, Rückfahrleuchte, Rückstrahler

Function: Dir.Indicator-, Stop-, Rear-, Fog-, Reverse Lamp, Reflex Reflector

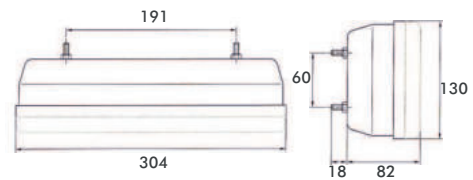

Artikel-Nr. Reference-No.	VE QTY	links left	rechts right	Kennz.- leuchte Numberplate- lamp	Beschreibung - Hersteller Referenz Specification - O.E.-No.	Anschlußsystem - Zubehör - Ersatzteile Connector - Accessories - Spare Parts
40 279 011	1	■			IVECO 69500032	
40 279 012	1		■		IVECO 69500026	
40 279 112	1	■	■		Lichtscheibe Lens	

Heckleuchte

Rear Combination Lamp

Typ: passend für IVECO - DAILY / EUROCARGO

Funktion: Blink-, Stop-, Rück-, Nebelschluß-, Rückfahrleuchte, Rückstrahler

Function: Dir.Indicator-, Stop-, Rear-, Fog-, Reverse Lamp, Reflex Reflector

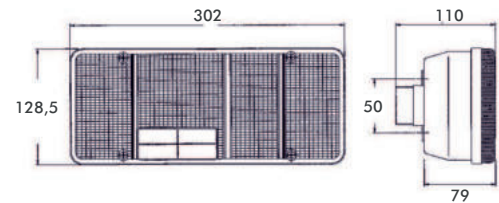

Artikel-Nr. Reference-No.	VE QTY	links left	rechts right	Kennz.- leuchte Numberplate- lamp	Nebels- leuchte Fog- lamp	Rückfahr- leuchte Reversing lamp	Beschreibung - Hersteller Referenz Specification - O.E.-No.	Anschlußsys. - Ersatzteile Connector - Spare Parts
40 211 011	1	■			■		4808775/73	
40 211 012	1		■			■	4808774/72	
40 211 211	1	■			■		98424052	
40 211 212	1		■			■	98424051	
40 211 311	1	■			■		500356783 Daily S2000 10/99	
40 211 312	1		■			■	500356782 Daily S2000 10/99	
40 211 111	2	■			■		7984796 Lichtscheibe Lens	
40 211 112	2		■			■	7984797 Lichtscheibe Lens	
40 211 113	2	■				■	7984794 Lichtscheibe Lens	
40 211 114	2		■		■		Lichtscheibe Lens	

Heckleuchte

Rear Combination Lamp



Typ: ECOPOINT

Funktion: Blink-, Stop-, Rück-, Nebelschluß-, Rückfahr-, Kennzeichenleuchte, Rückstrahler

Function: Dir.Indicator-, Stop-, Rear-, Fog-, Reverse-, Numberplate- Lamp, Reflex Reflector

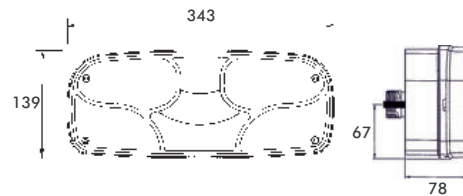

Artikel-Nr. Reference-No.	VE QTY	links left	rechts right	Kennz.- leuchte Numberplate- lamp	Beschreibung - Hersteller Referenz Specification - O.E.-No.	Anschlußsystem - Zubehör - Ersatzteile Connector - Accessories - Spare Parts
40 241 211	1	■			Aspöck 25-2000-507 mit Glühlampen bestückt with bulbs fitted	
40 241 212	1		■		Aspöck 25-2400-507 mit Glühlampen bestückt with bulbs fitted	
40 241 112	2	■	■		Aspöck 18-8520-002 Lichtscheibe Lens	
50 047 001	1	■			Aspöck 13-5626-941 Anschlußstecker gelb, passend für Aspöck ASS1 & ASS2 Stecker Connector yellow, for Aspöck ASS1 & ASS2 connector system	
50 047 002	1		■		Aspöck 13-5626-951 Anschlußstecker grün, passend für Aspöck ASS1 & ASS2 Stecker Connector green, for Aspöck ASS1 & ASS2 connector system	

Heckleuchte



Rear Combination Lamp

Typ: 3-Kammerleuchte

Funktion: Blink-, Stop-, Rück-, Kennzeichenleuchte

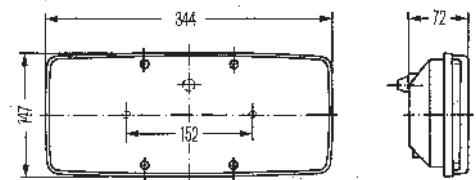
Function: Dir.Indicator-, Stop-, Rear-, Numberplate Lamp



Artikel-Nr. Reference-No.	VE QTY	links left	rechts right	Kennz.- leuchte Numberplate- lamp	Beschreibung - Hersteller Referenz Specification - O.E.-No.	Anschlußsystem - Zubehör - Ersatzteile Connector - Accessories - Spare Parts
40 206 002	1	■	■			
40 206 003	1	■		■		
40 206 004	1		■	■		
40 206 102	2	■	■		Lichtscheibe Lens	

Heckleuchte

Rear Combination Lamp

Typ: 3-Kammerleuchte

Funktion: Blink-, Stop-, Rück-, Kennzeichenleuchte



Function: Dir.Indicator-, Stop-, Rear-, Numberplate Lamp

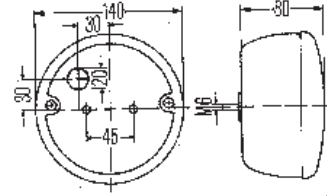

Artikel-Nr. Reference-No.	VE QTY	links left	rechts right	Kennz- leuchte Numberplate- lamp	Beschreibung - Hersteller Referenz Specification - O.E.-No.	Anschlußsystem - Zubehör - Ersatzteile Connector - Accessories - Spare Parts
40 202 001	1	■	■			
40 202 003	1	■	■	■		
40 202 102	2	■	■		Lichtscheibe Lens	

Typ: 3-Kammerleuchte

Funktion: Blink-, Stop-, Rück-, Kennzeichenleuchte



Function: Dir.Indicator-, Stop-, Rear-, Numberplate Lamp

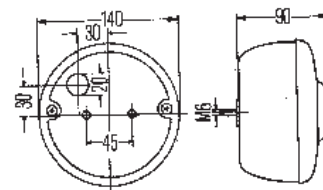

Artikel-Nr. Reference-No.	VE QTY	links left	rechts right	Kennz- leuchte Numberplate- lamp	Beschreibung - Hersteller Referenz Specification - O.E.-No.	Anschlußsystem - Zubehör - Ersatzteile Connector - Accessories - Spare Parts
40 201 001	1	■	■			

Heckleuchte





Rear Combination Lamp

Typ: MIDIPOINT

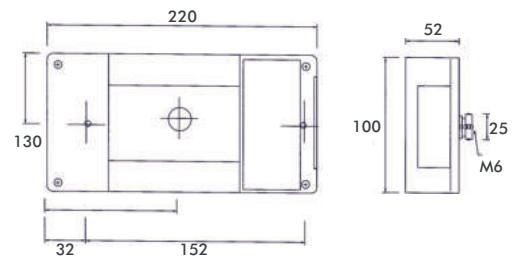
Funktion: Blink-, Stop-, Rück-, Nebelschluß-, Rückfahr-,
Kennzeichenleuchte, Rückstrahler
Glühlampenbestückung 12V

Function: Dir.Indicator, Stop-, Rear-, Fog-, Reverse-,
Numberplate Lamp, Reflex Reflector
Bulbs 12V fitted



Artikel-Nr. Reference-No.	VE QTY	links left	rechts right	Kennz.- leuchte Numberplate- lamp	Nebels- leuchte Fog- lamp	Rückfahr- leuchte Reversing lamp	Beschreibung - Hersteller Referenz Specification - O.E.-No.	Anschlußsys. - Ersatzteile Connector - Spare Parts
40 239 011	1	■		■ seitlich/ lateral	■		Aspöck 24-6000-007	
40 239 012	1		■	■ seitlich/ lateral			Aspöck 24-6200-007	
40 239 014	1		■	■ seitlich/ lateral		■	Aspöck 24-6210-007	
40 239 111	1	■	■		■		Aspöck 18-8460-007 Lichtscheibe Lens	
40 239 114	1		■			■	Aspöck 18-8462-107 Lichtscheibe Lens	
50 047 000	1	■	■				Aspöck 13-0546-004 Reparaturset Repairkit	

Heckleuchte

Rear Combination Lamp



Typ: 4-Kammerleuchte

Funktion: Blink-, Stop-, Rück-, Nebelschluß-, Rückfahr-, Kennzeichenleuchte, Rückstrahler

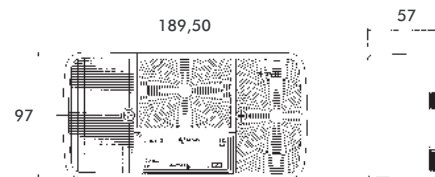

Function: Dir.Indicator-, Stop-, Rear-, Fog-, Reverse-, Numberplate Lamp, Reflex Reflector

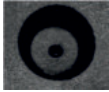

Artikel-Nr. Reference-No.	VE QTY	links left	rechts right	Kennz.- leuchte Numberplate- lamp	Nebels.- leuchte Fog- lamp	Rückfahr- leuchte Reversing lamp	Beschreibung - Hersteller Referenz Specification - O.E.-No.	Anschlußsys. - Ersatzteile Connector - Spare Parts
40 222 013	1	■		■ seitlich/ lateral	■			
40 222 014	1		■	■ seitlich/ lateral		■		
40 222 015	1		■	■ seitlich/ lateral	■			
40 222 111	2	■			■			
40 222 112	2		■			■		
40 222 115	2		■		■			

Heckleuchte

Rear Combination Lamp

Typ: MINIPPOINT

Funktion: Blink-, Stop-, Rück-, Kennzeichenleuchte

Function: Dir.Indicator-, Stop-, Rear-, Numberplate Lamp

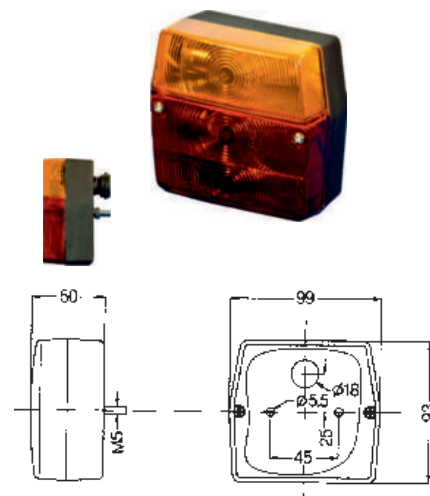

Artikel-Nr. Reference-No.	VE QTY	links left	rechts right	Kennz- leuchte Numberplate- lamp	Beschreibung - Hersteller Referenz Specification - O.E.-No.	Anschlußsystem - Zubehör - Ersatzteile Connector - Accessories - Spare Parts
40 225 001	1	■	■	■ mit Abdeckung with cover	Aspöck 23-0300-037	
40 225 201	1	■	■		Aspöck 23-0200-507 mit Glühlampen 12V bestückt with bulbs 12V fitted	
40 225 203	1	■	■	■	Aspöck 23-0300-507 mit Glühlampen 12V bestückt with bulbs 12V fitted	
40 225 102	2	■	■	■ mit Abdeckung with cover	Aspöck 18-8300-007 Lichtscheibe Lens	
50 047 000	1	■	■		Aspöck 13-0546-004 Reparaturkit Repairkit	

Typ: 3-Kammerleuchte

Funktion: Blink-, Stop-, Rück-, Kennzeichenleuchte

Function: Dir.Indicator-, Stop-, Rear-, Numberplate Lamp

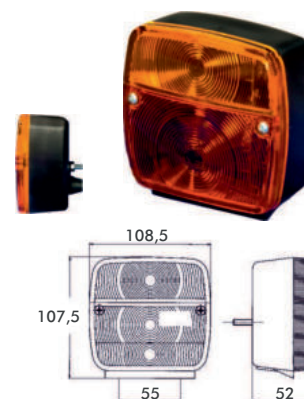

Artikel-Nr. Reference-No.	VE QTY	links left	rechts right	Kennz- leuchte Numberplate- lamp	Beschreibung - Hersteller Referenz Specification - O.E.-No.	Anschlußsystem - Zubehör - Ersatzteile Connector - Accessories - Spare Parts
40 305 204	1	■	■	■		
40 305 224	1	■	■			
40 305 214	2	■	■		Lichtscheibe Lens	

Heckleuchte

Rear Combination Lamp

Typ: 7-Kammerleuchte

Funktion: Blink-, Stop-, Rück-, Nebelschluß-, Rückfahr-, Umriß-, Kennzeichen-, Seitenmarkierungsleuchte, Dreieckrückstrahler

Function: Dir.Indicator-, Stop-, Rear-, Fog-, Reverse-, End Outline Marker-, Numberplate-, Sidemarker Lamp, Triangle Reflex Reflector

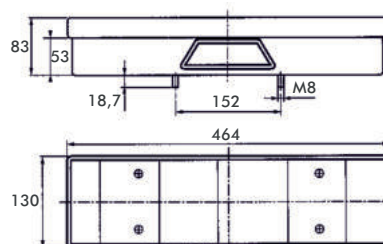
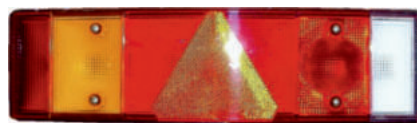

Artikel-Nr. Reference-No.	VE QTY	links left	rechts right	Kennz.- leuchte Numberplate- lamp	Beschreibung - Hersteller Referenz Specification - O.E.-No.	Anschlußsystem - Zubehör - Ersatzteile Connector - Accessories - Spare Parts
40 237 611	1	■				
40 237 612	1		■			
40 237 111	2	■			Lichtscheibe Lens	
40 237 112	2		■		Lichtscheibe Lens	
50 062 001	1	■	■		Einsatz Seitenmarkierungsleuchte Insert Sidemarker Lamp	

LED Heckleuchte

LED Rear Combination Lamp

Typ: EUROPOINT III 24V IP56K

Funktion: LED Schlusslicht - Bremslicht - Blinklicht -
 Rückfahrleuchte - Nebelschlussleuchte -
 Seitenmarkierungsleuchte - Dreieckrückstrahler

Function: LED Tail Lamp - Stop Lamp - Dir. Indicator Lamp -
 Reversing Lamp - Fog Lamp - Side Marker Lamp -
 Triangle Reflex Reflector

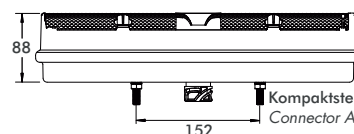
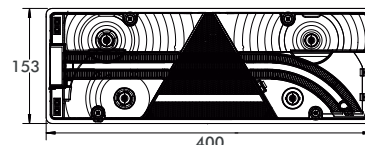

Artikel-Nr. Reference-No.	VE QTY	links left	rechts right	Kennz.- leuchte Numberplate- lamp	Beschreibung - Hersteller Referenz Specification - O.E.-No.	Anschlußsystem - Zubehör - Ersatzteile Connector - Accessories - Spare Parts
40 296 211	1	■			Aspöck 25-7000-501 Ausführung mit Aspöck ASS2 Stecker version with Aspöck ASS2 connector	
40 296 212	1		■		Aspöck 25-7400-501 Ausführung mit Aspöck ASS2 Stecker version with Aspöck ASS2 connector	
40 296 111	1	■			Aspöck 18-8570-001 Lichtscheibe <i>Lens</i>	
40 296 112	1		■		Aspöck 18-8570-101 Lichtscheibe <i>Lens</i>	
50 047 001	1	■			Aspöck 13-5626-941 Anschlußstecker gelb, passend für Aspöck ASS1 & ASS2 Stecker Connector yellow, for Aspöck ASS1 & ASS2 connector system	
50 047 002	1		■		Aspöck 13-5626-951 Anschlußstecker grün, passend für Aspöck ASS1 & ASS2 Stecker Connector green, for Aspöck ASS1 & ASS2 connector system	

Heckleuchte

Rear Combination Lamp



Typ: EUROPOINT II 24V

Funktion: Blink-, Stop-, Rück-, Nebelschluß-, Rückfahr-, Umriß-, Kennzeichen-, Seitenmarkierungsleuchte, Dreieckrückstrahler, Opt. LED Modul

Function: Dir.Indicator-, Stop-, Rear-, Fog-, Reverse-, End Outline Marker-, Numberplate-, Sidemarker Lamp-, Triangle Reflex Reflector-, Opt. LED Module

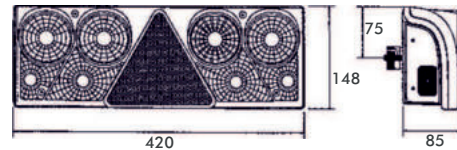

Artikel-Nr. Reference-No.	VE QTY	links left	rechts right	Kennz.- leuchte Numberplate- lamp	Beschreibung - Hersteller Referenz Specification - O.E.-No.	Anschlußsystem - Zubehör - Ersatzteile Connector - Accessories - Spare Parts
40 255 211	1	■			Aspöck 25-6000-507 mit Glühlampen bestückt with bulbs fitted	
40 255 212	1		■		Aspöck 25-6400-507 mit Glühlampen bestückt with bulbs fitted	
40 255 213	1	■		■	Aspöck 25-6001-507 mit Glühlampen bestückt with bulbs fitted	
40 255 112	2	■	■		Aspöck 18-8560-002 Lichtscheibe Lens	
50 047 001	1	■			Aspöck 13-5626-941 Anschlußstecker gelb, passend für Aspöck ASS1 & ASS2 Stecker Connector yellow, for Aspöck ASS1 & ASS2 connector system	
50 047 002	1		■		Aspöck 13-5626-951 Anschlußstecker grün, passend für Aspöck ASS1 & ASS2 Stecker Connector green, for Aspöck ASS1 & ASS2 connector system	
50 090 100	1	■	■		Rückfahrwarner für Einbau im Leuchtengehäuse Back Alarm System to fit into the Rear Lamp Housing	

Heckleuchte

Rear Combination Lamp



Typ: EUROPOINT II 24V

Funktion: Blink-, Stop-, Rück-, Nebelschluß-, Rückfahr-, Umriß-,
 Kennzeichen-, Seitenmarkierungsleuchte,
 Dreieckrückstrahler, Opt. LED Modul

Function: Dir.Indicator-, Stop-, Rear-, Fog-, Reverse-, End Outline
 Marker-, Numberplate-, Sidemarker Lamp,
 Triangle Reflex Reflector, Opt. LED Module

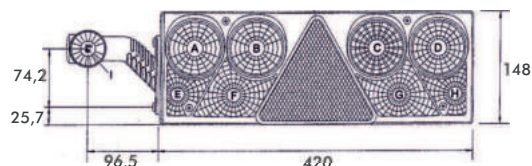

Artikel-Nr. Reference-No.	VE QTY	links left	rechts right	Kennz.- leuchte Numberplate- lamp	Beschreibung - Hersteller Referenz Specification - O.E.-No.	Anschlußsystem - Zubehör - Ersatzteile Connector - Accessories - Spare Parts
40 255 311	1	■			Aspöck 25-6011-517 mit Glühlampen bestückt <i>with bulbs fitted</i>	
40 255 312	1		■		Aspöck 25-6411-517 mit Glühlampen bestückt <i>with bulbs fitted</i>	
40 255 321	1	■			Aspöck 25-6021-737 LED Brems-Blink-Schlußlicht + LED Umrißl. + LED SML <i>LED Stop-Tail-Dir.Indicator + LED Outline Marker + LED SML</i>	
40 255 322	1		■		Aspöck 25-6421-737 LED Brems-Blink-Schlußlicht + LED Umrißl. + LED SML <i>LED Stop-Tail-Dir.Indicator + LED Outline Marker + LED SML</i>	
40 255 112	2	■	■		Aspöck 18-8560-002 Lichtscheibe <i>Lens</i>	
50 047 001	1	■			Aspöck 13-5626-941 Anschlußstecker gelb, passend für Aspöck ASS1 & ASS2 Stecker <i>Connector yellow, for Aspöck ASS1 & ASS2 connector system</i>	
50 047 002	1		■		Aspöck 13-5626-951 Anschlußstecker grün, passend für Aspöck ASS1 & ASS2 Stecker <i>Connector green, for Aspöck ASS1 & ASS2 connector system</i>	
50 090 100	1	■	■		Rückfahrwarner für Einbau im Leuchtengehäuse <i>Back Alarm System to fit into the Rear Lamp Housing</i>	

Heckleuchte

Rear Combination Lamp



**Typ: EUROPOINT II 24V Version SCHMITZ
ASS1 & ASS2 Kompaktstecker**

Funktion: Blink-, Stop-, Rück-, Nebelschluß-, Rückfahr-, Umriß-,
Kennzeichen-, Seitenmarkierungsleuchte,
Dreieckrückstrahler, Opt. LED Modul

Function: Dir.Indicator-, Stop-, Rear-, Fog-, Reverse-, End Outline
Marker-, Numberplate-, Sidemarker Lamp,
Triangle Reflex Reflector, Opt. LED Module

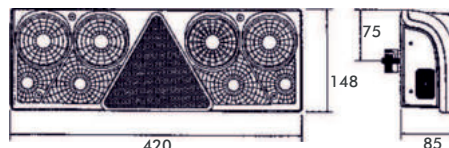

Artikel-Nr. Reference-No.	VE QTY	links left	rechts right	Kennz.- leuchte Numberplate- lamp	Beschreibung - Hersteller Referenz Specification - O.E.-No.	Anschlußsystem - Zubehör - Ersatzteile Connector - Accessories - Spare Parts
40 255 611	1	■			Aspöck 25-6000-707 ASS1 / ASS2 Kompaktstecker inkl. Glühlampen + LED Modul ASS1 / ASS2 Connector incl. bulbs + LED Module	
40 255 612	1		■		Aspöck 25-6400-707 ASS1 / ASS2 Kompaktstecker inkl. Glühlampen + LED Modul ASS1 / ASS2 Connector incl. bulbs + LED Module	
40 255 511	1	■			Aspöck 25-6010-507 ASS2 Kompaktstecker inkl. Glühlampen + LED Modul ASS2 Connector incl. bulbs + LED Module	
40 255 512	1		■		Aspöck 25-6410-507 ASS2 Kompaktstecker inkl. Glühlampen + LED Modul ASS2 Connector incl. bulbs + LED Module	
40 255 521	1	■			Aspöck 25-6200-507 ASS1 / ASS2 Kompaktstecker mit SML, inkl. Glühlampen ASS1 / ASS2 Connector with SML, incl. bulbs	
40 255 522	1		■		Aspöck 25-6600-507 ASS1 / ASS2 Kompaktstecker mit SML, inkl. Glühlampen ASS1 / ASS2 Connector with SML, incl. bulbs	
40 255 112	2	■	■		Aspöck 18-8560-002 Lichtscheibe Lens	

Heckleuchte

Rear Combination Lamp



Typ: EUROPOINT II 24V Version SCHMITZ AMP Kompaktstecker

Funktion: Blink-, Stop-, Rück-, Nebelschluß-, Rückfahr-, Umriß-,
Kennzeichen-, Dreieckrückstrahler, Opt. LED Modul

Function: Dir.Indicator-, Stop-, Rear-, Fog-, Reverse-, End Outline
Marker-, Numberplate-, Triangle Reflex Reflector,
Opt. LED Module

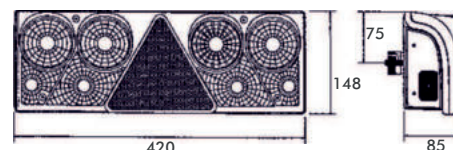

Artikel-Nr. Reference-No.	VE QTY	links left	rechts right	Kennz.- leuchte Numberplate- lamp	Beschreibung - Hersteller Referenz Specification - O.E.-No.	Anschlußsystem - Zubehör - Ersatzteile Connector - Accessories - Spare Parts
40 255 411	1	■			Aspöck Schmitz 25-6030-507 1157244 AMP Kompaktstecker inkl. Glühlampen + LED Modul AMP Connector incl. bulbs + LED Module	
40 255 412	1		■		Aspöck Schmitz 25-6430-507 1157245 AMP Kompaktstecker inkl. Glühlampen + LED Modul AMP Connector incl. bulbs + LED Module	
50 071 100	1	■	■		Reparaturset AMP 7-polig Repairkit AMP 7-poles	
50 079 200	1	■	■		Reparaturset AMP 2-polig Repairkit AMP 2-poles	
50 047 001	1	■			Aspöck 13-5626-941 Anschlußstecker gelb, passend für Aspöck ASS1 & ASS2 Stecker Connector yellow, for Aspöck ASS1 & ASS2 connector system	
50 047 002	1		■		Aspöck 13-5626-951 Anschlußstecker grün, passend für Aspöck ASS1 & ASS2 Stecker Connector green, for Aspöck ASS1 & ASS2 connector system	
50 047 003	1	■	■		Aspöck 13-5626-284 Reparaturset 2-polig, passend für Aspöck ASS1 Stecker Repairkit 2-poles, for Aspöck ASS1 connector system	
50 090 100	1	■	■		Rückfahrwarner für Einbau im Leuchtengehäuse Back Alarm System to fit into the Rear Lamp Housing	

LED Module Heckleuchte

LED Modules Rear Combination Lamp



Typ: LED Module für Heckleuchte EUROPOINT II

Funktion: LED Blink-, LED Stop-, LED Rück-, LED Nebelschluß-,
LED Rückfahrleuchte



Function: LED Dir.Indicator-, LED Stop-, LED Rear-, LED Fog-,
LED Reverse Lamp



Artikel-Nr. Reference-No.	VE QTY	links left	rechts right	Kennz.- leuchte Numberplate- lamp	Beschreibung - Hersteller Referenz Specification - O.E.-No.	Anschlußsystem - Zubehör - Ersatzteile Connector - Accessories - Spare Parts
40 255 600	1	■	■		Aspöck 12-1560-001 LED-Einsatz Rücklicht LED-Unit Rear Lamp	
40 255 700	1	■	■		Aspöck 12-1560-011 LED-Einsatz Blinklicht LED-Unit Direction Indicator Lamp	
40 255 800	1	■	■		Aspöck 12-1560-041 LED-Einsatz Bremslicht LED-Unit Stop Lamp	
40 255 400	1	■	■		Aspöck 12-1560-031 LED-Einsatz Nebelschlußlicht LED-Unit Fog Lamp	
40 255 900	1	■	■		Aspöck 12-1560-021 LED-Einsatz Rückfahrlicht LED-Unit Reverse Lamp	
40 246 603	1	■	■		Aspöck 75-0300-001 LED Kontrollgerät, Aspöck ASS2 Brems-Blink-Schlusslichtfkt. LED Control Gear, Aspöck ASS2 for Stop-Tail-Dir.Indicator function	

Heckleuchte

Rear Combination Lamp



Typ: EUROPOINT 24V

Funktion: Blink-, Stop-, Rück-, Nebelschluß-, Rückfahr-, Umriß-, Kennzeichen-, Seitenmarkierungsleuchte, Dreieckrückstrahler

Function: Dir.Indicator, Stop-, Rear-, Fog-, Reverse-, End Outline Marker-, Numberplate-, Sidemarker Lamp, Triangle Reflex Reflector

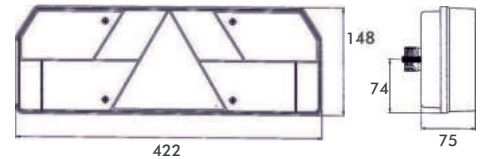

Artikel-Nr. Reference-No.	VE QTY	links left	rechts right	Kennz.- leuchte Numberplate- lamp	Beschreibung - Hersteller Referenz Specification - O.E.-No.	Anschlußsystem - Zubehör - Ersatzteile Connector - Accessories - Spare Parts
40 226 011	1	■			Aspöck 25-5100-501	
40 226 012	1		■		Aspöck 25-5500-501	
40 226 013	1	■		■	Aspöck 25-5101-501	
40 226 211	1	■			Aspöck 25-5000-511 mit Glühlampen bestückt with bulbs fitted	
40 226 212	1		■		Aspöck 25-5400-511 mit Glühlampen bestückt with bulbs fitted	
40 226 213	1	■		■	Aspöck 25-5001-511 mit Glühlampen bestückt with bulbs fitted	
40 226 112	2	■	■	■	Aspöck 18-8550-002 Lichtscheibe Lens	
50 090 100	1	■	■		Rückfahrwarner für Einbau im Leuchtengehäuse Back Alarm System to fit into the Rear Lamp Housing	

Heckleuchte

Rear Combination Lamp

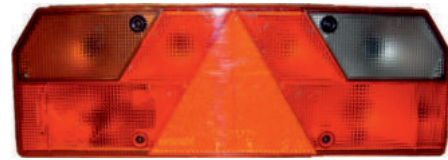



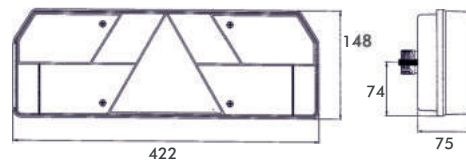

Typ: EUROPOINT 24V
Version SCHMITZ

Funktion: Blink-, Stop-, Rück-, Nebelschluß-, Rückfahr-, Umriß-,
 Dreieckrückstrahler

Function: Dir.Indicator-, Stop-, Rear-, Fog-, Reverse-, End Outline
 Marker-, Triangle Reflex Reflector



Artikel-Nr. Reference-No.	VE QTY	links left	rechts right	Kennz.- leuchte Numberplate- lamp	Beschreibung - Hersteller Referenz Specification - O.E.-No.	Anschlußsystem - Zubehör - Ersatzteile Connector - Accessories - Spare Parts
40 226 411	1	■			Aspöck 25-5010-511 mit Glühlampen bestückt <i>with bulbs fitted</i>	
40 226 412	1		■		Aspöck 25-5410-511 mit Glühlampen bestückt <i>with bulbs fitted</i>	
40 226 113	2	■	■		Aspöck 18-8550-107 Lichtscheibe Version SCHMITZ <i>Lens Version SCHMITZ</i>	
50 047 001	1	■			Aspöck 13-5626-941 Anschlußstecker gelb, passend für Aspöck ASS1 & ASS2 Stecker <i>Connector yellow, for Aspöck ASS1 & ASS2 connector system</i>	
50 047 002	1		■		Aspöck 13-5626-951 Anschlußstecker grün, passend für Aspöck ASS1 & ASS2 Stecker <i>Connector green, for Aspöck ASS1 & ASS2 connector system</i>	
50 090 100	1	■	■		Rückfahrwarner für Einbau im Leuchtengehäuse <i>Back Alarm System to fit into the Rear Lamp Housing</i>	

Heckleuchte

Rear Combination Lamp

Typ: ECOPOINT II 24V IP56K

Funktion: Blink-, Stop-, Rück-, Nebelschluß-, Rückfahr-,
Seitenmarkierungsleuchte, Dreieckrückstrahler

Function: Dir.Indicator-, Stop-, Rear-, Fog-, Reverse-,
Sidemarker Lamp, Triangle Reflex Reflector

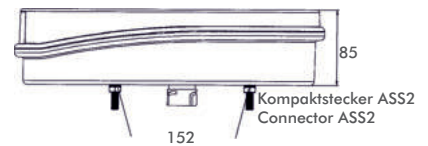
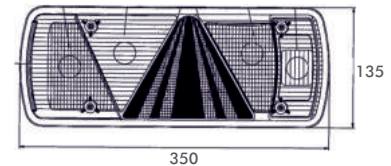

Artikel-Nr. Reference-No.	VE QTY	links left	rechts right	Kennz.- leuchte Numberplate- lamp	Beschreibung - Hersteller Referenz Specification - O.E.-No.	Anschlußsystem - Zubehör - Ersatzteile Connector - Accessories - Spare Parts
40 290 001	1	■			Aspöck 25-2800-507 ASS2 Kompaktstecker inkl. Glühlampen ASS2 Connector incl. bulbs	
40 290 002	1		■		Aspöck 25-2900-507 ASS2 Kompaktstecker inkl. Glühlampen ASS2 Connector incl. bulbs	
40 290 111	1	■			Aspöck 18-8528-002 Lichtscheibe Lens	
40 290 112	1		■		Aspöck 18-8529-002 Lichtscheibe Lens	
50 047 001	1	■			Aspöck 13-5626-941 Anschlußstecker gelb, passend für Aspöck ASS1 & ASS2 Stecker Connector yellow, for Aspöck ASS1 & ASS2 connector system	
50 047 002	1		■		Aspöck 13-5626-951 Anschlußstecker grün, passend für Aspöck ASS1 & ASS2 Stecker Connector green, for Aspöck ASS1 & ASS2 connector system	

Heckleuchte

Rear Combination Lamp

Typ: ECOPOINT II 24V IP56K

Funktion: Blink-, Stop-, Rück-, Nebelschluß-, Rückfahr-, Umriß-,
Seitenmarkierungsleuchte, Dreieckrückstrahler

Function: Dir.Indicator-, Stop-, Rear-, Fog-, Reverse-, End Outline
Marker-, Sidemarker Lamp, Triangle Reflex Reflector

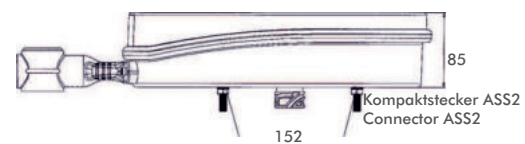
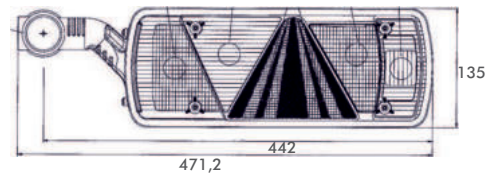

Artikel-Nr. Reference-No.	VE QTY	links left	rechts right	Kennz.- leuchte Numberplate- lamp	Beschreibung - Hersteller Referenz Specification - O.E.-No.	Anschlußsystem - Zubehör - Ersatzteile Connector - Accessories - Spare Parts
40 290 011	1	■			Aspöck 25-2810-507 ASS2 Kompaktstecker inkl. Glühlampen ASS2 Connector incl. bulbs	
40 290 012	1		■		Aspöck 25-2910-507 ASS2 Kompaktstecker inkl. Glühlampen ASS2 Connector incl. bulbs	
40 290 111	1	■			Aspöck 18-8528-002 Lichtscheibe Lens	
40 290 112	1		■		Aspöck 18-8529-002 Lichtscheibe Lens	
50 047 001	1	■			Aspöck 13-5626-941 Anschlußstecker gelb, passend für Aspöck ASS1 & ASS2 Stecker Connector yellow, for Aspöck ASS1 & ASS2 connector system	
50 047 002	1		■		Aspöck 13-5626-951 Anschlußstecker grün, passend für Aspöck ASS1 & ASS2 Stecker Connector green, for Aspöck ASS1 & ASS2 connector system	

Heckleuchte

Rear Combination Lamp



Typ: ECOPOINT 24V

Funktion: Blink-, Stop-, Rück-, Nebelschluß-, Rückfahr-,
Kennzeichenleuchte, Dreieckrückstrahler,
Opt. LED Modul

Function: Dir.Indicator-, Stop-, Rear-, Fog-, Reverse-,
Numberplate Lamp, Triangle Reflex Reflector,
Opt. LED Module

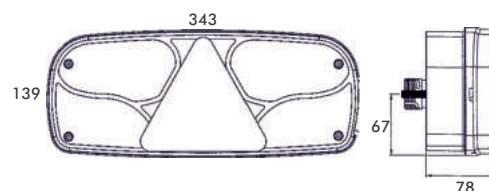

Artikel-Nr. Reference-No.	VE QTY	links left	rechts right	Kennz.- leuchte Numberplate- lamp	Beschreibung - Hersteller Referenz Specification - O.E.-No.	Anschlußsystem - Zubehör - Ersatzteile Connector - Accessories - Spare Parts
40 246 211	1	■			Aspöck 25-2200-001 mit Glühlampen bestückt with bulbs fitted	
40 246 212	1		■		Aspöck 25-2600-001 mit Glühlampen bestückt with bulbs fitted	
40 246 213	1	■		■	Aspöck 25-2201-001 mit Glühlampen bestückt with bulbs fitted	
40 246 112	2	■	■		Aspöck 18-8522-002 Lichtscheibe Lens	
50 047 001	1	■			Aspöck 13-5626-941 Anschlußstecker gelb, passend für Aspöck ASS1 & ASS2 Stecker Connector yellow, for Aspöck ASS1 & ASS2 connector system	
50 047 002	1		■		Aspöck 13-5626-951 Anschlußstecker grün, passend für Aspöck ASS1 & ASS2 Stecker Connector green, for Aspöck ASS1 & ASS2 connector system	

Heckleuchte

Rear Combination Lamp



Typ: ECOPOINT 24V

Funktion: Blink-, Stop-, Rück-, Nebelschluß-, Rückfahr-, Umriß-, Kennzeichenleuchte, Dreieckrückstrahler, Opt. LED Modul

Function: Dir.Indicator-, Stop-, Rear-, Fog-, Reverse-, End Outline Marker-, Numberplate Lamp, Triangle Reflex Reflector, Opt. LED Module

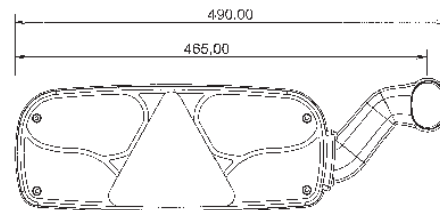

Artikel-Nr. Reference-No.	VE QTY	links left	rechts right	Kennz.- leuchte Numberplate- lamp	Beschreibung - Hersteller Referenz Specification - O.E.-No.	Anschlußsystem - Zubehör - Ersatzteile Connector - Accessories - Spare Parts
40 246 311	1	■			Aspöck 25-2210-007 mit Glühlampen bestückt with bulbs fitted	
40 246 312	1		■		Aspöck 25-2610-007 mit Glühlampen bestückt with bulbs fitted	
40 246 313	1	■		■	Aspöck 25-2211-007 mit Glühlampen bestückt with bulbs fitted	
40 246 112	2	■	■		Aspöck 18-8522-002 Lichtscheibe Lens	
50 047 001	1	■			Aspöck 13-5626-941 Anschlußstecker gelb, passend für Aspöck ASS1 & ASS2 Stecker Connector yellow, for Aspöck ASS1 & ASS2 connector system	
50 047 002	1		■		Aspöck 13-5626-951 Anschlußstecker grün, passend für Aspöck ASS1 & ASS2 Stecker Connector green, for Aspöck ASS1 & ASS2 connector system	

Heckleuchte

Rear Combination Lamp

Typ: passend für KÖGEL

Funktion: LED Schlußlicht, Blink-, Stop-, Nebelschluß-, Rückfahr-,
Umriß-, Seitenmarkierungsleuchte,
Dreieckrückstrahler

Function: LED Tail Lamp, Dir.Indicator-, Stop-, Fog-, Reverse-, End
Outline Marker-, Sidemarker Lamp,
Triangle Reflex Reflector

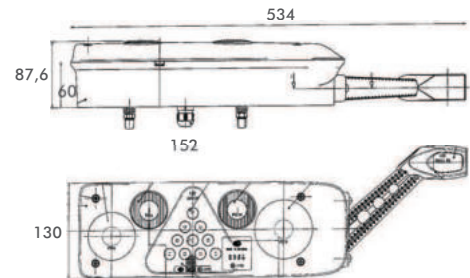

Artikel-Nr. Reference-No.	VE QTY	links left	rechts right	Kennz.- leuchte Numberplate- lamp	Beschreibung - Hersteller Referenz Specification - O.E.-No.	Anschlußsystem - Zubehör - Ersatzteile Connector - Accessories - Spare Parts
40 275 411	1	■			KÖGEL 6604332	
40 275 412	1		■		KÖGEL 6604331	
40 275 111	1	■			Lichtscheibe Lens	
40 275 112	1		■		Lichtscheibe Lens	

Heckleuchte

Rear Combination Lamp

Typ: 5-Kammerleuchte

Funktion: Blink-, Stop-, Rück-, Nebelschluß-, Rückfahr-,
Seitenmarkierungsleuchte, Dreieckrückstrahler

Function: Dir.Indicator-, Stop-, Rear-, Fog-, Reverse-,
Sidemarker Lamp, Triangle Reflex Reflector

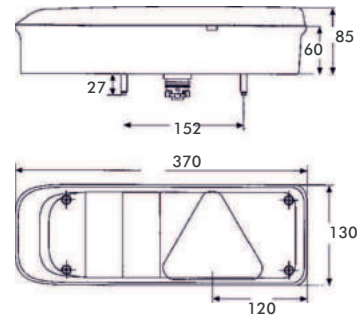

Artikel-Nr. Reference-No.	VE QTY	links left	rechts right	Kennz.- leuchte Numberplate- lamp	Beschreibung - Hersteller Referenz Specification - O.E.-No.	Anschlußsystem - Zubehör - Ersatzteile Connector - Accessories - Spare Parts
40 256 011	1	■				
40 256 012	1		■			
40 256 311	1	■				
40 256 312	1		■			
40 256 111	1	■			Lichtscheibe Lens	
40 256 112	1		■		Lichtscheibe Lens	

Heckleuchte

Rear Combination Lamp

Typ: passend für KRONE

Funktion: Blink-, Stop-, Rück-, Nebelschluß-, Rückfahr-, Umriß-,
Seitenmarkierungsleuchte, Dreieckrückstrahler

Function: Dir.Indicator-, Stop-, Rear-, Fog-, Reverse-, End Outline
Marker-, Sidemarker Lamp, Triangle Reflex Reflector

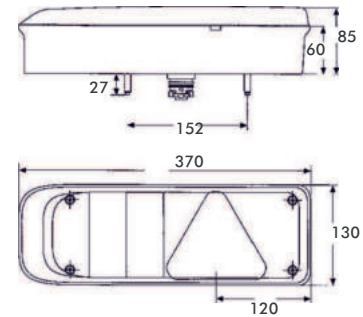

Artikel-Nr. Reference-No.	VE QTY	links left	rechts right	Kennz.- leuchte Numberplate- lamp	Beschreibung - Hersteller Referenz Specification - O.E.-No.	Anschlußsystem - Zubehör - Ersatzteile Connector - Accessories - Spare Parts
40 256 211	1	■				
40 256 212	1		■			
40 256 411	1	■				
40 256 412	1		■			
40 256 111	1	■			Lichtscheibe Lens	
40 256 112	1		■		Lichtscheibe Lens	
40 137 504	1	■			LED Umrißleuchte Kabel 0,5m + EasyCon Stecker LED End Outline Marker Lamp cable 0,5m + EasyCon Connector	
40 137 514	1		■		LED Umrißleuchte Kabel 0,5m + EasyCon Stecker LED End Outline Marker Lamp cable 0,5m + EasyCon Connector	

Heckleuchte

Rear Combination Lamp

Typ: passend für KRONE / SCHMITZ

Funktion: Blink-, Stop-, Rück-, Nebelschluß-, Rückfahr-, Umriß-,
Seitenmarkierungsleuchte, Dreieckrückstrahler

Function: Dir.Indicator-, Stop-, Rear-, Fog-, Reverse-, End Outline
Marker-, Sidemarker Lamp, Triangle Reflex Reflector

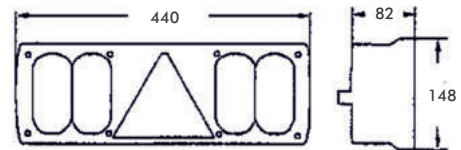

Artikel-Nr. Reference-No.	VE QTY	links left	rechts right	Kennz.- leuchte Numberplate- lamp	Beschreibung - Hersteller Referenz Specification - O.E.-No.	Anschlußsystem - Zubehör - Ersatzteile Connector - Accessories - Spare Parts
40 242 011	1	■				
40 242 012	1		■			
40 242 611	1	■				
40 242 612	1		■			
40 242 112	1	■	■		Lichtscheibe Lens	

Heckleuchte

Rear Combination Lamp

Typ: LC8T

Funktion: Blink-, Stop-, Rück-, Nebelschluß-, Rückfahr-, Umriß-,
 Seitenmarkierungsleuchte rot,
 Dreieckrückstrahler

Function: Dir.Indicator-, Stop-, Rear-, Fog-, Reverse-, End Outline
 Marker-, Sidemarker Lamp red,
 Triangle Reflex Reflector

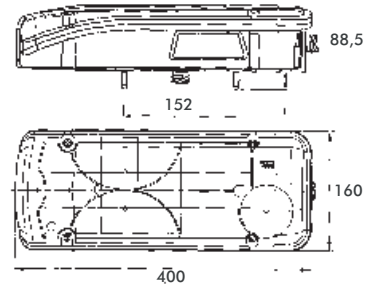

Artikel-Nr. Reference-No.	VE QTY	links left	rechts right	Kennz.- leuchte Numberplate- lamp	Beschreibung - Hersteller Referenz Specification - O.E.-No.	Anschlußsystem - Zubehör - Ersatzteile Connector - Accessories - Spare Parts
40 253 211	1	■				
40 253 212	1		■			
40 253 121	1	■			Lichtscheibe Lens	
40 253 122	1		■		Lichtscheibe Lens	
50 071 100	1	■	■		Reparaturset Repairkit	
50 120 000	2	■	■		Anschlußleitung mit AMP Stecker, 4m Cablekit with AMP connector, 4m	

Heckleuchte



Rear Combination Lamp

Typ: 7-Kammerleuchte

Funktion: Blink-, Stop-, Rück-, Nebelschluß-, Rückfahr-, Umriß-,
Seitenmarkierungsleuchte, Dreieckrückstrahler

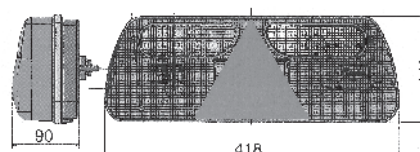
Function: Dir.Indicator-, Stop-, Rear-, Fog-, Reverse-, End Outline
Marker-, Sidemarker Lamp, Triangle Reflex Reflector



Artikel-Nr. Reference-No.	VE QTY	links left	rechts right	Kennz.- leuchte Numberplate- lamp	Beschreibung - Hersteller Referenz Specification - O.E.-No.	Anschlußsystem - Zubehör - Ersatzteile Connector - Accessories - Spare Parts
40 245 011	1	■				
40 245 012	1		■			
40 245 111	1	■			Lichtscheibe Lens	
40 245 112	1		■		Lichtscheibe Lens	

LED Heckleuchte

LED Rear Combination Lamp

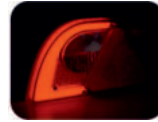
Typ: PRO-MINI-CURVE 12/24V Hybrid

Funktion: LED Schlusslicht - LED Bremslicht - Blinklicht -
 Rückfahrleuchte - Nebelschlussleuchte -
 Dreieckrückstrahler
 ohne Glühlampen

Function: LED Tail Lamp - LED Stop Lamp - Dir. Indicator Lamp -
 Reversing Lamp - Fog Lamp - Triangle Reflex Reflector
 without bulbs

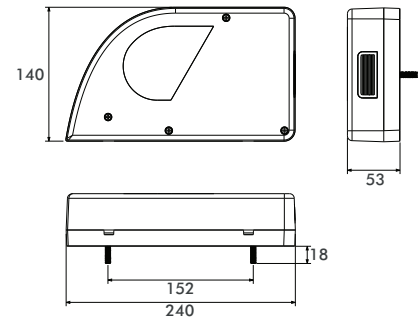

Artikel-Nr. Reference-No.	VE QTY	links left	rechts right	Kennz.- leuchte Numberplate- lamp	Beschreibung - Hersteller Referenz Specification - O.E.-No.	Anschlußsystem - Zubehör - Ersatzteile Connector - Accessories - Spare Parts
40 295 001	1	■		■ seitlich/ lateral	LED Schlusslicht in Lichtleitertechnik Ausführung Gummitülle LED Tail Lamp in Light guide technology version grommet	
40 295 002	1		■	■ seitlich/ lateral	LED Schlusslicht in Lichtleitertechnik Ausführung Gummitülle LED Tail Lamp in Light guide technology version grommet	
40 295 111	1	■			Lichtscheibe Lens	
40 295 112	1		■		Lichtscheibe Lens	
50 139 012 12V	1				LED Kontrollgerät kontrolliert die 21W Funktionen, Lastwiderstand	siehe Seite 9.3 PRO-LOAD
50 139 024 24V	1	■	■		LED Control Gear monitors the 21W functions	 see page 9.3
50 125 012 12V	1	■	■		LED Kontrollgerät Schlusslichtfunktion Lastwiderstand	siehe Seite 9.3
50 125 000 24V	1	■	■		LED Control Gear Tail Light function	 see page 9.3

Heckleuchte

Rear Combination Lamp

Typ: LED MULTIPOINT

Funktion: LED Schlusslicht, LED Bremslicht, Blink-, Nebelschluß-, Rückfahrleuchte, Dreieckrückstrahler

Function: LED Rear Lamp, LED Stop Lamp, Dir.Indicator-, Fog-, Reverse Lamp, Triangle Reflex Reflector

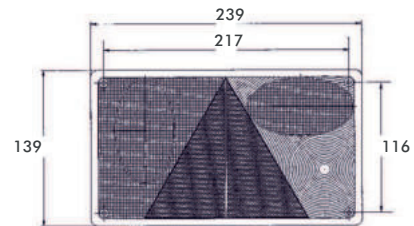

Artikel-Nr. Reference-No.	VE QTY	links left	rechts right	Kennz.- leuchte Numberplate- lamp	Nebels- leuchte Fog- lamp	Rückfahr- leuchte Reversing lamp	Beschreibung - Hersteller Referenz Specification - O.E.-No.	Anschlußsys. - Ersatzteile Connector - Spare Parts
40 233 411	1	■			■		Aspöck 34-5703-007 Anschlußleitung 1,8m Cable 1,8m	
40 233 413	1		■			■	Aspöck 34-5802-007 Anschlußleitung 1,8m Cable 1,8m	
40 233 121	1	■			■		Lichtscheibe Lens	
40 233 123	1		■			■	Lichtscheibe Lens	
12 152 700	1	■	■				LED Modul für Brems-Schlußlicht LED Module for Stop-Rear Lamp	

Heckleuchte

Rear Combination Lamp

Typ: 5-Kammerleuchte

Funktion: Blink-, Stop-, Rück-, Nebelschluß-, Rückfahr-, Dreieckrückstrahler

Function: Dir.Indicator-, Stop-, Rear-, Fog-, Reverse Lamp, Triangle Reflex Reflector

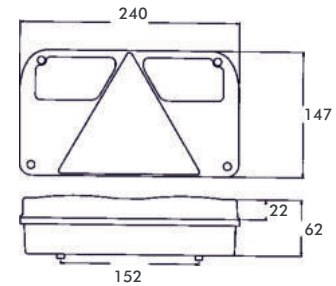

Artikel-Nr. Reference-No.	VE QTY	links left	rechts right	Kennz.- leuchte Numberplate- lamp	Nebels- leuchte Fog- lamp	Rückfahr- leuchte Reversing lamp	Beschreibung - Hersteller Referenz Specification - O.E.-No.	Anschlußsys. - Ersatzteile Connector - Spare Parts
40 268 011	1	■			■	■	Leuchte komplett aus bruchfestem Polycarbonat <i>Complete lamp made of unbreakable Polycarbonate</i>	
40 268 012	1		■		■	■	Leuchte komplett aus bruchfestem Polycarbonat <i>Complete lamp made of unbreakable Polycarbonate</i>	
40 268 111	1	■			■	■	Lichtscheibe <i>Lens</i>	
40 268 112	1		■		■	■	Lichtscheibe <i>Lens</i>	

Heckleuchte

Rear Combination Lamp

Typ: MULTIPOINT V

Funktion: Blink-, Stop-, Rück-, Nebelschluß-, Rückfahr-, Kennzeichenleuchte, Dreieckrückstrahler

Function: Dir.Indicator-, Stop-, Rear-, Fog-, Reverse-, Numberplate Lamp, Triangle Reflex Reflector

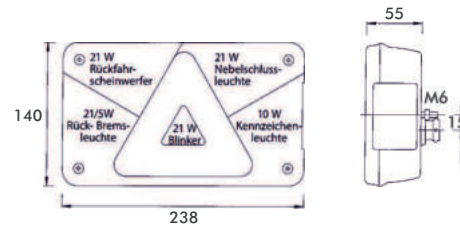

Artikel-Nr. Reference-No.	VE QTY	links left	rechts right	Kennz.- leuchte Numberplate- lamp	Nebels- leuchte Fog- lamp	Rückfahr- leuchte Reversing lamp	Beschreibung - Hersteller Referenz Specification - O.E.-No.	Anschlußsys. - Ersatzteile Connector - Spare Parts
40 227 011	1	■		■ seitlich/ lateral	■		Aspöck 24-8500-007 mit Glühlampen 12V bestückt Bulbs 12V fitted	
40 227 012	1		■	■ seitlich/ lateral			Aspöck 24-8700-007 mit Glühlampen 12V bestückt Bulbs 12V fitted	
40 227 013	1		■	■ seitlich/ lateral		■	Aspöck 24-8710-007 mit Glühlampen 12V bestückt Bulbs 12V fitted	
40 227 111	1	■					Aspöck 18-8485-007 Lichtscheibe Lens	
40 227 112	1		■				Aspöck 18-8487-007 Lichtscheibe Lens	
50 047 000	1	■	■				Reparaturkit Repairkit	

Heckleuchte

Rear Combination Lamp



Typ: MULTIPOINT II

Funktion: Blink-, Stop-, Rück-, Nebelschluß-, Rückfahr-, Kennzeichenleuchte, Dreieckrückstrahler

Function: Dir.Indicator, Stop-, Rear-, Fog-, Reverse-, Numberplate Lamp, Triangle Reflex Reflector

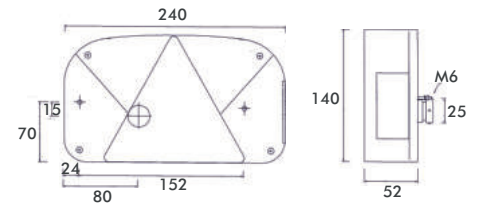

Artikel-Nr. Reference-No.	VE QTY	links left	rechts right	Kennz.- leuchte Numberplate- lamp	Nebels- leuchte Fog- lamp	Rückfahr- leuchte Reversing lamp	Beschreibung - Hersteller Referenz Specification - O.E.-No.	Anschlußsys. - Ersatzteile Connector - Spare Parts
40 248 011	1	■		■ seitlich/ lateral	■		Aspöck 24-7000-007 mit Glühlampen 12V bestückt Bulbs 12V fitted	
40 248 012	1		■	■ seitlich/ lateral			Aspöck 24-7200-007 mit Glühlampen 12V bestückt Bulbs 12V fitted	
40 248 013	1		■	■ seitlich/ lateral		■	Aspöck 24-7210-007 mit Glühlampen 12V bestückt Bulbs 12V fitted	
40 248 112	1	■	■				Aspöck 18-8470-007 Lichtscheibe Lens	
50 047 000	1	■	■				Reparaturkit Repairkit	

Heckleuchte

Rear Combination Lamp

Typ: MULTIPOINT I

Funktion: Blink-, Stop-, Rück-, Nebelschluß-, Rückfahr-,
Kennzeichenleuchte, Dreieckrückstrahler

Function: Dir.Indicator-, Stop-, Rear-, Fog-, Reverse-,
Numberplate Lamp, Triangle Reflex Reflector

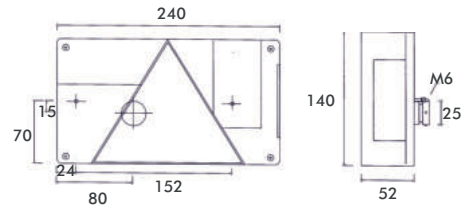
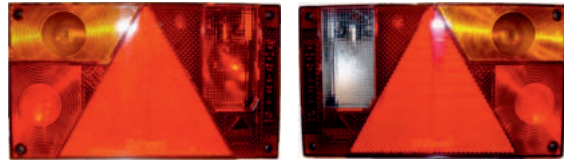

Artikel-Nr. Reference-No.	VE QTY	links left	rechts right	Kennz.- leuchte Numberplate- lamp	Nebels- leuchte Fog- lamp	Rückfahr- leuchte Reversing lamp	Beschreibung - Hersteller Referenz Specification - O.E.-No.	Anschlußsys. - Ersatzteile Connector - Spare Parts
40 224 011	1	■		■ seitlich/ lateral	■		Aspöck 24-5000-007 mit Glühlampen 12V bestückt Bulbs 12V fitted	
40 224 012	1		■	■ seitlich/ lateral			Aspöck 24-5200-007 mit Glühlampen 12V bestückt Bulbs 12V fitted	
40 224 013	1		■	■ seitlich/ lateral		■	Aspöck 24-5210-007 mit Glühlampen 12V bestückt Bulbs 12V fitted	
40 224 111	1	■			■		Aspöck 18-8450-007 Lichtscheibe Lens	
40 224 112	1		■				Aspöck 18-8452-007 Lichtscheibe Lens	
40 224 113	1		■			■	Aspöck 18-8452-107 Lichtscheibe Lens	
50 047 000	1	■	■				Reparaturkit Repairkit	

Heckleuchte

Rear Combination Lamp

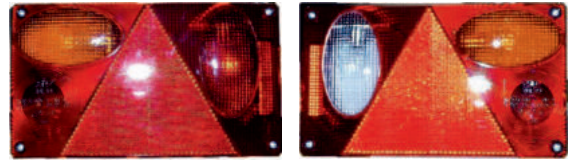

Typ: 3-Kammerleuchte

Funktion: Blink-, Stop-, Rück-, Nebelschluß-, Rückfahr-, Kennzeichenleuchte, Dreieckrückstrahler

Function: Dir.Indicator, Stop-, Rear-, Fog-, Reverse-, Numberplate Lamp, Triangle Reflex Reflector

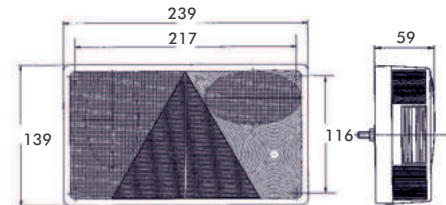

Artikel-Nr. Reference-No.	VE QTY	links left	rechts right	Kennz.- leuchte Numberplate- lamp	Nebels- leuchte Fog- lamp	Rückfahr- leuchte Reversing lamp	Beschreibung - Hersteller Referenz Specification - O.E.-No.	Anschlußsys. - Ersatzteile Connector - Spare Parts
40 233 011	1	■		■ seitlich/ lateral	■			
40 233 012	1		■	■ seitlich/ lateral				
40 233 013	1		■	■ seitlich/ lateral		■		
40 233 311	1	■		■ seitlich/ lateral	■		mit Glühlampen 12V bestückt Bulbs 12V fitted	
40 233 312	1		■	■ seitlich/ lateral			mit Glühlampen 12V bestückt Bulbs 12V fitted	
40 233 313	1		■	■ seitlich/ lateral		■	mit Glühlampen 12V bestückt Bulbs 12V fitted	
40 233 111	1	■			■		Lichtscheibe Lens	
40 233 112	1		■				Lichtscheibe Lens	
40 233 113	1		■			■	Lichtscheibe Lens	
50 047 000	1	■	■				Reparaturkit Repairkit	

Heckleuchte

Rear Combination Lamp

Typ: EARPOINT

Funktion: Blink-, Stop-, Rück-, Nebelschluß-, Rückfahrleuchte, Dreieckrückstrahler

Function: Dir.Indicator-, Stop-, Rear-, Fog-, Reverse Lamp, Triangle Reflex Reflector

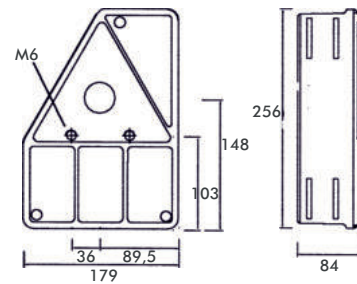

Artikel-Nr. Reference-No.	VE QTY	links left	rechts right	Kennz.- leuchte Numberplate- lamp	Nebels- leuchte Fog- lamp	Rückfahr- leuchte Reversing lamp	Beschreibung - Hersteller Referenz Specification - O.E.-No.	Anschlußsys. - Ersatzteile Connector - Spare Parts
40 247 011	1	■			■		Aspöck 24-4001-007 mit Glühlampen 12V bestückt Bulbs 12V fitted	
40 247 012	1		■				Aspöck 24-4201-007 mit Glühlampen 12V bestückt Bulbs 12V fitted	
40 247 013	1		■			■	Aspöck 24-4205-007 mit Glühlampen 12V bestückt Bulbs 12V fitted	
40 247 111	1	■			■		Aspöck 18-8440-007 Lichtscheibe Lens	
40 247 112	1		■				Aspöck 18-8442-007 Lichtscheibe Lens	
40 247 113	1		■			■	Aspöck 18-8442-107 Lichtscheibe Lens	
50 047 000	1	■	■				Reparaturkit Repairkit	

Heckleuchte

Rear Combination Lamp

Typ: EARPOINT

Funktion: Blink-, Stop-, Rück-, Nebelschluß-, Rückfahr-,
Umrißleuchte, Dreieckrückstrahler

Function: Dir.Indicator-, Stop-, Rear-, Fog-, Reverse-, End Outline
Marker Lamp, Triangle Reflex Reflector

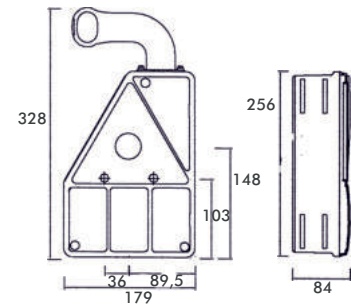

Artikel-Nr. Reference-No.	VE QTY	links left	rechts right	Kennz.- leuchte Numberplate- lamp	Nebels- leuchte Fog- lamp	Rückfahr- leuchte Reversing lamp	Beschreibung - Hersteller Referenz Specification - O.E.-No.	Anschlußsys. - Ersatzteile Connector - Spare Parts
40 247 311	1	■			■		Aspöck 24-4051-007 mit Glühlampen 12V bestückt Bulbs 12V fitted	
40 247 312	1		■				Aspöck 24-4251-007 mit Glühlampen 12V bestückt Bulbs 12V fitted	
40 247 313	1		■			■	Aspöck 24-4255-007 mit Glühlampen 12V bestückt Bulbs 12V fitted	
40 247 111	1	■			■		Aspöck 18-8440-007 Lichtscheibe Lens	
40 247 112	1		■				Aspöck 18-8442-007 Lichtscheibe Lens	
40 247 113	1		■			■	Aspöck 18-8442-107 Lichtscheibe Lens	
50 047 000	1	■	■				Reparaturkit Repairkit	

LED Leuchte

LED Lamp

Typ: PRO-CAN XL









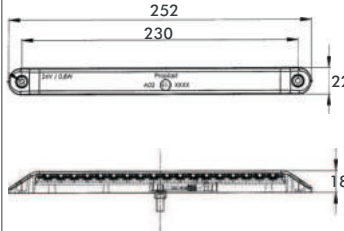

Artikel-Nr. Reference-No.	VE QTY	Beschreibung Description	LED Leuchten LED Lamps	LED Technik LED Technology
40 026 501 24V	2	LED Blinkleuchte PRO-CAN XL , Kat. 2a, Kabel 0,5m, wasserdichtes, vergossenes Leuchtgehäuse, Anbau horizontal o. vertikal <i>LED Dir. Indicator Lamp PRO-CAN XL, cat. 2a, incl. cable 0,5m, potted version, for horizontal or vertical fixation</i>	 18 LEDs	
40 026 521 12V	2	LED Blinkleuchte PRO-CAN XL , Kat. 2a, Kabel 0,5m, wasserdichtes, vergossenes Leuchtgehäuse, Anbau horizontal o. vertikal <i>LED Dir. Indicator Lamp PRO-CAN XL, cat. 2a, incl. cable 0,5m, potted version, for horizontal or vertical fixation</i>	 18 LEDs	
40 026 032 24V	2	LED Brems-Schlußleuchte PRO-CAN XL rot, Kabel 0,5m, wasserdichtes, vergossenes Leuchtgehäuse, Anbau horizontal o. vertikal <i>LED Stop-Tail Lamp PRO-CAN XL red, incl. cable 0,5m, potted version, for horizontal or vertical fixation</i>	 18 LEDs	
40 026 232 12V	2	LED Brems-Schlußleuchte PRO-CAN XL rot, Kabel 0,5m, wasserdichtes, vergossenes Leuchtgehäuse, Anbau horizontal o. vertikal <i>LED Stop-Tail Lamp PRO-CAN XL red, incl. cable 0,5m, potted version, for horizontal or vertical fixation</i>	 18 LEDs	
40 026 002 24V	2	LED Schlußleuchte PRO-CAN XL rot, Kabel 0,5m, wasserdichtes, vergossenes Leuchtgehäuse, Anbau horizontal o. vertikal <i>LED Tail Lamp PRO-CAN XL red, incl. cable 0,5m, potted version, for horizontal or vertical fixation</i>	 18 LEDs	
40 026 202 12V	2	LED Schlußleuchte PRO-CAN XL rot, Kabel 0,5m, wasserdichtes, vergossenes Leuchtgehäuse, Anbau horizontal o. vertikal <i>LED Tail Lamp PRO-CAN XL red, incl. cable 0,5m, potted version, for horizontal or vertical fixation</i>	 18 LEDs	
40 026 012 24V	2	LED Bremsleuchte PRO-CAN XL rot, Kabel 0,5m, wasserdichtes, vergossenes Leuchtgehäuse, Anbau horizontal o. vertikal <i>LED Stop Lamp PRO-CAN XL red, incl. cable 0,5m, potted version, for horizontal or vertical fixation</i>	 18 LEDs	
40 026 212 12V	2	LED Bremsleuchte PRO-CAN XL rot, Kabel 0,5m, wasserdichtes, vergossenes Leuchtgehäuse, Anbau horizontal o. vertikal <i>LED Stop Lamp PRO-CAN XL red, incl. cable 0,5m, potted version, for horizontal or vertical fixation</i>	 18 LEDs	
40 026 503 24V	2	LED Rückfahrleuchte PRO-CAN XL weiß, Kabel 0,5m, wasserdichtes, vergossenes Leuchtgehäuse, Anbau horizontal o. vertikal <i>LED Reversing Lamp PRO-CAN XL white, incl. cable 0,5m, potted version, for horizontal or vertical fixation</i>	 18 LEDs	
40 026 523 12V	2	LED Rückfahrleuchte PRO-CAN XL weiß, Kabel 0,5m, wasserdichtes, vergossenes Leuchtgehäuse, Anbau horizontal o. vertikal <i>LED Reversing Lamp PRO-CAN XL white, incl. cable 0,5m, potted version, for horizontal or vertical fixation</i>	 18 LEDs	
40 026 022 24V	2	LED Nebelschlußleuchte PRO-CAN XL rot, Kabel 0,5m, wasserdichtes, vergossenes Leuchtgehäuse, Anbau horizontal o. vertikal <i>LED Fog Lamp PRO-CAN XL red, incl. cable 0,5m, potted version, for horizontal or vertical fixation</i>	 18 LEDs	
40 026 222 12V	2	LED Nebelschlußleuchte PRO-CAN XL rot, Kabel 0,5m, wasserdichtes, vergossenes Leuchtgehäuse, Anbau horizontal o. vertikal <i>LED Fog Lamp PRO-CAN XL red, incl. cable 0,5m, potted version, for horizontal or vertical fixation</i>	 18 LEDs	

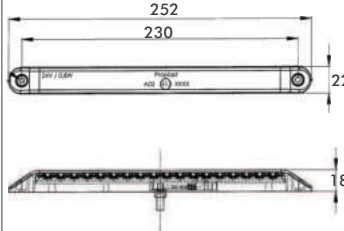
LED Leuchte

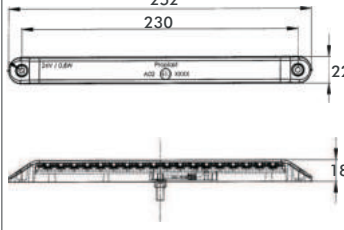
LED Lamp

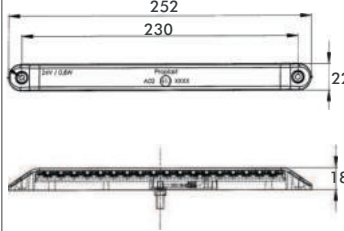
Typ: **PRO-CAN XL Klarglasoptik**



Artikel-Nr. Reference-No.	VE QTY	Beschreibung Description	LED Leuchten LED Lamps	LED Technik LED Technology
40 026 601 24V	2	LED Blinkleuchte PRO-CAN XL , Kat. 2a, Gehäuse glasklar, Kabel 0,5m, wasserdichtes, vergossenes Leuchtengehäuse, Anbau horizontal o. vertikal <i>LED Dir. Indicator Lamp</i>	 18 LEDs	
40 026 621 12V	2	PRO-CAN XL , cat. 2a, clear lens, incl. cable 0,5m, potted version, for horizontal or vertical fixation		
40 026 432 24V	2	LED Brems-Schlußleuchte PRO-CAN XL rot, Gehäuse glasklar, Kabel 0,5m, wasserdichtes, vergossenes Leuchtengehäuse, Anbau horizontal o. vertikal <i>LED Stop-Tail Lamp</i>	 18 LEDs	
40 026 332 12V	2	PRO-CAN XL red, clear lens, incl. cable 0,5m, potted version, for horizontal or vertical fixation		
40 026 422 24V	2	LED Nebelschlußleuchte PRO-CAN XL rot, Gehäuse glasklar, Kabel 0,5m, wasserdichtes, vergossenes Leuchtengehäuse, Anbau horizontal o. vertikal <i>LED Fog Lamp</i>	 18 LEDs	
40 026 322 12V	2	PRO-CAN XL red, clear lens, incl. cable 0,5m, potted version, for horizontal or vertical fixation		
40 026 503 24V	2	LED Rückfahrleuchte PRO-CAN XL weiß, Kabel 0,5m, wasserdichtes, vergossenes Leuchtengehäuse, Anbau horizontal o. vertikal <i>LED Reversing Lamp</i>	 18 LEDs	
40 026 523 12V	2	PRO-CAN XL white, incl. cable 0,5m, potted version, for horizontal or vertical fixation		
50 141 012 12V	1	LED Kontrollgerät PRO-CONTROL überwacht die Blinklichtfunktion Blinkerausfallkontrolle		LED Kontrollgerät siehe auch Katalogseite 9.13.
50 141 024 24V	1	LED Control Gear PRO-CONTROL monitors the Direction Indicator function		LED Control Gear see also catalogue page 9.13.
50 141 012 12V	1	LED Kontrollgerät überwacht die Schlußlichtfunktion		LED Kontrollgerät siehe auch Katalogseite 9.14.
50 141 024 24V	1	LED Control Gear monitors the Tail Light function		LED Control Gear see also catalogue page 9.14.

LED Leuchte

LED Lamp

Typ: PRO-MINI-RING
Aufbauversion / Pendant version



Artikel-Nr. Reference-No.	VE QTY	Beschreibung Description	LED Leuchten LED Lamps	LED Technik LED Technology
40 054 032	1	<p>LED Brems-/Schlussleuchte PRO-MINI-RING Schlusslicht in Lichtleitertechnik Kabel 0,5m, 12/24V, ADR-gepr.</p> <p><i>LED Stop-/Tail Lamp PRO-MINI-RING, tail light in light guide technology, cable 0,5m, 12/24V, ADR appr.</i></p>		
40 054 001	1	<p>LED Blinkleuchte PRO-MINI-RING, Kat. 2a, Kabel 0,5m, 12/24V, ADR-gepr.</p> <p><i>LED Dir. Indicator Lamp PRO-MINI-RING, cat. 2a, cable 0,5m, 12/24V, ADR appr.</i></p>		
40 054 022	1	<p>LED Nebelschlußleuchte PRO-MINI-RING, Kabel 0,5m, 12/24V, ADR-gepr.</p> <p><i>LED Fog Lamp PRO-MINI-RING, cable 0,5m, 12/24V, ADR appr.</i></p>		
40 054 003	1	<p>LED Rückfahrleuchte PRO-MINI-RING, Kabel 0,5m, 12/24V, ADR-gepr.</p> <p><i>LED Reversing Lamp PRO-MINI-RING, cable 0,5m, 12/24V, ADR appr.</i></p>		
50 140 012 12V	1	<p>Zentral LED Kontrollgerät PRO-LCG überwacht die Blinklichtfunktion und kontrolliert die Brems-Schluss- Nebelschluss-Rückfahrlichtfunktion, ADR, 1 LCG pro Fahrzeug</p> <p><i>Central LED Control Gear PRO-LCG monitors the direction indicator function and is checking the funtions stop-tail-fog-reverse light, ADR, 1 LCG per vehicle</i></p>		<p>LED Kontrollgerät siehe auch Katalogseite 9.13.</p> <p><i>LED Control Gear see also catalogue page 9.13.</i></p>
50 140 024 24V	1	<p>Zentral LED Kontrollgerät PRO-LCG überwacht die Blinklichtfunktion und kontrolliert die Brems-Schluss- Nebelschluss-Rückfahrlichtfunktion, ADR, 1 LCG pro Fahrzeug</p> <p><i>Central LED Control Gear PRO-LCG monitors the direction indicator function and is checking the funtions stop-tail-fog-reverse light, ADR, 1 LCG per vehicle</i></p>		<p>LED Kontrollgerät siehe auch Katalogseite 9.13.</p> <p><i>LED Control Gear see also catalogue page 9.13.</i></p>
50 141 012 12V	1	<p>LED Kontrollgerät PRO-CONTROL überwacht die Blinklichtfunktion Blinkerausfallkontrolle</p> <p><i>LED Control Gear PRO-CONTROL monitors the Direction Indicator function</i></p>		<p>LED Kontrollgerät siehe auch Katalogseite 9.13.</p> <p><i>LED Control Gear see also catalogue page 9.13.</i></p>
50 141 024 24V	1	<p>LED Kontrollgerät PRO-CONTROL überwacht die Blinklichtfunktion Blinkerausfallkontrolle</p> <p><i>LED Control Gear PRO-CONTROL monitors the Direction Indicator function</i></p>		<p>LED Kontrollgerät siehe auch Katalogseite 9.13.</p> <p><i>LED Control Gear see also catalogue page 9.13.</i></p>

LED Leuchte

LED Lamp

Typ: PRO-MINI-RING
Einbauversion / Recessed version





Artikel-Nr. Reference-No.	VE QTY	Beschreibung Description	LED Leuchten LED Lamps	LED Technik LED Technology
40 054 532	1	<p>LED Brems-/Schlussleuchte PRO-MINI-RING Schlusslicht in Lichtleitertechnik, Ring aus Edelstahl, Kabel 0,5m, 12/24V, ADR-gepr.</p> <p>LED Stop-/Tail Lamp PRO-MINI-RING, tail light in light guide technology, stainless steel ring, cable 0,5m, 12/24V, ADR appr.</p>		
40 054 501	1	<p>LED Blinkleuchte PRO-MINI-RING, Kat. 2a, Ring aus Edelstahl, Kabel 0,5m, 12/24V, ADR-gepr.</p> <p>LED Dir. Indicator Lamp PRO-MINI-RING, cat. 2a, stainless steel ring, cable 0,5m, 12/24V, ADR appr.</p>		
40 054 522	1	<p>LED Nebelschlußleuchte PRO-MINI-RING, Ring aus Edelstahl, Kabel 0,5m, 12/24V, ADR-gepr.</p> <p>LED Fog Lamp PRO-MINI-RING, stainless steel ring, cable 0,5m, 12/24V, ADR appr.</p>		
40 054 503	1	<p>LED Rückfahrleuchte PRO-MINI-RING, Ring aus Edelstahl, Kabel 0,5m, 12/24V, ADR-gepr.</p> <p>LED Reversing Lamp PRO-MINI-RING, stainless steel ring, cable 0,5m, 12/24V, ADR appr.</p>		
50 139 012 12V	1	<p>LED Kontrollgerät PRO-LOAD kontrolliert die 21W Funktionen, Lastwiderstand</p>		<p>LED Kontrollgerät siehe auch Katalogseite 9.13.</p>
50 139 024 24V	1	<p>LED Control Gear PRO-LOAD monitors the 21W functions</p>		<p>LED Control Gear see also catalogue page 9.13.</p>
50 141 012 12V	1	<p>LED Kontrollgerät überwacht die Schlußlichtfunktion</p>		<p>LED Kontrollgerät siehe auch Katalogseite 9.14.</p>
50 141 024 24V	1	<p>LED Control Gear monitors the Tail Light function</p>		<p>LED Control Gear see also catalogue page 9.14.</p>

LED Leuchte

LED Lamp

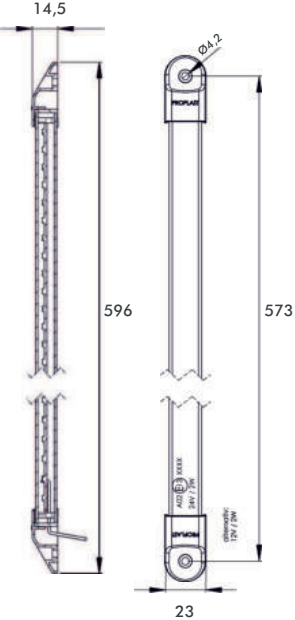
Typ: PRO-STRIPE ECE II

Artikel-Nr. Reference-No.	VE QTY	Beschreibung Description	LED Leuchten LED Lamps	LED Technik LED Technology
40 052 032 24V	1	LED Brems-Blink-Schlußleuchte PRO-STRIPE ECE II , Kabel 0,5m, wasserdichtes, vergossenes Leuchtengehäuse, Anbau horizontal o. vertikal, ADR-gepr. IP6K9K	 <p>PRO-STRIPE ECE II 596mm</p>	
40 052 232 12V	1	LED Stop-Tail-Dir. Indicator Lamp PRO-STRIPE ECE II , incl. cable 0,5m, potted version, for horizontal or vertical fixation, ADR-appr. IP6K9K		
40 052 022 24V	1	Kombinierte LED Nebelschluß-/Rückfahrleuchte PRO-STRIPE ECE II , zugelassen für horizont. und vertikale Anbaulage, ADR-gepr. IP6K9K, Kabel 0,5m		
40 052 222 12V	1	LED Fog-/Reversing Lamp PRO-STRIPE ECE II , approved for horizontal and vertical fixation, ADR-appr. IP6K9K, cable 0,5m		
40 052 042 24V	1	LED Zusatzbremsleuchte PRO-STRIPE ECE II Kabel 0,5m, wasserdichtes, vergossenes Leuchtengehäuse, 40 Hochleistungsdioden, Anbau horizontal, ADR-gepr. IP6K9K		
40 052 242 12V	1	3rd LED Stop Lamp PRO-STRIPE ECE II , cable 0,5m, 40 LED fitted in a waterproof housing, for horizontal fixation, ADR-appr. IP6K9K		
40 048 200	1	Befestigungskit PRO-STRIPE ECE inkl. Schrauben Mounting Kit PRO-STRIPE ECE incl. screws	 <p>40 48 200</p>	

LED Leuchtengarnituren

LED Lighting Kits

 Seitenansicht
 side view

 Rückansicht
 Back view

Artikel-Nr. Reference-No.	VE QTY	Beschreibung Specification
40 057 700	1	<ul style="list-style-type: none"> - Magnetischer Beleuchtungs-Anbausatz - 2 x LED Brems-Blink-Schlußleuchten 12V PRO-SQUARE 3F - integrierte Blinkerausfallkontrolle - LED Schlusslicht in Lichtleitertechnik - Lichtscheibe aus bruchfestem Polycarbonat - komplett wasserdicht - ECE R10 geprüft (EMV) - 7,0m Kabel inkl. Stecker 7-polig <ul style="list-style-type: none"> - Magnetic Lighting Kit - 2 x LED Dir.Indicator-,Stop-, Rearlamps 12V PRO-SQUARE 3F - integrated Flasher control unit - LED Tail light with light guide technology - Lens made of unbreakable Polycarbonate - waterproof casted - ECE R10 approved (EMC) - 7,0m Cable incl. Plug 7-poles

 Seitenansicht
 side view

 Rückansicht
 Back view

Artikel-Nr. Reference-No.	VE QTY	Beschreibung Specification
40 059 700	1	<ul style="list-style-type: none"> - Magnetischer Beleuchtungs-Anbausatz - 2 x LED Brems-Blink-Schlußleuchten 12V PRO-AGRILED II - integrierte Blinkerausfallkontrolle - komplett wasserdicht - 7,0m Kabel inkl. Stecker 7-polig <ul style="list-style-type: none"> - Magnetic Lighting Kit - 2 x LED Dir.Indicator-,Stop-, Rearlamps 12V PRO-AGRILED II - integrated Flasher control unit - waterproof casted - 7,0m Cable incl. Plug 7-poles

Leuchtengarnituren

Lighting Kits

 Seitenansicht
 side view

 Rückansicht
 Back view

Artikel-Nr. Reference-No.	VE QTY	Beschreibung Specification	
40 305 600	1	<ul style="list-style-type: none"> - Magnetischer Beleuchtungs-Anbausatz - 2 x Brems-Blink-Schlußleuchten 12V - 7,5m Kabel inkl. Stecker 7-polig - 2,5m Kabel zwischen den Leuchten 	<ul style="list-style-type: none"> - Magnetic Lighting Kit - 2 x Dir.Indicator-,Stop-, Rearlamps 12V - 7,5m Cable incl. Plug 7-poles - 2,5m Cable between the lights
40 305 700	1	<ul style="list-style-type: none"> - Magnetischer Beleuchtungs-Anbausatz - 2 x Brems-Blink-Schlußleuchten 12V - 10m Kabel inkl. Stecker 7-polig - 2,5m Kabel zwischen den Leuchten 	<ul style="list-style-type: none"> - Magnetic Lighting Kit - 2 x Dir.Indicator-,Stop-, Rearlamps 12V - 10m Cable incl. Plug 7-poles - 2,5m Cable between the lights



Artikel-Nr. Reference-No.	VE QTY	Beschreibung Specification	
40 305 200	1	<ul style="list-style-type: none"> - 2 x Brems-Blink-Schlußleuchten 12V - Traverse verstellbar bis 1,60m - 10m Kabel inkl. Stecker 7-polig - 2 x Dreieckrückstrahler + Kennzeichenschild - Schraub-Klemmbefestigung inkl. Installationsmaterial 	<ul style="list-style-type: none"> - 2 x Dir.Indicator-,Stop-,Rearlamps 12V - Lighting Kit adjustable up to 1,60m - 10m Cable incl. Plug 7-poles - 2 x Triangle-Reflex Reflectors + Registration Plate - Fixing Kit

LED Nebelschlußleuchten/ LED Rückfahrleuchten	LED Fog Lamps/LED Reversing Lamps	2.0	- 2.5
Nebelschlußleuchten/Rückfahrleuchten	Fog Lamps/Reversing Lamps	2.6	
LED Blinkleuchten	LED Direction Indicator Lamps	2.7	- 2.12
LED 3. Bremsleuchten	LED 3rd Stop Lamps	2.13	







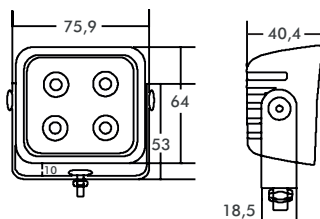

plötzLICHT

LED Nebelschluß-/Rückfahrleuchte

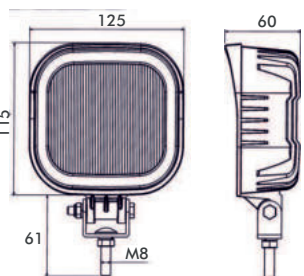
LED Fog-/Reversing Lamp

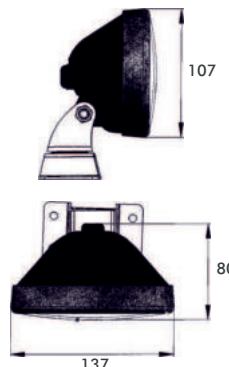
Typ: PRO-FIELD, PRO-REVERSE, PRO-REAR, PRO-FOG

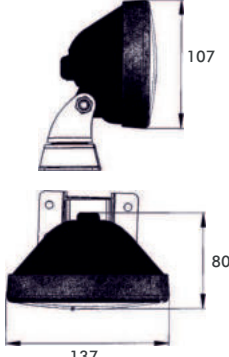
Artikel-Nr. Reference-No.	VE QTY	Beschreibung Description	LED Leuchten LED Lamps	LED Technik LED Technology
NEW 40 424 003	1	LED Rückfahrcheinwerfer PRO-FIELD , geprüft gem. ECE R23, auch als Arbeitsscheinwerfer einsetzbar, ca. 800lm, sehr homogene Ausleuchtung, 12W, Kabel 0,45m, ADR & EMV geprüft, 9-32V <i>LED Reversing-Work Lamp PRO-FIELD according to ECE R23, useable as Work Lamp, 800 lumen, homogeneous illumination, 12W, cable 0,45m, ADR & EMC appr., 9-32V</i>		
40 466 003	1	LED Rückfahrcheinwerfer PRO-REVERSE , geprüft gem. ECE R23, leistungsstarker Scheinwerfer mit Hochleistungs-LEDs, klare Streuscheibe aus bruchfestem PC, kleine kompakte Bauform, Kabel 0,5m, ADR-geprüft, 12V/24V, 8W <i>LED Reversing Lamp PRO-REVERSE according to ECE R23, clear lens made of unbreakable PC, small, solid housing, cable 0,5m, ADR-appr., 12V/24V, 8W</i>		
40 460 903	1	LED Rückfahrcheinwerfer PRO-REAR , geprüft gem. ECE R23, hohe Lichtstärke durch brillantes Freiformspiegel-Design 6 Hochleistungs-LEDs, Streuscheibe aus bruchfestem PC, U-Bügelbefestigung, kleine kompakte Bauform, Kabel 1,75m ADR-geprüft, 12V-6,2W, 24V-7,7W <i>LED Reversing Lamp PRO-REAR accord. to ECE R23, high intensity light due to brilliant free-form technology, 6 high power LEDs, Lens made of unbreakable PC, cable 1,75m, ADR-appr., 12V-6,2W, 24V-7,7W</i>		
40 460 802	1	LED Nebelschlußleuchte PRO-FOG , geprüft gem. ECE R38, hohe Lichtstärke durch brillantes Freiformspiegel-Design 6 Hochleistungs-LEDs, Streuscheibe aus bruchfestem PC, U-Bügelbefestigung, kleine kompakte Bauform, Kabel 1,75m ADR-geprüft, 12V-6,2W, 24V-7,7W <i>LED FOG Lamp PRO-FOG accord. to ECE R38, high intensity light due to brilliant free-form technology, 6 high power LEDs, Lens made of unbreakable PC, cable 1,75m, ADR-appr., 12V-6,2W, 24V-7,7W</i>		

LED Nebelschluß-/Rückfahrleuchte

LED Fog-/Reversing Lamp

Typ: PRO-SPOT ECO FR & PRO-SPOT FR

Artikel-Nr. Reference-No.	VE QTY	Beschreibung Description	LED Nebelschluß-/ Rückfahrleuchten LED Fog-/Reversing Lamps	LED Technik LED Technology
40 025 502	1	Kombinierte LED- Nebelschluß-/Rückfahrleuchte PRO-SPOT ECO FR , ADR & ECE R10, 12/24V, Kabel 0,5m <i>LED-Fog-/Reversing Lamp PRO-SPOT ECO FR, 12/24V, cable 0,5m</i>		
40 025 522	1	PRO-SPOT ECO FR , dito., Kabel 0,5m + 7-pol. Stecker <i>PRO-SPOT ECO FR, cable 0,5m + 7-pol. AMP con.</i>		
40 025 002	1	Kombinierte LED Nebelschluß-/Rückfahrleuchte PRO-SPOT FR , 10-30V, Kabeleingang PG-Verschraubung <i>LED Fog-/Reversing Lamp PRO-SPOT FR, 10-30V, with PG-screw</i>		
40 025 462	1	Kombinierte LED Nebelschluß-/Rückfahrleuchte PRO-SPOT FR , 10-30V, inkl. 2m Anschlußleitung <i>LED Fog-/Reversing Lamp PRO-SPOT FR, 10-30V, incl. 2m cable</i>		
40 019 102	1	Einbau-Kit Chrom für LED Nebelschluß-/Rückfahr- leuchte PRO-SPOT FR <i>Built-In Kit chrome for LED fog-/ reversing lamp PRO-SPOT FR</i>		
20 105 004	1	Dreieckrückstrahler PRO-REFLEX <i>Triangle Reflex Reflector PRO-REFLEX</i>		
			40 019 102	20 105 004

LED Nebelschluß-/Rückfahrleuchte

LED Fog-/Reversing Lamp



Artikel-Nr. Reference-No.	VE QTY	Beschreibung Description	LED Nebelschluß-/ Rückfahrleuchten LED Fog-/Reversing Lamps	LED Technik LED Technology
40 053 002	1	Kombinierte LED- Nebelschluß-/Rückfahrleuchte PRO-DISC FR , ADR & ECE R10, 12/24V, Kabel 1,8m LED-Fog-/Reversing Lamp PRO-DISC FR , 12/24V, cable 1,8m		
40 053 202	1	PRO-DISC FR , dito., Kabel 0,3m + 7-pol. Stecker PRO-DISC FR , cable 0,3m + 7-pol. AMP connector		
40 051 002	1	Kombinierte LED- Nebelschluß-/Rückfahrleuchte mit LED Schussleuchte im Aussenring, PRO-RING FR , 12/24V, Kabel 0,5m LED-Fog-/Reversing Lamp incl. LED Tail lamp in the outer ring, PRO-RING FR , 12/24V, cable 0,5m		
40 278 002	1	Kombinierte LED- Nebelschluß-/Rückfahrleuchte PRO-WAY FR , 12/24V, Kabel 0,3m LED-Fog-/Reversing Lamp PRO-WAY FR , 12/24V, cable 0,3m		
40 283 002	1	Kombinierte LED- Nebelschluß-/Rückfahrleuchte PRO-TOP FR , 12/24V, ADR geprüft, Kabel 0,5m LED-Fog-/Reversing Lamp PRO-TOP FR , 12/24V, ADR approved, cable 0,5m		

LED Nebelschluß-/Rückfahrleuchte

LED Fog-/Reversing Lamp



Artikel-Nr. Reference-No.	VE QTY	Beschreibung Description	LED Nebelschluß-/ Rückfahrleuchten LED Fog-/Reversing Lamps	LED Technik LED Technology
40 288 002	1	Kombinierte LED- Nebelschluß-/Rückfahrleuchte PRO-ROAD FR , 12/24V, IP6K9K geprüft, Kabel 0,5m <i>LED-Fog-/Reversing Lamp PRO-ROAD FR, 12/24V, IP6K9K geprüft, cable 0,5m</i>		
40 057 002	1	Kombinierte LED- Nebelschluß-/Rückfahrleuchte PRO-SQUARE FR , 12/24V, IP6K9K geprüft, Kabel 0,5m <i>LED-Fog-/Reversing Lamp PRO-SQUARE FR, 12/24V, IP6K9K approved, cable 0,5m</i>		
40 057 502	1	PRO-SQUARE FR , dito., mit seitr. Kennzeichenleuchte <i>PRO-SQUARE FR, dito., with lat. Numberplate Lamp</i>		
40 057 602	1	PRO-SQUARE FR , dito., mit Kennzeichenleuchte nach unten <i>PRO-SQUARE FR, dito., with Numberplate Lamp below</i>		
40 058 002	1	Kombinierte LED- Nebelschluß-/Rückfahrleuchte PRO-OVAL FR , 12/24V, IP6K9K geprüft, Kabel 0,5m <i>LED-Fog-/Reversing Lamp PRO-OVAL FR, 12/24V, IP6K9K approved, cable 0,5m</i>		

LED Nebelschluß-/Rückfahrleuchte

LED Fog-/Reversing Lamp



Artikel-Nr. Reference-No.	VE QTY	Beschreibung Description	LED Nebelschluß-/Rückfahrleuchten LED Fog-/Reversing Lamps
40 052 022 24V	1	Kombinierte LED Nebelschluß-/Rückfahrleuchte PRO-STRIPE ECE II , zugelassen für horizont. und vertikale Anbaulage, IP6K9K geprüft, Kabel 0,5m	
40 052 222 12V	1	LED Fog-/Reversing Lamp PRO-STRIPE ECE II , approved for horizontal and vertical fixation, IP6K9K approved, cable 0,5m	
40 026 022 24V	2	LED Nebelschlußleuchte PRO-CAN XL rot, Kabel 0,5m, wasserdichtes, vergossenes Leuchtgehäuse, Anbau horizontal o. vertikal, 3W	
40 026 222 12V	2	LED Fog Lamp PRO-CAN XL , red, cable 0,5m, potted version, for horizontal or vertical fixation, 3W	
40 026 422 24V	2	LED Nebelschlußleuchte PRO-CAN XL rot, Gehäuse glasklar, Kabel 0,5m, komplett, vergossenes Leuchtgehäuse, Anbau horizontal o. vertikal, 3W	
40 026 322 12V	2	LED Fog Lamp PRO-CAN XL red, clear lens, cable 0,5m, potted version, for horizontal or vertical fixation, 3W	
40 026 503 24V	2	LED Rückfahrleuchte PRO-CAN XL weiß, Kabel 0,5m, wasserdichtes, vergossenes Leuchtgehäuse, Anbau horizontal o. vertikal, 3W	
40 026 523 12V	2	LED Reversing Lamp PRO-CAN XL white, incl.cable 0,5m, potted version, for horizontal or vertical fixation, 3W	

LED Nebelschluß-/Rückfahrleuchte









LED Fog-/Reversing Lamp

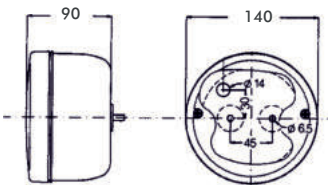

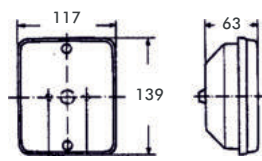
Artikel-Nr. Reference-No.	VE QTY	Beschreibung Description	LED Nebelschluß-/ Rückfahrleuchten LED Fog-/Reversing Lamps	LED Technik LED Technology
NEW 40 149 202	1	Kombinierte LED Nebelschluß-/ Rückfahrleuchte Kabel 0,5m, IP6K9K geprüft, 24V LED-Fog-/Reversing Lamp cable 0,5m, IP6K9K geprüft, 24V		
40 149 222	1	Kombinierte LED Nebelschluß-/ Rückfahrleuchte, 7-pol. AMP St. IP6K9K geprüft, 24V LED-Fog-/Reversing Lamp 7-pol. AMP, IP6K9K geprüft, 24V		
40 149 402	1	LED Nebelschlußleuchte 24V LED Fog Lamp 124V		
40 149 403	1	LED Rückfahrleuchte 24V LED Reversing Lamp 24V		
40 054 022	1	LED Nebelschlußleuchte PRO-MINI-RING, Aufbauversion, Kabel 0,5m, 12/24V, ADR-gepr. LED Fog Lamp PRO-MINI-RING, pendant version, cable 0,5m, 12/24V, ADR appr.		
40 054 522	1	LED Nebelschlußleuchte PRO-MINI-RING, Einbauversion LED Fog Lamp PRO-MINI-RING, recessed version		
40 054 003	1	LED Rückfahrleuchte PRO-MINI-RING, Aufbauversion, Kabel 0,5m, 12/24V, ADR-gepr. LED Reversing Lamp PRO-MINI-RING, pendant version, cable 0,5m, 12/24V, ADR appr.		
40 054 503	1	LED Rückfahrleuchte PRO-MINI-RING, Einbauversion LED Reversing Lamp PRO-MINI-RING, recessed version		

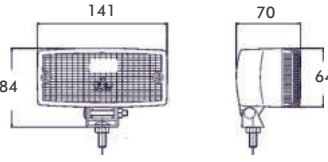
Nebelschluß-/Rückfahrleuchte

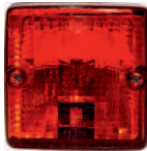
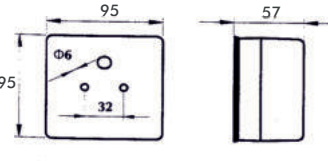
Fog-/Reversing Lamp









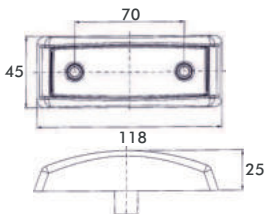

Artikel-Nr. Reference-No.	VE QTY	Beschreibung Description	Nebelschluß-/ Rückfahrleuchten Fog-/Reversing Lamps	BA 15s / P21W
40 149 002	1	Nebelschlussleuchte <i>Fog Lamp</i>		
40 149 003	1	Rückfahrleuchte <i>Reversing Lamp</i>		
40 130 002	1	Nebelschlussleuchte <i>Fog Lamp</i>		
40 130 003	1	Rückfahrleuchte <i>Reversing Lamp</i>		
40 132 002	1	Nebelschlussleuchte <i>Fog Lamp</i>		
40 132 003	1	Rückfahrleuchte <i>Reversing Lamp</i>		
40 162 002	1	Nebelschlussleuchte <i>Fog Lamp</i>		
40 162 003	1	Rückfahrleuchte <i>Reversing Lamp</i>		

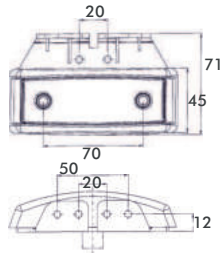
Seitliche LED Blinkleuchte

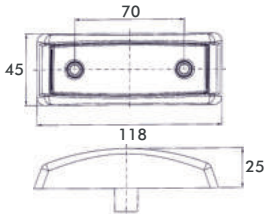
Lateral LED Direction Indicator Lamp

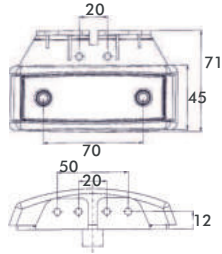
Typ: **PRO-MULTI-SML**











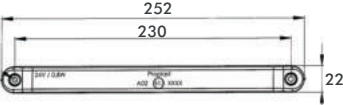

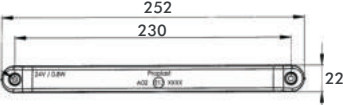

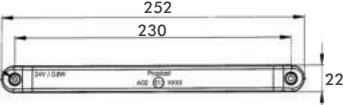
Artikel-Nr. Reference-No.	VE QTY	Beschreibung Description	LED Seitenmarkierungs-/ Blinkleuchten LED Sidemarker-/ Dir. Indicator Lamps	LED Technik LED Technology
40 049 801	2	LED Seitenmarkierungsleuchte + seitliche Blinkleuchte Kat. 5, PRO-MULTI-SML , Kabel 0,5m, 10-32V/1,6W, IP6K9K, ADR gepr. <i>LED Sidemarker Lamp incl. lateral LED Direction Indicator Lamp cat. 5, PRO-MULTI-SML, cable 0,5m, 10-32V/1,6W, IP6K9K, ADR approved</i>	 Kategorie 5 + LED SML	
40 049 821	2	LED Seitenmarkierungsleuchte + seitliche Blinkleuchte Kat. 5, PRO-MULTI-SML , Kabel 0,5m, 90° Winkelhalter, 10-32V/1,6W, IP6K9K, ADR geprüft <i>LED Sidemarker Lamp incl. lateral LED Direction Indicator Lamp cat. 5, PRO-MULTI-SML, cable 0,5m, bracket 90°, 10-32V/1,6W, IP6K9K, ADR approved</i>	 Kategorie 5 + LED SML	
40 049 501	2	LED Seitenmarkierungsleuchte + seitliche Blinkleuchte Kat. 5, PRO-MULTI-SML , 10-32V/1,6W, AMP Super Seal Stecker 3-pol., IP6K9K, ADR geprüft <i>LED Sidemarker Lamp incl. lateral LED Direction Indicator Lamp cat. 5, PRO-MULTI-SML, AMP SS con. 3-poles, 10-32V/1,6W, IP6K9K, ADR approved</i>	 Kategorie 5 + LED SML	
40 049 521	2	LED Seitenmarkierungsleuchte + seitliche Blinkleuchte Kat. 5, PRO-MULTI-SML , 10-32V/1,6W, AMP Super Seal Stecker 3-pol., 90° Winkelhalter, IP6K9K, ADR <i>LED Sidemarker Lamp incl. lateral LED Direction Indicator Lamp cat. 5, PRO-MULTI-SML, AMP SS connector 3-poles, bracket 90, 10-32V/1,6W, IP6K9K, ADR approved</i>	 Kategorie 5 + LED SML	
50 079 400	1	Steckverbinder Buchsengehäuse 3-polig, AMP SUPER SEAL für Anschluss an 40 049 501 und 40 049 521 <i>Connector 3-poles female, AMP SUPER SEAL suitable for Ref. 40 049 501 and Ref. 40 049 521</i>		
50 141 012 12V	1	LED Kontrollgerät PRO-CONTROL überwacht die Blinklichtfunktion Blinkerausfallkontrolle		LED Kontrollgerät siehe auch Katalogseite 9.9
50 141 024 24V	1	LED Control Gear PRO-CONTROL monitors the Direction Indicator function		LED Control Gear see also catalogue page 9.9

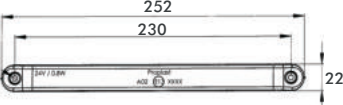
LED Blinkleuchte

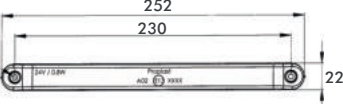
LED Direction Indicator Lamp

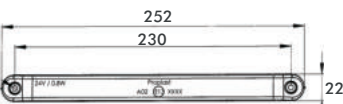
Typ: PRO-CAN XL













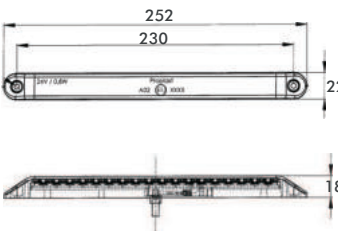



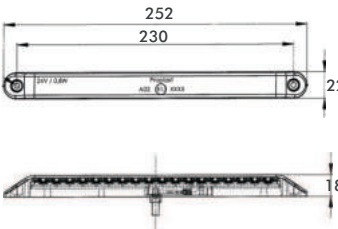

Artikel-Nr. Reference-No.	VE QTY	Beschreibung Description	LED Blinkleuchten LED Dir. Indicator Lamps	LED Technik LED Technology
40 026 011 24V	2	Vordere LED Blinkleuchte PRO-CAN XL , Kat. 1a, Kabel 0,5m, wasserdichtes, vergossenes Leuchtgehäuse, Anbau horizontal o. vertikal		
40 026 211 12V	2	Front LED Dir. Indicator Lamp PRO-CAN XL , cat. 1a incl. cable 0,5m, potted version, for horizontal or vertical fixation	Kategorie 1a 18 LEDs	
40 026 031 24V	2	Vordere LED Blinkleuchte PRO-CAN XL , Kat. 1a, Gehäuse glasklar, Kabel 0,5m, wasserdichtes, vergossenes Leuchtgehäuse, Anbau horizontal o. vertikal		
40 026 231 12V	2	Front LED Dir. Indicator Lamp PRO-CAN XL , cat. 1a, clear lens, cable 0,5m, potted version, for horizontal or vertical fixation	Kategorie 1a 18 LEDs	
40 026 501 24V	2	Hintere LED Blinkleuchte PRO-CAN XL , Kat. 2a, Kabel 0,5m, wasserdichtes, vergossenes Leuchtgehäuse, Anbau horizontal o. vertikal		
40 026 521 12V	2	Rear LED Dir. Indicator Lamp PRO-CAN XL , cat. 2a incl. cable 0,5m, potted version, for horizontal or vertical fixation	Kategorie 2a 18 LEDs	
40 026 601 24V	2	Hintere LED Blinkleuchte PRO-CAN XL , Kat. 2a, Gehäuse glasklar, Kabel 0,5m, wasserdichtes, vergossenes Leuchtgehäuse, Anbau horizontal o. vertikal		
40 026 621 12V	2	Rear LED Dir. Indicator Lamp PRO-CAN XL , cat. 2a, clear lens, cable 0,5m, potted version, for horizontal or vertical fixation	Kategorie 2a 18 LEDs	
40 026 701 24V	2	Seitliche LED Blinkleuchte PRO-CAN XL , Kat.5, Kabel 0,5m, wasserdichtes, vergossenes Leuchtgehäuse, Anbau horizontal o. vertikal		
40 026 721 12V	2	Lateral LED Dir. Indicator Lamp PRO-CAN XL , cat.5 incl. cable 0,5m, potted version, for horizontal or vertical fixation	Kategorie 5 18 LEDs	
40 026 801 24V	2	Kombinierte LED SML + Seitliche LED Blinkleuchte PRO-CAN XL , Kat.5, Kabel 0,5m, wasserdichtes, vergossenes Leuchtgehäuse, Anbau horizontal o. vertikal, 24V		
		LED SML + Lateral LED Dir. Indicator Lamp PRO-CAN XL , cat.5 incl. cable 0,5m, potted version, for horizontal or vertical fixation	Kategorie 5 + LED SML 18 LEDs	

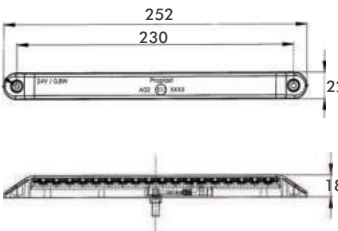
LED Blinkleuchte

LED Direction Indicator Lamp

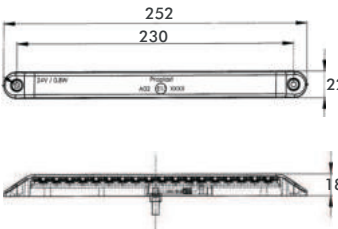
Typ: **PRO-CAN XL**
 dynamische Blinklichtfunktion



Artikel-Nr. Reference-No.	VE QTY	Beschreibung Description	LED Blinkleuchten LED Dir. Indicator Lamps	LED Technik LED Technology
40 026 061 24V 	2	Vordere LED Blinkleuchte PRO-CAN XL , dynamische Funktion, Kat. 1a, Kabel 0,5m, wasserdichtes, vergossenes Leuchtgehäuse, Anbau horizontal, ADR-gepr. IP67, ECE R10	 Kategorie 1a 18 LEDs	
40 026 261 12V	2	Front LED Dir. Indicator Lamp PRO-CAN XL , sequential turn signal, cat. 1a, cable 0,5m, potted version, for horizontal fixation, ADR-appr. IP67, ECE R10		
40 026 071 24V 	2	Vordere LED Blinkleuchte PRO-CAN XL , dynamische Funktion, Kat. 1a, Kabel 0,5m, Gehäuse glasklar, wasserdichtes, vergossenes Leuchtgehäuse, Anbau horizontal, ADR-gepr. IP67, ECE R10	 Kategorie 1a 18 LEDs	
40 026 271 12V	2	Front LED Dir. Indicator Lamp PRO-CAN XL , sequential turn signal, cat. 1a, cable 0,5m, clear lens, potted version, for horizontal fixation, ADR-appr. IP67, ECE R10		
40 026 041 24V 	2	Hintere LED Blinkleuchte PRO-CAN XL , dynamische Funktion, Kat. 2a, Kabel 0,5m, wasserdichtes, vergossenes Leuchtgehäuse, Anbau horizontal, ADR-gepr. IP67, ECE R10	 Kategorie 2a 18 LEDs	
40 026 241 12V	2	Rear LED Dir. Indicator Lamp PRO-CAN XL , sequential turn signal, cat. 2a, cable 0,5m, potted version, for horizontal fixation, ADR-appr. IP67, ECE R10		
40 026 051 24V 	2	Hintere LED Blinkleuchte PRO-CAN XL , dynamische Funktion, Kat. 2a, Kabel 0,5m, Gehäuse glasklar, wasserdichtes, vergossenes Leuchtgehäuse, Anbau horizontal, ADR-gepr. IP67, ECE R10	 Kategorie 2a 18 LEDs	
40 026 251 12V	2	Rear LED Dir. Indicator Lamp PRO-CAN XL , sequential turn signal, cat. 2a, cable 0,5m, clear lens, potted version, for horizontal fixation, ADR-appr. IP67, ECE R10		
50 141 012 12V	1	LED Kontrollgerät PRO-CONTROL überwacht die Blinklichtfunktion Blinkerausfallkontrolle		LED Kontrollgerät siehe auch Katalogseite 9.9
50 141 024 24V	1	LED Control Gear PRO-CONTROL monitors the Direction Indicator function		LED Control Gear see also catalogue page 9.9

Seitliche LED Blinkleuchte

Lateral LED Direction Indicator Lamp



Artikel-Nr. Reference-No.	VE QTY	Beschreibung Description	LED Blinkleuchten LED Dir. Indicator Lamps	LED Technik LED Technology
NEW 40 071 001	1	LED Blinkleuchte, seitliche Blinkleuchte Kat. 6, integr. Seitenmarkierungsleuchte & Rückstrahler, 3-polig AMP SuperSeal Stecker, IP67, 12/24V ECE R10 geprüft <i>LED Dir. Indicator Lamp, Cat. 6, integrated sidemarker lamp & reflex reflector, 3-pin AMP SuperSeal connector, IP67, 12/24V, ECE R10 approved</i>	 Kategorie 6	
NEW 40 069 001	1	LED Blinkleuchte, seitliche Blinkleuchte Kat. 6, integr. Seitenmarkierungsleuchte & Rückstrahler, 3-polig AMP SuperSeal Stecker, IP67, 12/24V, ECE R10 geprüft <i>LED Dir. Indicator Lamp, Cat. 6, integrated sidemarker lamp & reflex reflector, 3-pin AMP SuperSeal connector, IP67, 12/24V, ECE R10 approved</i>	 Kategorie 6	
NEW 40 067 001	1	LED Blinkleuchte PRO-WING , seitliche Blinkleuchte Kat. 6, integriertes Lichtdesign Element in Lightguide Technologie, Klarglasoptik, Lichtscheibe aus bruchfestem Polycarbonat, Kabel 0,5m, EMV geprüft, 9-33V <i>LED Dir. Indicator Lamp PRO-WING, Cat. 6, attractive design due to integrated light guide technology, clear glass optic, lens made of unbreakable polycarbonate, cable 0,5m, EMC appr., 9-33V</i>	 Kategorie 6	
NEW 40 002 901	1	Seitliche LED Blinkleuchte PRO-PENNY , Kat. 5, Kabel 0,5m, 12/24V, ADR-gepr., IP6K9K <i>Lateral LED Dir. Indicator Lamp PRO-PENNY, cat. 5, cable 0,5m, 12/24V, ADR appr., IP6K9K</i>	 Kategorie 5	
40 002 911	1	Seitliche LED Blinkleuchte PRO-PENNY , dito, Gehäuse glasklar <i>Lateral LED Dir. Indicator Lamp PRO-PENNY, dito, clear housing</i>	 Kategorie 5	
40 032 001	1	LED Blinkleuchte Kat. 5 u. 6, vordere-/seitliche Blinkleuchte Kabel 0,5m, 9-33V <i>LED Dir. Indicator Lamp, Cat. 5 and 6, cable 0,5m, 9-33V</i>	 Kategorie 5 + Kategorie 6	

Hintere LED Blinkleuchte

Rear LED Direction Indicator Lamp



Artikel-Nr. Reference-No.	VE QTY	Beschreibung Description	LED Blinkleuchten LED Dir. Indicator Lamps	LED Technik LED Technology
40 054 001	1	Hintere LED Blinkleuchte PRO-MINI-RING Aufbauversion, Kat. 2a, Kabel 0,5m, 12/24V, ADR-gepr., IP6K9K Rear LED Dir. Indicator Lamp PRO-MINI-RING , pendant version cat. 2a, cable 0,5m, 12/24V, ADR appr., IP6K9K		
40 054 501	1	Hintere LED Blinkleuchte PRO-MINI-RING , dito, Einbauversion Rear LED Dir. Indicator Lamp PRO-MINI-RING , dito, recessed version	 Kategorie 2a	 ADR
40 057 001	1	Hintere LED Blinkleuchte PRO-SQUARE , Kat. 2a, Kabel 0,5m 12/24V, ADR-gepr., IP6K9K Rear LED Dir. Indicator Lamp PRO-SQUARE , cat. 2a, cable 0,5m, 12/24V, ADR appr., IP6K9K	 Kategorie 2a	
40 031 001	1	Hintere LED Blinkleuchte mit brillianter FF-Spiegeloptik, Kat. 2a, Kabel 0,5m, 12/24V Rear LED Dir. Indicator Lamp, clear glas ff-optic with brilliant mirror, cat. 2a, cable 0,5m, 12/24V	 Kategorie 2a	
50 141 012 12V	1	LED Kontrollgerät PRO-CONTROL überwacht die Blinklichtfunktion Blinkerausfallkontrolle		LED Kontrollgerät siehe auch Katalogseite 9.9
50 141 024 24V	1	LED Control Gear PRO-CONTROL monitors the Direction Indicator function		LED Control Gear see also catalogue page 9.9

Vordere Blink-/Positionsleuchte

Front Direction Indicator-/Position Lamp



Artikel-Nr. Reference-No.	VE QTY	Beschreibung Description	LED Blink-/ Positionsleuchten LED Dir. Indicator-/ Front Position Lamps	LED Technik LED Technology
40 287 911	1	Vordere LED Blink-/Positionsleuchte Kat. 1a, Kabel 0,5m, wasserdichtes, vergossenes Leuchtgehäuse, Anbau horizontal o. vertikal, 12/24V - 3,5W, ARD geprüft - IP6K9K <i>LED Dir. Indicator-/ Front Position Lamp, cat. 1a incl. cable 0,5m, potted version, for horizontal or vertical fixation, 12/24V - 3,5W, ADR approved - IP6K9K</i>	 Kategorie 1a	
40 057 911	1	Vordere LED Blink-/Positionsleuchte PRO-SQUARE Kat. 1a, Kabel 0,5m, wasserdichtes, vergossenes Leuchtgehäuse, 12/24V, ARD geprüft - IP6K9K <i>Front LED Dir. Indicator-/ Position Lamp PRO-SQUARE cat. 1a incl. cable 0,5m, potted version, 12/24V, ADR approved - IP6K9K</i>	 Kategorie 1a	
40 058 911	1	Vordere LED Blink-/Positionsleuchte PRO-OVAL Kat. 1a, Kabel 0,5m, wasserdichtes, vergossenes Leuchtgehäuse, 12/24V, ARD geprüft - IP6K9K <i>Front LED Dir. Indicator-/ Position Lamp PRO-OVAL cat. 1a incl. cable 0,5m, potted version, 12/24V, ADR approved - IP6K9K</i>	 Kategorie 1a	
50 141 012 12V	1	LED Kontrollgerät PRO-CONTROL überwacht die Blinklichtfunktion Blinkerausfallkontrolle		LED Kontrollgerät siehe auch Katalogseite 9.9
50 141 024 24V	1	LED Control Gear PRO-CONTROL monitors the Direction Indicator function		LED Control Gear see also catalogue page 9.9

LED Zusatzbremsleuchte

3rd LED Stop Lamp



Artikel-Nr. Reference-No.	VE QTY	Beschreibung Description	LED Technik LED Technology
40 052 042 24V	1	LED Zusatzbremsleuchte PRO-STRIPE ECE II rot, Kabel 0,5m, wasserdichtes, vergossenes Leuchtgehäuse, 40 Hochleistungsdiode, Anbau horizontal, ADR-gepr. IP6K9K, 3W	
40 052 242 12V	1	3rd LED Stop Lamp PRO-STRIPE ECE II , red, cable 0,5m, 40 LED fitted in a waterproof housing, for horizontal fixation, ADR-gepr. IP6K9K, 3W	
40 026 412 24V	1	LED Zusatzbremsleuchte PRO-CAN XL rot, Kabel 0,5m, wasserdichtes, vergossenes Leuchtgehäuse, 18 Hochleistungsdiode, Anbau horizontal, ADR-gepr. IP67, 24/2W - 12V/2,5W	
40 026 312 12V	1	3rd LED Stop Lamp PRO-CAN XL , red, cable 0,5m, 18 LED fitted in a waterproof housing, for horizontal fixation, ADR-gepr. IP67, 24V/2W - 12V/2,5W	
40 606 002	1	LED-Zusatzbremsleuchte 12/24V Einbauversion, 9 Hochleistungsdiode, Gehäuse wasserdicht vergossen, Kabel 0,5m	
		3rd LED-Stop Lamp 12/24V recessed version, 9 LED fitted in a waterproof housing, cable 0,5m	
40 607 002	1	LED-Zusatzbremsleuchte 24V 28 Hochleistungsdiode, Gehäuse aus schlagfestem Kunststoff, wasserdicht vergossen, komplett inkl. Installationsmaterial, IP54 gepr.	
		3rd LED-Stop Lamp 24V 28 LED fitted in a waterproofed, solid plastic housing incl. Fixation Kit, IP54 appr.	
40 048 200	1	Befestigungskit PRO-STRIPE ECE inkl. Schrauben Mounting Kit PRO-STRIPE ECE incl. screws	
			40 48 200

Artikel-Nr. <i>Reference-No.</i>	Notizen <i>Notes</i>

LED Umrißleuchten	LED End Outline Marker Lamps	3.0	- 3.11
Umrißleuchten	End Outline Marker Lamps	3.12	- 3.19
LED Begrenzungsleuchten/ LED Schluß-Umrißleuchten	LED Front Position Lamps/ LED Rear Position Lamps	3.20	- 3.36
Begrenzungsleuchten/ Schluß-Umrißleuchten	Front Position Lamps/ Rear Position Lamps	3.37	- 3.38
Universal Positionsleuchten	Universal Position Lamps	3.39	



LED Umrißleuchte

LED End Outline Marker Lamp

Typ: **PRO-SUPER-JET**
 mit LED Seitenmarkierungsleuchte



Artikel-Nr. Reference-No.	VE QTY	Beschreibung Description	LED Umrißleuchten LED End Outline Marker Lamps	LED Technik 12V/24V LED Technology 12V/24V
40 004 014 <i>links/left</i>	1	LED Umrißleuchte PRO-SUPER-JET Lichtaustritt rot/weiss/gelb, Lichtleitertechnik mit Spiegeloptik, flex. Befestigungsarm, Lichtscheibeneinheit Kunststoff- ummantelt, ADR geprüft IP6K9K, Kabel 1,75m, 12V-1W, 24V-2W <i>LED End Outline Marker PRO-SUPER-JET Light Guide Technology with Mirror Optics, Lens red/white/amber, flex bracket, plastic-covered Lens, cable 1,75m, ADR appr. IP6K9K, 2V-1W, 24V-2W</i>		
40 004 015 <i>rechts/right</i>	1	LED Umrißleuchte PRO-SUPER-JET Lichtaustritt rot/weiss/gelb, Lichtleitertechnik mit Spiegeloptik, flex. Befestigungsarm, Lichtscheibeneinheit Kunststoff- ummantelt, ADR geprüft IP6K9K, Kabel 1,75m, 12V-1W, 24V-2W <i>LED End Outline Marker PRO-SUPER-JET Light Guide Technology with Mirror Optics, Lens red/white/amber, flex bracket, plastic-covered Lens, cable 1,75m, ADR appr. IP6K9K, 2V-1W, 24V-2W</i>		
40 004 314 <i>links/left</i>	1	LED Umrißleuchte PRO-SUPER-JET Lichtaustritt rot/weiss/gelb, Lichtleitertechnik mit Spiegeloptik, flex. Befestigungsarm, Lichtscheibeneinheit Kunststoff- ummantelt, ADR geprüft IP6K9K, Kabel 1,75m + P&R Stecker, 12V-1W, 24V-2W <i>LED End Outline Marker PRO-SUPER-JET Light Guide Technology with Mirror Optics, Lens red/white/amber, flex bracket, plastic-covered Lens, cable 1,75m + P&R connector, ADR appr. IP6K9K, 12V-1W, 24V-2W</i>		
40 004 315 <i>rechts/right</i>	1	LED Umrißleuchte PRO-SUPER-JET Lichtaustritt rot/weiss/gelb, Lichtleitertechnik mit Spiegeloptik, flex. Befestigungsarm, Lichtscheibeneinheit Kunststoff- ummantelt, ADR geprüft IP6K9K, Kabel 1,75m + P&R Stecker, 12V-1W, 24V-2W <i>LED End Outline Marker PRO-SUPER-JET Light Guide Technology with Mirror Optics, Lens red/white/amber, flex bracket, plastic-covered Lens, cable 1,75m + P&R connector, ADR appr. IP6K9K, 12V-1W, 24V-2W</i>		
40 005 004	1	LED Umrißleuchte PRO-SUPER-JET Lichtleitertechnik mit Spiegeloptik, flex. kurzer Befestigungsarm, Lichtscheibeneinheit Kunststoff- ummantelt, ADR geprüft IP6K9K, Kabel 1,75m, 12V-1W, 24V-2W <i>LED End Outline Marker PRO-SUPER-JET, Light Guide Technology with Mirror Optics, flex short bracket, plastic-covered Lens, cable 1,75m, ADR appr. IP6K9K, 12V-1W, 24V-2W</i>		
40 005 304	1	LED Umrißleuchte PRO-SUPER-JET dito, Kabel 1,75m + P&R Stecker <i>LED End Outline Marker PRO-SUPER-JET cable 1,75m + P&R connector</i>		
40 006 004	1	LED Umrißleuchte PRO-SUPER-JET Lichtleitertechnik mit Spiegeloptik, Anbaugeschäule, Lichtscheibeneinheit Kunststoff- ummantelt, ADR geprüft IP6K9K, Kabel 1,75m, 12V-1W, 24V-2W <i>LED End Outline Marker PRO-SUPER-JET, Light Guide Technology with Mirror Optics, plastic-covered Lens, cable 1,75m, ADR appr. IP6K9K, 12V-1W, 24V-2W</i>		
40 006 304	1	LED Umrißleuchte PRO-SUPER-JET dito, Kabel 1,75m + P&R Stecker <i>LED End Outline Marker PRO-SUPER-JET cable 1,75m + P&R connector</i>		

LED Umrißleuchte

LED End Outline Marker Lamp

Typ: **PRO-SUPER-JET**
mit LED Seitenmarkierungsleuchte



Artikel-Nr. Reference-No.	VE QTY	Beschreibung Description	LED Umrißleuchten LED End Outline Marker Lamps	LED Technik 12V/24V LED Technology 12V/24V
40 007 014 <i>links/left</i>	1	LED Umrißleuchte PRO-SUPER-JET Lichtaustritt rot/weiss/gelb, Lichtleitertechnik mit Spiegeloptik, Lichtscheibeneinheit Kunststoff- ummantelt, ADR geprüft IP6K9K, Kabel 1,75m, 12V-1W, 24V-2W <i>LED End Outline Marker PRO-SUPER-JET, Light Guide Technology with Mirror Optics, Lens red/white/amber, plastic-covered Lens, cable 1,75m, ADR appr. IP6K9K, 12V-1W, 24V-2W</i>		
40 007 015 <i>rechts/right</i>	1	LED Umrißleuchte PRO-SUPER-JET Lichtaustritt rot/weiss/gelb, Lichtleitertechnik mit Spiegeloptik, Lichtscheibeneinheit Kunststoff- ummantelt, ADR geprüft IP6K9K, Kabel 1,75m, 12V-1W, 24V-2W <i>LED End Outline Marker PRO-SUPER-JET, Light Guide Technology with Mirror Optics, Lens red/white/amber, plastic-covered Lens, cable 1,75m, ADR appr. IP6K9K, 12V-1W, 24V-2W</i>		
40 007 314 <i>links/left</i>	1	LED Umrißleuchte PRO-SUPER-JET Lichtaustritt rot/weiss/gelb, Lichtleitertechnik mit Spiegeloptik, Lichtscheibeneinheit Kunststoff- ummantelt, ADR geprüft IP6K9K, Kabel 1,75m + P&R Stecker, 12V-1W, 24V-2W <i>LED End Outline Marker PRO-SUPER-JET, Light Guide Technology with Mirror Optics, Lens red/white/amber, plastic-covered Lens, cable 1,75m + P&R connector, ADR appr. IP6K9K, 12V-1W, 24V-2W</i>		
40 007 315 <i>rechts/right</i>	1	LED Umrißleuchte PRO-SUPER-JET Lichtaustritt rot/weiss/gelb, Lichtleitertechnik mit Spiegeloptik, Lichtscheibeneinheit Kunststoff- ummantelt, ADR geprüft IP6K9K, Kabel 1,75m + P&R Stecker, 12V-1W, 24V-2W <i>LED End Outline Marker PRO-SUPER-JET, Light Guide Technology with Mirror Optics, Lens red/white/amber, plastic-covered Lens, cable 1,75m + P&R connector, ADR appr. IP6K9K, 12V-1W, 24V-2W</i>		
40 007 024 <i>links/left</i>	1	LED Umrißleuchte PRO-SUPER-JET Lichtaustritt rot/weiss/gelb, Lichtleitertechnik mit Spiegeloptik, flex. Pendelhalter, Lichtscheibeneinheit Kunststoff- ummantelt, ADR geprüft IP6K9K, Kabel 1,75m, 12V-1W, 24V-2W <i>LED End Outline Marker PRO-SUPER-JET, Light Guide Technology with Mirror Optics, Lens red/white/amber, flex bracket, plastic-covered Lens, cable 1,75m, ADR appr. IP6K9K, 12V-1W, 24V-2W</i>		
40 007 025 <i>rechts/right</i>	1	LED Umrißleuchte PRO-SUPER-JET Lichtaustritt rot/weiss/gelb, Lichtleitertechnik mit Spiegeloptik, flex. Pendelhalter, Lichtscheibeneinheit Kunststoff- ummantelt, ADR geprüft IP6K9K, Kabel 1,75m + P&R Stecker, 12V-1W, 24V-2W <i>LED End Outline Marker PRO-SUPER-JET, Light Guide Technology with Mirror Optics, Lens red/white/amber, flex bracket, plastic-covered Lens, cable 1,75m, ADR appr. IP6K9K, 12V-1W, 24V-2W</i>		
40 007 324 <i>links/left</i>	1	LED Umrißleuchte PRO-SUPER-JET Lichtaustritt rot/weiss/gelb, Lichtleitertechnik mit Spiegeloptik, flex. Pendelhalter, Lichtscheibeneinheit Kunststoff- ummantelt, ADR geprüft IP6K9K, Kabel 1,75m + P&R Stecker, 12V-1W, 24V-2W <i>LED End Outline Marker PRO-SUPER-JET, Light Guide Technology with Mirror Optics, Lens red/white/amber, flex bracket, plastic-covered Lens, cable 1,75m + P&R connector, ADR appr. IP6K9K, 12V-1W, 24V-2W</i>		
40 007 325 <i>rechts/right</i>	1	LED Umrißleuchte PRO-SUPER-JET Lichtaustritt rot/weiss/gelb, Lichtleitertechnik mit Spiegeloptik, flex. Pendelhalter, Lichtscheibeneinheit Kunststoff- ummantelt, ADR geprüft IP6K9K, Kabel 1,75m + P&R Stecker, 12V-1W, 24V-2W <i>LED End Outline Marker PRO-SUPER-JET, Light Guide Technology with Mirror Optics, Lens red/white/amber, flex bracket, plastic-covered Lens, cable 1,75m + P&R connector, ADR appr. IP6K9K, 12V-1W, 24V-2W</i>		

LED Umrißleuchte

LED End Outline Marker Lamp

Typ: PRO-JET

Artikel-Nr. Reference-No.	VE QTY	Beschreibung Description	LED Umrißleuchten LED End Outline Marker Lamps	LED Technik 12V/24V LED Technology 12V/24V
40 001 004	2	<p>LED Umrißleuchte PRO-JET in FF-Technik, Lichtaustritt rot/weiß, Leuchte komplett wasserdicht vergossen, Kabel 1,75m, ADR geprüft IP6K9K, 12V-0,8W, 24V-1,5W</p> <p><i>LED End Outline Marker PRO-JET in FF-Technology, Lens red/white, lamp complete waterproof casted, cable 1,75m, 12V-0,8W, 24V-1,5W, ADR approved IP6K9K</i></p>		
40 001 304	2	<p>LED Umrißleuchte PRO-JET in FF-Technik, Lichtaustritt rot/weiß, Leuchte komplett wasserdicht vergossen, Kabel 1,75m + P&R Stecker, ADR geprüft IP6K9K, 12V-0,8W, 24V-1,5W</p> <p><i>LED End Outline Marker PRO-JET in FF-Technology, Lens red/white, lamp complete waterproof casted, cable 1,75m + P&R con., 12V-0,8W, 24V-1,5W, ADR approved IP6K9K</i></p>		
40 001 024	2	<p>LED Umrißleuchte PRO-JET in FF-Technik, Lichtaustritt rot/weiß, Leuchte komplett wasserdicht vergossen, flex. Pendelhalter, Kabel 1,75m, ADR geprüft IP6K9K, 12V-0,8W, 24V-1,5W</p> <p><i>LED End Outline Marker PRO-JET in FF-Technology, Lens red/white, lamp complete waterproof casted, flex. bracket, cable 1,75m, 12V-0,8W, 24V-1,5W, ADR approved IP6K9K</i></p>		
40 001 324	2	<p>LED Umrißleuchte PRO-JET in FF-Technik, Lichtaustritt rot/weiß, Leuchte komplett wasserdicht vergossen, flex. Pendelhalter, Kabel 1,75m + P&R Stecker, ADR geprüft IP6K9K, 12V-0,8W, 24V-1,5W</p> <p><i>LED End Outline Marker PRO-JET in FF-Technology, Lens red/white, lamp complete waterproof casted, flex. bracket, cable 1,75m + P&R connector, 12V-0,8W, 24V-1,5W, ADR approved IP6K9K</i></p>		

LED Umrißleuchte

LED End Outline Marker Lamp

Typ: PRO-JET

Artikel-Nr. Reference-No.	VE QTY	Beschreibung Description	LED Umrißleuchten LED End Outline Marker Lamps	LED Technik 12V/24V LED Technology 12V/24V
40 001 204	2	<p>LED Umrißleuchte PRO-JET in FF-Technik, Lichtaustritt rot/weiß, Leuchte komplett wasserdicht vergossen, Flachkabel 0,5m, ADR geprüft IP6K9K, 12V-0,8W, 24V-1,5W</p> <p><i>LED End Outline Marker PRO-JET in FF-Technology, Lens red/white, lamp complete waterproof casted, flatcable 0,5m, 12V-0,8W, 24V-1,5W, ADR approved IP6K9K</i></p>		
NEW				
40 001 704	2	<p>LED Umrißleuchte PRO-JET in FF-Technik, Lichtaustritt rot/weiß, Leuchte komplett wasserdicht vergossen, AMP SuperSeal Stecker, ADR geprüft IP6K9K, 12V-0,8W, 24V-1,5W</p> <p><i>LED End Outline Marker PRO-JET in FF-Technology, Lens red/white, lamp complete waterproof casted, AMP SuperSeal connector, 12V-0,8W, 24V-1,5W, ADR approved IP6K9K</i></p>		
40 001 224	2	<p>LED Umrißleuchte PRO-JET in FF-Technik, Lichtaustritt rot/weiß, Leuchte komplett wasserdicht vergossen, flex. Pendelhalter, Flachkabel 1,75m, ADR geprüft IP6K9K, 12V-0,8W, 24V-1,5W</p> <p><i>LED End Outline Marker PRO-JET in FF-Technology, Lens red/white, lamp complete waterproof casted, flex. bracket, flatcable 1,75m, 12V-0,8W, 24V-1,5W, ADR approved IP6K9K</i></p>		
NEW				
40 001 724	2	<p>LED Umrißleuchte PRO-JET in FF-Technik, Lichtaustritt rot/weiß, Leuchte komplett wasserdicht vergossen, flex. Pendelhalter, AMP SuperSeal Stecker, ADR geprüft IP6K9K, 12V-0,8W, 24V-1,5W</p> <p><i>LED End Outline Marker PRO-JET in FF-Technology, Lens red/white, lamp complete waterproof casted, flex. bracket, AMP SuperSeal connector, 12V-0,8W, 24V-1,5W, ADR approved IP6K9K</i></p>		

LED Umrißleuchte

LED End Outline Marker Lamp

Typ: LED PRO-SUPERPOINT III mit LED Seitenmarkierungsleuchte



Artikel-Nr. Reference-No.	VE QTY	Beschreibung Description	LED Umrißleuchten LED End Outline Marker Lamps	LED Technik 12V/24V LED Technology 12V/24V
40 010 004	2	LED Umrissleuchte SUPERPOINT III in FF-Technik Lichtaustritt rot/weiss/gelb, flex. Befestigungsarm, Lichtscheibeneinheit aus bruchfestem PC, ADR gepr., Kabel 1,75m, 12V-0,5W, 24V-1W <i>LED End Outline Marker SUPERPOINT III in FF-Technology Lens red/white/amber, flex bracket, Lens made in PC, ADR appr., cable 1,75m, 12V-0,5W, 24V-1W</i>		
40 011 004	2	LED Umrissleuchte SUPERPOINT III in FF-Technik Lichtaustritt rot/weiss/gelb, flex. Anbaugehäuse, Lichtscheibeneinheit aus bruchfestem PC, ADR gepr., Kabel 1,75m, 12V-0,5W, 24V-1W <i>LED End Outline Marker SUPERPOINT III in FF-Technology Lens red/white/amber, flex housing, Lens made in PC, ADR appr., cable 1,75m, 12V-0,5W, 24V-1W</i>		
40 012 004	2	LED Umrissleuchte SUPERPOINT III in FF-Technik Lichtaustritt rot/weiss/gelb, flex. Pendelhalter, Lichtscheibeneinheit aus bruchfestem PC, ADR gepr., Kabel 1,75m, 12V-0,5W, 24V-1W <i>LED End Outline Marker SUPERPOINT III in FF-Technology Lens red/white/amber, flex bracket, Lens made in PC, ADR appr., cable 1,75m, 12V-0,5W, 24V-1W</i>		
40 013 004	2	LED Umrissleuchte SUPERPOINT III in FF-Technik Lichtaustritt rot/weiss/gelb, flex. Befestigungsarm, Lichtscheibe aus bruchfestem PC, ADR gepr., Kabel 1,75m, 12V-0,5W, 24V-1W <i>LED End Outline Marker SUPERPOINT III in FF-Technology Lens red/white/amber, flex short bracket, Lens made in PC, ADR appr., cable 1,75m, 12V-0,5W, 24V-1W</i>		
40 010 105	2	LED Einheit mit Kabel 1,75m, 12V-0,5W / 24V-1W <i>LED Unit incl. cable 1,75m, 12V-0,5W / 24V-1W</i>		
40 010 104	10	Lichtscheibeneinheit aus bruchfestem PC, rot/weiss/gelb <i>Lens made in PC, red/white/amber</i>		

40 010 105

40 010 104

LED Umrißleuchte

LED End Outline Marker Lamp

**Typ: LED PRO-SUPERPOINT III
mit LED Seitenmarkierungsleuchte**



Artikel-Nr. Reference-No.	VE QTY	Beschreibung Description	LED Umrißleuchten LED End Outline Marker Lamps	LED Technik 12V/24V LED Technology 12V/24V
40 010 304	2	<p>LED Umrissleuchte SUPERPOINT III in FF-Technik Lichtaustritt rot/weiss/gelb, flex. Befestigungsarm, Lichtscheibe aus bruchfestem PC, ADR. gepr., Kabel 1,75m + P&R Stecker, 12V-0,5W, 24V-1W</p> <p>LED End Outline Marker SUPERPOINT III in FF-Technology Lens red/white/amber, flex bracket, Lens made in PC, ADR appr., cable 1,75m + P&R connector, 12V-0,5W, 24V-1W</p>		
40 011 304	2	<p>LED Umrissleuchte SUPERPOINT III in FF-Technik Lichtaustritt rot/weiss/gelb, flex. Anbauehäuse, Lichtscheibe aus bruchfestem PC, ADR gepr., Kabel 1,75m + P&R Stecker, 12V-0,5W, 24V-1W</p> <p>LED End Outline Marker SUPERPOINT III in FF-Technology Lens red/white/amber, flex housing, Lens made in PC, ADR appr., cable 1,75m + P&R connector, 12V-0,5W, 24V-1W</p>		
40 012 304	2	<p>LED Umrissleuchte SUPERPOINT III in FF-Technik Lichtaustritt rot/weiss/gelb, flex. Pendelhalter, Lichtscheibe aus bruchfestem PC, ADR gepr., Kabel 1,75m + P&R Stecker, 12V-0,5W, 24V-1W</p> <p>LED End Outline Marker SUPERPOINT III in FF-Technology Lens red/white/amber, flex bracket, Lens made in PC, ADR appr., cable 1,75m + P&R connector, 12V-0,5W, 24V-1W</p>		
40 013 304	2	<p>LED Umrissleuchte SUPERPOINT III in FF-Technik Lichtaustritt rot/weiss/gelb, flex. Befestigungsarm, Lichtscheibe aus bruchfestem PC, ADR gepr., Kabel 1,75m + P&R Stecker, 12V-0,5W, 24V-1W</p> <p>LED End Outline Marker SUPERPOINT III in FF-Technology Lens red/white/amber, flex short bracket, Lens made in PC, ADR appr., cable 1,75m + P&R connector, 12V-0,5W, 24V-1W</p>		
40 010 205	2	<p>LED Einheit mit Kabel 1,75m + P&R Stecker, 12V-0,5W / 24V-1W</p> <p>LED Unit incl. cable 1,75m + P&R connector, 12V-0,5W / 24V-1W</p>		
40 010 104	10	<p>Lichtscheibeneinheit aus bruchfestem PC, rot/weiss/gelb</p> <p>Lens made in PC, red/white/amber</p>		

LED Umrißleuchte

LED End Outline Marker Lamp

**Typ: LED PRO-SUPERPOINT III
mit LED Seitenmarkierungsleuchte**



Artikel-Nr. Reference-No.	VE QTY	Beschreibung Description	LED Umrißleuchten LED End Outline Marker Lamps	LED Technik 12V/24V LED Technology 12V/24V
40 010 214 links/left	1	<p>LED Umrissleuchte SUPERPOINT III in FF-Technik links, Lichtaustritt rot/weiß/gelb, flex. Befestigungsarm, Lichtscheibeneinheit aus bruchfestem PC, ADR. gepr., Flachkabel 0,5m, 12V-0,5W, 24V-1W</p> <p><i>LED End Outline Marker SUPERPOINT III in FF-Technology, left, Lens red/white/amber, flex bracket, Lens made in PC, ADR appr., flat cable 0,5m, 12V-0,5W, 24V-1W</i></p>		
40 010 215 rechts/right	1	<p>LED Umrissleuchte SUPERPOINT III in FF-Technik rechts, Lichtaustritt rot/weiß/gelb, flex. Befestigungsarm, Lichtscheibeneinheit aus bruchfestem PC, ADR. gepr., Flachkabel 0,5m, 12V-0,5W, 24V-1W</p> <p><i>LED End Outline Marker SUPERPOINT III in FF-Technology, right, Lens red/white/amber, flex bracket, Lens made in PC, ADR appr., flat cable 0,5m, 12V-0,5W, 24V-1W</i></p>		

LED Umrissleuchte

LED End Outline Marker Lamp

**Typ: LED PRO-SUPERPOINT III ECO
mit LED Seitenmarkierungsleuchte**



Artikel-Nr. Reference-No.	VE QTY	Beschreibung Description	LED Umrissleuchten LED End Outline Marker Lamps	ohne Spiegeltechnik without mirror optics
40 010 904	2	<p>LED Umrissleuchte SUPERPOINT III ECO Lichtaustritt rot/weiss/gelb, flex. Befestigungsarm, Lichtscheibeneinheit aus bruchfestem PC, ADR. gepr., Kabel 0,5m, 12V-0,5W, 24V-1W</p> <p>LED End Outline Marker SUPERPOINT III ECO Lens red/white/amber, flex bracket, Lens made in PC, ADR appr., cable 0,5m, 12V-0,5W, 24V-1W</p>		
40 011 904	2	<p>LED Umrissleuchte SUPERPOINT III ECO Lichtaustritt rot/weiss/gelb, flex. Anbauehäuse, Lichtscheibeneinheit aus bruchfestem PC, ADR gepr., Kabel 0,5m, 12V-0,5W, 24V-1W</p> <p>LED End Outline Marker SUPERPOINT III ECO Lens red/white/amber, flex housing, Lens made in PC, ADR appr., cable 0,5m, 12V-0,5W, 24V-1W</p>		
40 012 944	2	<p>LED Umrissleuchte SUPERPOINT III ECO Lichtaustritt rot/weiss/gelb, flex. Pendelhalter, Lichtscheibeneinheit aus bruchfestem PC, ADR gepr., Kabel 0,5m, 12V-0,5W, 24V-1W</p> <p>LED End Outline Marker SUPERPOINT III ECO Lens red/white/amber, flex bracket, Lens made in PC, ADR appr., cable 0,5m, 12V-0,5W, 24V-1W</p>		
40 013 904	2	<p>LED Umrissleuchte SUPERPOINT III ECO Lichtaustritt rot/weiss/gelb, flex. Befestigungsarm, Lichtscheibe aus bruchfestem PC, ADR gepr., Kabel 0,5m, 12V-0,5W, 24V-1W</p> <p>LED End Outline Marker SUPERPOINT III ECO Lens red/white/amber, flex short bracket, Lens made in PC, ADR appr., cable 0,5m, 12V-0,5W, 24V-1W</p>		

LED Umrißleuchte

LED End Outline Marker Lamp

Typ: LED SUPERPOINT

Artikel-Nr. Reference-No.	VE QTY	Beschreibung Description	LED Umrißleuchten LED End Outline Marker Lamps	LED Technik 24V LED Technology 24V
40 167 004	2	<p>LED Umrißleuchte SUPERPOINT Lichtaustritt rot/weiß, flex. Befestigungsarm 90°, Lichtscheibeneinheit aus bruchfestem PC, ADR geprüft, Kabel 1,75m, 24V/0,85W</p> <p><i>LED End Outline Marker SUPERPOINT Lens red/white, flex bracket 90°, Lens made in PC, ADR approved, cable 1,75m, 24V/0,85W</i></p>	 <p>Lichtaustritt rot/weiß Light Red/White</p>	
40 167 304	2	<p>LED Umrißleuchte SUPERPOINT dito., Kabel 1,75m + P&R Stecker</p> <p><i>LED End Outline Marker SUPERPOINT dito., cable 1,75m + P&R con.</i></p>		
40 168 004	2	<p>LED Umrißleuchte SUPERPOINT Lichtaustritt rot/weiß, flex. kurzer Befestigungsarm, Lichtscheibeneinheit aus bruchfestem PC, ADR geprüft, Kabel 1,75m, 24V/0,85W</p> <p><i>LED End Outline Marker Lamp SUPERPOINT Lens red/white, flex short bracket, Lens made in PC, ADR approved, cable 1,75m, 24V/0,85W</i></p>	 <p>Lichtaustritt rot/weiß Light Red/White</p>	
40 168 304	2	<p>LED Umrißleuchte SUPERPOINT dito., Kabel 1,75m + P&R Stecker</p> <p><i>LED End Outline Marker SUPERPOINT dito., cable 1,75m + P&R con.</i></p>		
40 169 004	2	<p>LED Umrißleuchte SUPERPOINT Lichtaustritt rot/weiß, flex. Befestigungsarm 60°, Lichtscheibeneinheit aus bruchfestem PC, ADR geprüft, Kabel 1,75m, 24V/0,85W</p> <p><i>LED End Outline Marker Lamp SUPERPOINT Lens red/white, flex bracket 60°, Lens made in PC, ADR approved, cable 1,75m, 24V/0,85W</i></p>	 <p>Lichtaustritt rot/weiß Light Red/White</p>	
40 167 104	2	<p>LED Lichtscheibeneinheit für Umrißleuchte SUPERPOINT, ADR geprüft, Kabel 1,75m</p> <p><i>LED Lens for End Outline Marker Lamp SUPERPOINT, cable 1,75m,</i></p>		

LED Umrißleuchte

LED End Outline Marker Lamp

Typ: LED SUPERPOINT

Artikel-Nr. Reference-No.	VE QTY	Beschreibung Description	LED Umrißleuchten LED End Outline Marker Lamps	LED Technik 24V LED Technology 24V
40 189 004	2	<p>LED Umrißleuchte SUPERPOINT Lichtaustritt rot/weiß, flex. Anbaueinheit, Lichtscheibeneinheit aus bruchfestem PC, ADR geprüft, Kabel 1,75m, 24V/0,85W</p> <p><i>LED End Outline Marker SUPERPOINT Lens red/white, flex housing, Lens made in PC, ADR approved, cable 1,75m, 24V/0,85W</i></p>		
40 189 304	2	<p>LED Umrißleuchte SUPERPOINT dito., Kabel 1,75m + P&R Stecker</p> <p><i>LED End Outline Marker SUPERPOINT dito., cable 1,75m + P&R con.</i></p>	<p>Lichtaustritt rot/weiß <i>Light Red/White</i></p>	
40 190 004	2	<p>LED Umrißleuchte SUPERPOINT Lichtaustritt rot/weiß, flex. Pendelhalter, Lichtscheibeneinheit aus bruchfestem PC, ADR geprüft, Kabel 1,75m, 24V/0,85W</p> <p><i>LED End Outline Marker Lamp SUPERPOINT Lens red/white, flex bracket, Lens made in PC, ADR approved, cable 1,75m, 24V/0,85W</i></p>	<p>Lichtaustritt rot/weiß <i>Light Red/White</i></p>	<p>Befestigungslochabstand 15mm bzw. 30mm Distance fixation holes 15mm or 30mm</p>
40 191 004	2	<p>LED Umrißleuchte SUPERPOINT Lichtaustritt rot/weiß, flex. Pendelhalter 90°, Lichtscheibeneinheit aus bruchfestem PC, ADR geprüft, Kabel 1,75m, 24V/0,85W</p> <p><i>LED End Outline Marker Lamp SUPERPOINT Lens red/white, flex bracket 90°, Lens made in PC, ADR approved, cable 1,75m, 24V/0,85W</i></p>	<p>Lichtaustritt rot/weiß <i>Light Red/White</i></p>	<p>Befestigungslochabstand 15mm bzw. 30mm Distance fixation holes 15mm or 30mm</p>
40 167 104	2	<p>LED Lichtscheibeneinheit für Umrißleuchte SUPERPOINT, ADR geprüft, Kabel 1,75m</p> <p><i>LED Lens for End Outline Marker Lamp SUPERPOINT, cable 1,75m,</i></p>		

LED Umrißleuchte

LED End Outline Marker Lamp

Typ: LED SUPERPOINT II

Artikel-Nr. Reference-No.	VE QTY	Beschreibung Description	LED Umrißleuchten LED End Outline Marker Lamps	LED Technik 24V LED Technology 24V
40 018 004	2	<p>LED Umrißleuchte SUPERPOINT II Lichtaustritt rot/weiß/gelb, flex. Befestigungsarm, Lichtscheibeneinheit aus bruchfestem PC, ADR. gepr., Kabel 1,75m, 24V/1W</p> <p><i>LED End Outline Marker SUPERPOINT II Lens red/white/amber, flex bracket, Lens made in PC, ADR appr., cable 1,75m, 24V/1W</i></p>		
40 018 014	2	<p>LED Umrißleuchte SUPERPOINT II Lichtaustritt rot/weiß/gelb, gerader flex. Befestigungsarm, Lichtscheibeneinheit aus bruchfestem PC, ADR. gepr., Kabel 1,75m, 24V/1W</p> <p><i>LED End Outline Marker SUPERPOINT II Lens red/white/amber, straight flex bracket, Lens made in PC, ADR appr., cable 1,75m, 24V/1W</i></p>		
40 018 024	2	<p>LED Umrißleuchte SUPERPOINT II für ECOPOINT Schlußleuchte, Lichtaustritt rot/weiß/gelb, kurzer flex. Befestigungsarm, Lichtscheibeneinheit aus bruchfestem PC, ADR. gepr., Kabel 1,75m, 24V/1W</p> <p><i>LED End Outline Marker SUPERPOINT II for ECOPOINT rear lamp, Lens red/white/amber, short flex bracket, Lens made in PC, ADR appr., cable 1,75m, 24V/1W</i></p>		
40 018 104	2	<p>LED Lichtscheibeneinheit für Umrißleuchte SUPERPOINT II, ADR Kabel 1,75m</p> <p><i>LED Lens for End Outline Marker Lamp SUPERPOINT II, ADR cable 1,75m</i></p>		

LED Umrißleuchte

LED End Outline Marker Lamp

Typ: PRO-STAR

Artikel-Nr. Reference-No.	VE QTY	Beschreibung Description	LED Umrißleuchten LED End Outline Marker Lamps	LED Technik 12V/24V LED Technology 12V/24V
40 100 004	2	<p>LED Umrißleuchte PRO-STAR Lichtaustritt rot/weiß, Leuchte komplett wasserdicht vergossen, Kabel 0,5m, ADR geprüft, 12V-0,85W, 24V-1,8W</p> <p><i>LED End Outline Marker PRO-STAR, Lens red/white, lamp complete waterproof casted, cable 0,5m, 12V-0,85W, 24V-1,8W, ADR</i></p>		
40 100 504	2	<p>LED Umrißleuchte PRO-STAR Lichtaustritt rot/weiß, Leuchte komplett wasserdicht vergossen, Gehäuse weiß, Kabel 0,5m, ADR, 12V-0,85W, 24V-1,8W</p> <p><i>LED End Outline Marker PRO-STAR, Lens red/white, lamp complete waterproof casted, white housing, cable 0,5m, 12V-0,85W, 24V-1,8W, ADR</i></p>		
40 100 024	2	<p>LED Umrißleuchte PRO-STAR Lichtaustritt rot/weiß, Leuchte komplett wasserdicht vergossen, flexibler Pendelhalter, Kabel 0,5m, ADR geprüft, 12V-0,85W, 24V-1,8W</p> <p><i>LED End Outline Marker PRO-STAR, Lens red/white, lamp complete waterproof casted, flex. bracket, cable 0,5m, 12V-0,85W, 24V-1,8W, ADR</i></p>		

Umrißleuchte

End Outline Marker Lamp

Typ: PRO-SUPERPOINT III mit Seitenmarkierungsleuchte



Artikel-Nr. Reference-No.	VE QTY	Beschreibung Description	Umrißleuchten End Outline Marker Lamps	BA 9s / T4W
40 107 004	2	Umrißleuchte SUPERPOINT III in FF-Technik Lichtaustritt rot/weiß/gelb, flex. Befestigungsarm, Lichtscheibeneinheit aus bruchfestem PC, inkl. Glühlampe 24V/4W, Kabel 1,75m, 12V/24V <i>End Outline Marker SUPERPOINT III, in FF-Technology Lens red/white/amber, flex bracket, Lens made in PC, incl. bulb 24V/4W cable 1,75m, 12V/24V</i>		
40 108 004	2	Umrißleuchte SUPERPOINT III in FF-Technik Lichtaustritt rot/weiß/gelb, flex. Anbaugehäuse, Lichtscheibeneinheit aus bruchfestem PC, inkl. Glühlampe 24V/4W, Kabel 1,75m, 12V/24V <i>End Outline Marker SUPERPOINT III, in FF-Technology Lens red/white/amber, flex housing, Lens made in PC, incl. bulb 24V/4W cable 1,75m, 12V/24V</i>		
40 109 004	2	Umrißleuchte SUPERPOINT III in FF-Technik Lichtaustritt rot/weiß/gelb, flex. Pendelhalter, Lichtscheibeneinheit aus bruchfestem PC, inkl. Glühlampe 24V/4W, Kabel 1,75m, 12V/24V <i>End Outline Marker SUPERPOINT III, in FF-Technology Lens red/white/amber, flex bracket, Lens made in PC, incl. bulb 24V/4W cable 1,75m, 12V/24V</i>		
40 110 004	2	Umrißleuchte SUPERPOINT III in FF-Technik Lichtaustritt rot/weiß/gelb, flex. kurzer Befestigungsarm, Lichtscheibe aus bruchfestem PC, inkl. Glühl. 24V/4W, Kabel 1,75m, 12V/24V <i>End Outline Marker SUPERPOINT III, in FF-Technology Lens red/white/amber, flex short bracket, Lens made in PC, incl. bulb 24V/4W cable 1,75m, 12V/24V</i>		
40 107 105	10	Fassungsgehäuse mit Glühlampe 24V/4W, Kabel 1,75m <i>Bulb holder incl. bulb 24V/4W, cable 1,75m</i>		
40 107 104	10	Lichtscheibeneinheit aus bruchfestem PC, rot/weiß/gelb <i>Lens made in PC, red/white/amber</i>		

Umrißleuchte

End Outline Marker Lamp

**Typ: PRO-SUPERPOINT III
 mit Seitenmarkierungsleuchte**

Artikel-Nr. Reference-No.	VE QTY	Beschreibung Description	Umrißleuchten End Outline Marker Lamps	BA 9s / T4W
40 107 304	2	Umrißleuchte SUPERPOINT III in FF-Technik Lichtaustritt rot/weiß/gelb, flex. Befestigungsarm, Lichtscheibeneinheit aus bruchfestem PC, inkl. Glühlampe 24V/4W, Kabel 1,75m + P&R St. <i>End Outline Marker SUPERPOINT III, in FF-Technology Lens red/white/amber, flex bracket, Lens made in PC, incl. bulb 24V/4W cable 1,75m + P&R con.</i>		
40 108 304	2	Umrißleuchte SUPERPOINT III in FF-Technik Lichtaustritt rot/weiß/gelb, flex. Anbaugehäuse, Lichtscheibeneinheit aus bruchfestem PC, inkl. Glühlampe 24V/4W, Kabel 1,75m + P&R St. <i>End Outline Marker SUPERPOINT III, in FF-Technology Lens red/white/amber, flex housing, Lens made in PC, incl. bulb 24V/4W cable 1,75m + P&R con.</i>		
40 109 304	2	Umrißleuchte SUPERPOINT III in FF-Technik Lichtaustritt rot/weiß/gelb, flex. Pendelhalter, Lichtscheibeneinheit aus bruchfestem PC, inkl. Glühlampe 24V/4W, Kabel 1,75m + P&R St. <i>End Outline Marker SUPERPOINT III, in FF-Technology Lens red/white/amber, flex bracket, Lens made in PC, incl. bulb 24V/4W cable 1,75m + P&R con.</i>		
40 110 304	2	Umrißleuchte SUPERPOINT III in FF-Technik Lichtaustritt rot/weiß/gelb, flex. kurzer Befestigungsarm, Lichtscheibe aus bruchfestem PC, inkl. Glühl. 24V/4W, Kabel 1,75m + P&R St. <i>End Outline Marker SUPERPOINT III, in FF-Technology Lens red/white/amber, flex short bracket, Lens made in PC, incl. bulb 24V/4W cable 1,75m + P&R con.</i>		
40 107 205	10	Fassungsgehäuse mit Glühlampe 24V/4W, Kabel 1,75m + P&R St. <i>Bulb holder incl. bulb 24V/4W, cable 1,75m + P&R connector</i>		
40 107 104	10	Lichtscheibeneinheit aus bruchfestem PC, rot/weiß/gelb <i>Lens made in PC, red/white/amber</i>		

Umrißleuchte

End Outline Marker Lamp

Typ: SUPERPOINT

Artikel-Nr. Reference-No.	VE QTY	Beschreibung Description	Umrißleuchten End Outline Marker Lamps	BA 9s / T4W
40 153 004	2	Umrißleuchte SUPERPOINT Lichtaustritt rot/weiß, flex. Befestigungsarm 90°, Lichtscheibeneinheit aus bruchfestem PC, inkl. Glühlampe 24V/4W, Kabel 0,5m, 12V/24V <i>End Outline Marker Lamp SUPERPOINT Lens red/white, flex bracket 90, Lens made in PC, incl. bulb 24V/4W cable 0,5m, 12V/24V</i>		
40 158 004	2	Umrißleuchte SUPERPOINT Lichtaustritt rot/weiß, flex. kurzer Befestigungsarm, Lichtscheibeneinheit aus bruchfestem PC, inkl. Glühlampe 24V/4W, Kabel 0,5m, 12V/24V <i>End Outline Marker Lamp SUPERPOINT Lens red/white, flex short bracket, Lens made in PC, incl. bulb 24V/4W cable 0,5m, 12V/24V</i>		
40 159 004	2	Umrißleuchte SUPERPOINT Lichtaustritt rot/weiß, flex. Befestigungsarm 60°, Lichtscheibeneinheit aus bruchfestem PC, inkl. Glühlampe 24V/4W, Kabel 0,5m, 12V/24V <i>End Outline Marker Lamp SUPERPOINT Lens red/white, flex bracket 60, Lens made in PC, incl. bulb 24V/4W, cable 0,5m, 12V/24V</i>		
40 188 004	2	Umrißleuchte SUPERPOINT Lichtaustritt rot/weiß, flex. Anbaugehäuse, Lichtscheibeneinheit aus bruchfestem PC, inkl. Glühlampe 24V/4W, Kabel 0,5m, 12V/24V <i>End Outline Marker Lamp SUPERPOINT Lens red/white, flex. housing, Lens made in PC, incl. bulb 24V/4W, cable 0,5m, 12V/24V</i>		
40 153 104	10	Lichtscheibeneinheit aus bruchfestem PC, rot/weiß <i>Lens made in PC, red/white</i>		40 153 104
40 153 105	10	Fassungsgehäuse mit Glühlampe 24V/4W, Kabel 0,5m <i>Bulb holder incl. bulb 24V/4W, cable 0,5m</i>		40 153 105
40 153 205	10	Fassungsgehäuse mit Glühlampe 24V/4W, Kabel 2,0m <i>Bulb holder incl. bulb 24V/4W, cable 2,0m</i>		40 153 205

Umrißleuchte







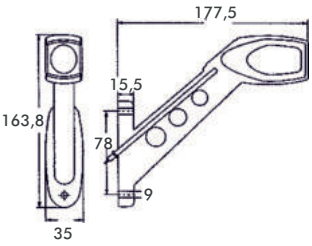

End Outline Marker Lamp

Typ: SUPERPOINT II

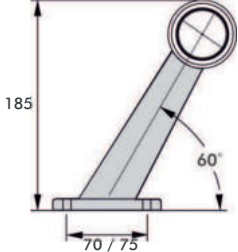
Artikel-Nr. Reference-No.	VE QTY	Beschreibung Description	Umrißleuchten End Outline Marker Lamps	BA 9s / T4W
31 340 401 Aspöck-Nr.: 31-3404-017	2	Umrißleuchte SUPERPOINT II Lichtaustritt rot/weiß, integr. Seitenmarkierungsleuchte, flex. Befestigungsarm, Lichtscheibe aus bruchfestem PC, inkl. Glühlampe 24V/4W, Kabel 1,25m mit P&R St. <i>End Outline Marker SUPERPOINT II Lens red/white, integr. sidemarker lamp, flex bracket, Lens made in PC, incl. bulb 24V/4W, cable 1,25m with Aspöck P&R con.</i>		
31 340 708 rechts/right Aspöck-Nr.: 31-3407-087	2	Umrißleuchte SUPERPOINT II Lichtaustritt rot/weiß, integr. Seitenmarkierungsleuchte, flex. Befestigungsarm, Lichtscheibe aus bruchfestem PC, inkl. Glühlampe 24V/4W, Kabel 1,98m mit ASS1 St.		
31 340 709 links/left Aspöck-Nr.: 31-3407-097	2	End Outline Marker SUPERPOINT II Lens red/white, integr. sidemarker lamp, flex bracket, Lens made in PC, incl. bulb 24V/4W, cable 1,98m with Aspöck ASS1 con.	 Version SCHMITZ	
31 370 408 Aspöck-Nr.: 31-3704-087	2	Umrißleuchte SUPERPOINT II Lichtaustritt rot/weiß, integr. Seitenmarkierungsleuchte, flex. Befestigungsarm, Lichtscheibe aus bruchfestem PC, inkl. Glühlampe 24V/4W, Kabel 1,25m mit P&R St. <i>End Outline Marker SUPERPOINT II Lens red/white, integr. sidemarker lamp, flex bracket, Lens made in PC, incl. bulb 24V/4W, cable 1,25m with Aspöck P&R con.</i>		
31 360 801 Aspöck-Nr.: 31-3608-017	2	Umrißleuchte SUPERPOINT II für ECOPOINT Schlußleuchte, Lichtaustritt rot/weiß, integr. Seitenmarkierungsleuchte, flex. Befestigungsarm, Lichtscheibe aus bruchfestem PC, inkl. Glühlampe 24V/4W, Kabel 1,25m mit P&R St. <i>End Outline Marker SUPERPOINT II for ECOPOINT rear lamp, integr. sidemarker lamp, Lens red/white made in PC, flex bracket, incl. bulb 24V/4W</i>		
18 813 600 Aspöck-Nr.: 18-8136-007	10	Lichtscheibeneinheit mit integr. Seitenmarkierungsleuchte aus bruchfestem PC <i>Lens with integrated sidemarker lamp made in PC</i>		
40 018 104	2	LED Lichtscheibeneinheit für Umrißleuchte SUPERPOINT II , ADR Kabel 1,75m <i>LED Lens for End Outline Marker Lamp SUPERPOINT II, ADR cable 1,75m</i>		 LED

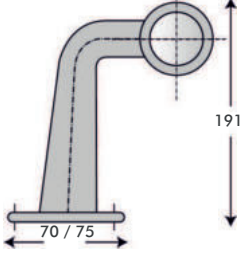





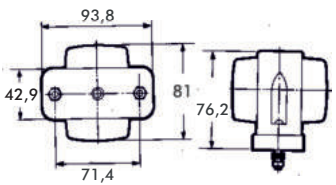

Umrißleuchte

End Outline Marker Lamp

Artikel-Nr. Reference-No.	VE QTY	Beschreibung Description	Umrißleuchten End Outline Marker Lamps	
40 137 504	1	LED Umrißleuchte, Lichtaustritt rot/weiß/gelb,flex. Befestig. Kabel 0,5m mit EasyCon-St., links, 24V <i>LED End Outline Marker, Lens red/white/amber, flex bracket, cable 0,5m with EasyCon-Connector, left, 24V</i>		
40 137 514	1	LED Umrißleuchte, dito. rechts <i>LED End Outline Marker, right</i>		
40 116 004	2	Umrißleuchte Lichtaustritt rot/weiß, flex. Befestigungsarm 60°, vorverkabelt <i>End Outline Marker Lamp, Lens red/white, flex bracket 60°, incl. cable</i>		BA 15s / R5W 
40 118 102	10	Lichtscheibe rot Ø51mm <i>Lens red Ø51mm</i>		
40 118 103	10	Lichtscheibe weiß Ø51mm <i>Lens white Ø51mm</i>		
40 118 004	2	Umrißleuchte Lichtaustritt rot/weiß, flex. Befestigungsarm 90°, vorverkabelt <i>End Outline Marker Lamp, Lens red/white, flex bracket 90°, incl. cable</i>		BA 15s / R5W 
40 118 102	10	Lichtscheibe rot Ø51mm <i>Lens red Ø51mm</i>		
40 118 103	10	Lichtscheibe weiß Ø51mm <i>Lens white Ø51mm</i>		
40 116 102	10	Lichtscheibe rot Ø54mm <i>Lens red Ø54mm</i>		
40 116 103	10	Lichtscheibe weiß Ø54mm <i>Lens white Ø54mm</i>		
			40 116 102	40 116 103
40 116 105	10	Fassung für Umrißleuchte mit Kabel <i>Bulb holder incl. cable</i>		
40 116 205	10	Fassung für Umrißleuchte mit Schraubanschluß <i>Bulb holder</i>		
			40 116 105	40 116 205

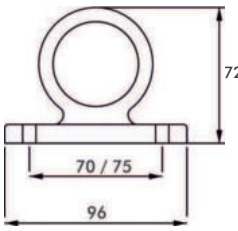
Umrißleuchte

End Outline Marker Lamp

Artikel-Nr. Reference-No.	VE QTY	Beschreibung Description	Umrißleuchten End Outline Marker Lamps	
40 117 004	2	Umrißleuchte Lichtaustritt rot/weiß, montiert im Gummisockel, <i>End Outline Marker Lamp, Lens red/white mounted in a rubber housing</i>		BA 15S / R5W 
40 117 102	10	Lichtscheibe rot für Umrißleuchte 40 117 004 <i>Lens red for end outline marker lamp 40 117 004</i>		
40 117 103	10	Lichtscheibe weiß für Umrißleuchte 40 117 004 <i>Lens white for end outline marker lamp 40 117 004</i>	40 117 102	40 117 203
40 127 004	2	Umrißleuchte Lichtaustritt rot/weiß, montiert im Gummisockel, vorverkabelt <i>End Outline Marker Lamp, Lens red/white mounted in a rubber housing incl. cable</i>		BA 15S / R5W 
40 118 102	10	Lichtscheibe rot für Umrißleuchte 40 127 004 <i>Lens red for end outline marker 40 127 004</i>		
40 118 103	10	Lichtscheibe weiß für Umrißleuchte 40 127 004 <i>Lens white for end outline marker 40 127 004</i>		
40 116 205	10	Fassung für Umrißleuchte 40 127 004 mit Kabel <i>Bulb holder incl. cable</i>	40 118 102	40 118 103
				
				40 116 105

Umrißbleuchte

End Outline Marker Lamp

Artikel-Nr. Reference-No.	VE QTY	Beschreibung Description	Umrißbleuchten End Outline Marker Lamps	
40 101 004	10	Umrißbleuchte Lichtscheibe rot/weiß <i>End Outline Marker Lamp Lens red/white</i>		 BA 9s / T4W
40 101 104	10	Lichtscheibe rot/weiß <i>Lens red/white</i>		
40 102 004	10	Umrißbleuchte Lichtscheibe rot/weiß, flex. Pendelhalter <i>End Outline Marker Lamp Lens red/white, flex. bracket</i>		 BA 9s / T4W
40 103 004	10	Umrißbleuchte Lichtscheibe rot/weiß, flex. 90° Pendelhalter <i>End Outline Marker Lamp Lens red/white, flex. 90° bracket</i>		 BA 9s / T4W
40 170 004	10	Umrißbleuchte Lichtscheibe rot/weiß <i>End Outline Marker Lamp Lens red/white</i>		 BA 15S / R5W
40 170 104	10	Lichtscheibe rot/weiß <i>Lens red/white</i>		
40 171 004	10	Umrißbleuchte Lichtscheibe rot/weiß, flex. Pendelhalter <i>End Outline Marker Lamp Lens red/white, flex. bracket</i>		 BA 15s / R5W
40 170 104	10	Lichtscheibe rot/weiß <i>Lens red/white</i>		
40 104 004	10	Umrißbleuchte Lichtscheibe rot/weiß, flex. Pendelhalter <i>End Outline Marker Lamp Lens red/white, flex. bracket</i>		 SV 8,5 / C5W
40 104 104	10	Lichtscheibe rot/weiß <i>Lens red/white</i>		RENAULT: 5000409926 VALEO: FES 88A

Umrißleuchte

End Outline Marker Lamp

Typ: **FLEXIPOINT**









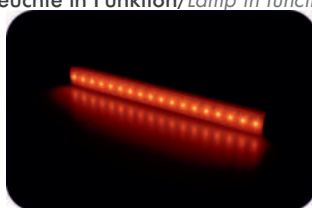
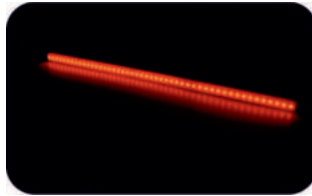
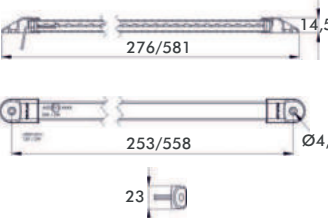

Artikel-Nr. Reference-No.	VE QTY	Beschreibung Description	Umrißleuchten End Outline Marker Lamps	SV 8,5 / C5W
31 650 904 Aspöck-Nr.: 31-6509-047	2	Umrißleuchte FLEXIPOINT Lichtscheibe rot/weiß, Kabel 0,5m mit Aspöck DC-Stecksystem, 12V, 65x44x23 <i>End Outline Marker Lamp, FLEXIPOINT, Lens red/white, cable 0,5m with Aspöck DC-Connector System, 65x44x23</i>		
18 816 503 Aspöck-Nr.: 18-8165-037	10	Lichtscheibe rot/weiß, für FLEXIPOINT Umrißleuchte <i>Lens for End Outline Marker FLEXIPOINT</i>		
31 656 906 Aspöck-Nr.: 31-6569-067	2	Umrißleuchte FLEXIPOINT Lichtscheibe rot/weiß, Flex. Pendelhalter, Kabel 0,5m mit Aspöck DC-Stecksystem, 12V, 65x44x23 <i>End Outline Marker Lamp, FLEXIPOINT, Lens red/white, flex. bracket, cable 0,5m with Aspöck DC-Connector System, 65x44x23</i>		
15 597 601 Aspöck-Nr.: 15-5976-017	10	DC-Anschlußverbinder 12V inkl. 2 Verschlusskappen <i>DC-Connector System 12V</i>		

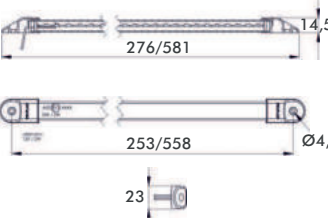
LED Begrenzungs-/Schluß-/Umrißleuchte

LED Position Lamp

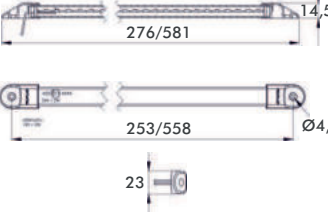
Typ: **PRO-STRIPE ECE**

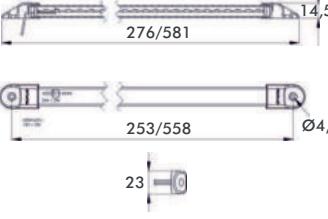

Artikel-Nr. Reference-No.	VE QTY	Beschreibung Description	LED Begrenzungs-/Schluß-/ Umrißleuchten LED Position Lamps	LED Technik LED Technology
40 052 002 24V	1	LED Schluß-/Umrißleuchte PRO-STRIPE ECE I , rot, Kabel 0,5m, wasserdichtes, vergossenes Leuchtgehäuse, IP6K9K, ADR-gepr., Anbau frei drehbar um die Bezugsachse, 276mm, 2W	 PRO-STRIPE ECE I 276mm	Leuchte in Funktion/Lamp in function   
40 052 202 12V	1	LED Position Lamp PRO-STRIPE ECE I red, incl.cable 0,5m, potted version, IP6K9K, ADR-appr., mounting free rotated about the reference axis, 276mm, 2W		
40 052 012 24V	1	LED Schluß-/Umrißleuchte PRO-STRIPE ECE II , rot, Kabel 0,5m, wasserdichtes, vergossenes Leuchtgehäuse, IP6K9K, ADR-gepr., Anbau frei drehbar um die Bezugsachse, 581mm, 4W	 PRO-STRIPE ECE II 581mm	
40 052 212 12V	1	LED Position Lamp PRO-STRIPE ECE II red, incl.cable 0,5m, potted version, IP6K9K, ADR-appr., mounting free rotated about the reference axis, 581mm, 4W		
40 052 003 24V	1	LED Begrenzungsleuchte PRO-STRIPE ECE I , weiß, Kabel 0,5m, wasserdichtes, vergossenes Leuchtgehäuse, IP6K9K, ADR-gepr., Anbau frei drehbar um die Bezugsachse, 276mm, 2W	 PRO-STRIPE ECE I 276mm	Leuchte in Funktion/Lamp in function   
40 052 203 12V	1	LED Position Lamp PRO-STRIPE ECE I white, incl.cable 0,5m, potted version, IP6K9K, ADR-appr., mounting free rotated about the reference axis, 276mm, 2W		
40 052 013 24V	1	LED Begrenzungsleuchte PRO-STRIPE ECE II , weiß, Kabel 0,5m, wasserdichtes, vergossenes Leuchtgehäuse, IP6K9K, ADR-gepr., Anbau frei drehbar um die Bezugsachse, 581m, 4W	 PRO-STRIPE ECE II 581mm	
40 052 213 12V	1	LED Position Lamp PRO-STRIPE ECE II white, incl.cable 0,5m, potted version, IP6K9K, ADR-appr., mounting free rotated about the reference axis, 581mm, 4W		
40 048 200	1	Befestigungskit PRO-STRIPE ECE inkl. Schrauben Mounting Kit PRO-STRIPE ECE incl. screws	 40 48 200	

LED Begrenzungs-/Schluß-/Umrißleuchte

LED Position Lamp

Typ: PRO-CAN XL

Artikel-Nr. Reference-No.	VE QTY	Beschreibung Description	LED Begrenzungs-/Schluß-/ Umrißleuchten LED Position Lamps	LED Technik LED Technology
40 026 092 24V	2	LED Schluß-/Umrißleuchte PRO-CAN XL Lichtleitertechnik, rot, Kabel 0,5m, wasserdichtes, vergossenes Leuchtgehäuse, Anbau horizontal oder vertikal	 Lichtleitertechnik/ Light guide technology	24V / 0,8W - 12V / 1,5W Leuchte in Funktion/Lamp in function 
40 026 292 12V	2	LED Position Lamp PRO-CAN XL Light guide technology, red, incl.cable 0,5m, potted version, for horizontal or vertical fixation		
40 026 002 24V	2	LED Schluß-/Umrißleuchte PRO-CAN XL rot, Kabel 0,5m, wasserdichtes, vergossenes Leuchtgehäuse, Anbau horizontal oder vertikal	 18 LEDs	 252 230 22
40 026 202 12V	2	LED Position Lamp PRO-CAN XL red, incl.cable 0,5m, potted version, for horizontal or vertical fixation		 18
40 026 093 24V	2	LED Begrenzungsleuchte PRO-CAN XL Lichtleitertechnik, weiß, Kabel 0,5m, wasserdichtes, vergossenes Leuchtgehäuse, Anbau horizontal oder vertikal	 Lichtleitertechnik/ Light guide technology	24V / 0,8W - 12V / 1,5W Leuchte in Funktion/Lamp in function 
40 026 293 12V	2	LED Position Lamp PRO-CAN XL Light guide technology, white, incl.cable 0,5m, potted version, for horizontal or vertical fixation		
40 026 003 24V	2	LED Begrenzungsleuchte PRO-CAN XL weiß, Kabel 0,5m, wasserdichtes, vergossenes Leuchtgehäuse, Anbau horizontal oder vertikal	 18 LEDs	 252 230 22
40 026 203 12V	2	LED Position Lamp PRO-CAN XL white, incl.cable 0,5m, potted version, for horizontal or vertical fixation		 18
20 017 102	10	Rückstrahler PRO-CAN rot mit Selbstklebefolie Reflex reflector PRO-CAN red		 22 70 5,5
20 017 103	10	Rückstrahler PRO-CAN weiß mit Selbstklebefolie Reflex reflector PRO-CAN white		
40 026 314	2	Winkelhalter für Leuchten- serie PRO-CAN XL Bracket 90° for lamp serie PRO-CAN XL		 55 230 256

LED Begrenzungs-/Schluß-/Umrißbleuchte

LED Position Lamp

Typ: PRO-CAN

Artikel-Nr. Reference-No.	VE QTY	Beschreibung Description	LED Begrenzungs-/Schluß-/ Umrißbleuchten LED Position Lamps	LED Technik LED Technology
40 017 022 24V	2	LED Schluß-/Umrißbleuchte PRO-CAN rot, Chrom Gehäuse, Kabel 0,5m, wasserdichtes, vergossenes Leuchtengehäuse <i>LED Position Lamp PRO-CAN red, chrome housing, incl. cable 0,5m, potted version</i>		24V / 0,8W
40 017 023 24V	2	LED Begrenzungsleuchte PRO-CAN weiß, Chrom Gehäuse Kabel 0,5m, wasserdichtes, vergossenes Leuchtengehäuse <i>LED Position Lamp PRO-CAN white, chrome housing, incl. cable 0,5m, potted version</i>		24V / 0,8W
40 017 002 24V	2	LED Schluß-/Umrißbleuchte PRO-CAN rot, Kabel 0,5m, wasserdichtes, vergossenes Leuchtengehäuse <i>LED Position Lamp PRO-CAN red, incl. cable 0,5m, potted version</i>		24V / 0,8W - 12V / 0,4W
40 017 202 12V	2	LED Schluß-/Umrißbleuchte PRO-CAN rot, Kabel 0,5m, wasserdichtes, vergossenes Leuchtengehäuse <i>LED Position Lamp PRO-CAN red, incl. cable 0,5m, potted version</i>		24V / 0,8W - 12V / 0,4W
40 017 003 24V	2	LED Begrenzungsleuchte PRO-CAN weiß, Kabel 0,5m, wasserdichtes, vergossenes Leuchtengehäuse <i>LED Position Lamp PRO-CAN white, incl. cable 0,5m, potted version</i>		24V / 0,8W - 12V / 0,4W
40 017 203 12V	2	LED Begrenzungsleuchte PRO-CAN weiß, Kabel 0,5m, wasserdichtes, vergossenes Leuchtengehäuse <i>LED Position Lamp PRO-CAN white, incl. cable 0,5m, potted version</i>		24V / 0,8W - 12V / 0,4W
20 017 102	10	Rückstrahler PRO-CAN rot mit Selbstklebefolie <i>Reflex reflector PRO-CAN red</i>		
20 017 103	10	Rückstrahler PRO-CAN weiß mit Selbstklebefolie <i>Reflex reflector PRO-CAN white</i>		

LED Begrenzungs-/Schluß-/Umrißbleuchte

LED Position Lamp

Typ: PRO-SLIM

Artikel-Nr. Reference-No.	VE QTY	Beschreibung Description	LED Begrenzungs-/Schluß-/ Umrißbleuchten LED Position Lamps	LED Technik LED Technology
40 044 002 24V	2	LED Schluß-/Umrißbleuchte PRO-SLIM rot, Kabel 0,5m, wasserdichtes, vergossenes Leuchtgehäuse, ARD geprüft		12V - 0,45W / 24V - 0,9W
40 044 202 12V	2	LED Position Lamp PRO-SLIM red, cable 0,5m, potted version, ADR appr.		
40 044 502 24V	2	LED Schluß-/Umrißbleuchte PRO-SLIM rot, Kabel 5,0m, wasserdichtes, vergossenes Leuchtgehäuse, ADR gerüft		
40 044 003 24V	2	LED Begrenzungsleuchte PRO-SLIM weiß, Kabel 0,5m, wasserdichtes, vergossenes Leuchtgehäuse, ADR gerüft		12V - 0,45W / 24V - 0,75W
40 044 203 12V	2	LED Position Lamp PRO-SLIM white, cable 0,5m, potted version, ADR appr.		
40 044 503 24V	2	LED Begrenzungsleuchte PRO-SLIM weiß, Kabel 5,0m, wasserdichtes, vergossenes Leuchtgehäuse, ADR gerüft		
40 044 402 12V	2	LED Schluß-/Umrißbleuchte PRO-SLIM rot, Flachkabel 0,5m, wasserdichtes, vergossenes Leuchtgehäuse, ADR gerüft		12V - 0,45W
40 044 403 12V	2	LED Begrenzungsleuchte PRO-SLIM weiß, Flachkabel 0,5m, wasserdichtes, vergossenes Leuchtgehäuse, ADR gerüft		
		LED Position Lamp PRO-SLIM red, flatcable 0,5m, potted version, ADR appr.		
		LED Position Lamp PRO-SLIM white, flatcable 0,5m, potted version, ADR appr.		12V - 0,45W
				

LED Begrenzungs-/Schluß-/Umrißleuchte

LED Position Lamp







Typ: PRO-FLAT

Artikel-Nr. Reference-No.	VE QTY	Beschreibung Description	LED Begrenzungs-/Schluß-/ Umrißleuchten LED Position Lamps	LED Technik LED Technology
40 061 002	2	<p>LED Schluß-/Umrißleuchte PRO-FLAT rot, Kabel 0,25m, wasserdichtes, vergossenes Leuchtgehäuse, 3M Selbstklebefolie für Schnellmontage oder alternativ Schraubbefestigung, EMV geprüft, 12V/24V</p> <p><i>LED Position Lamp PRO-FLAT red, incl. cable 0,25m, potted version, adhesive pad for quick fixation, alternatively screw fixation, EMC approved, 12V/24V</i></p>		
40 061 003	2	<p>LED Begrenzungsleuchte PRO-FLAT weiß, Kabel 0,25m, wasserdichtes, vergossenes Leuchtgehäuse, 3M Selbstklebefolie für Schnellmontage oder alternativ Schraubbefestigung, EMV geprüft, 12V/24V</p> <p><i>LED Position Lamp PRO-FLAT white, incl. cable 0,25m, potted version, adhesive pad for quick fixation, alternatively screw fixation, EMC approved, 12V/24V</i></p>		
40 061 022	2	<p>LED Schluß-/Umrißleuchte PRO-FLAT „Color Edition“ rot, Kabel 0,25m, wasserdichtes, vergossenes Leuchtgehäuse, 3M Selbstklebefolie für Schnellmontage oder alternativ Schraubbefestigung, EMV geprüft, 12V/24V</p> <p><i>LED Position Lamp PRO-FLAT „Color Edition“, red, cable 0,25m, potted version, adhesive pad for quick fixation, alternatively screw fixation, EMC approved, 12V/24V</i></p>		
40 061 033	2	<p>LED Begrenzungsleuchte PRO-FLAT „Color Edition“ weiß, Kabel 0,25m, wasserdichtes, vergossenes Leuchtgehäuse, 3M Selbstklebefolie für Schnellmontage oder alternativ Schraubbefestigung, EMV geprüft, 12V/24V</p> <p><i>LED Position Lamp PRO-FLAT „Color Edition“, white, cable 0,25m, potted version, adhesive pad for quick fixation, alternatively screw fixation, EMC approved, 12V/24V</i></p>		

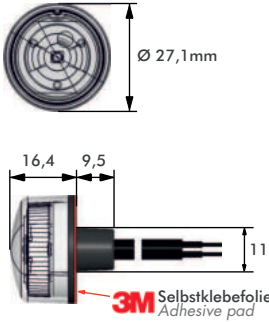
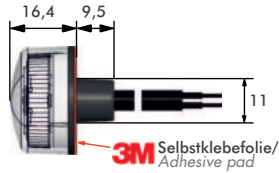
LED Begrenzungs-/Schluß-/Umrißleuchte

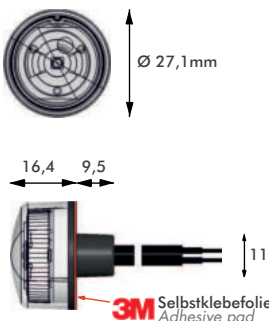
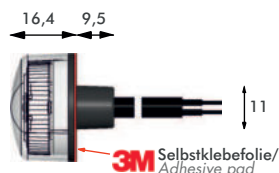
LED Position Lamp

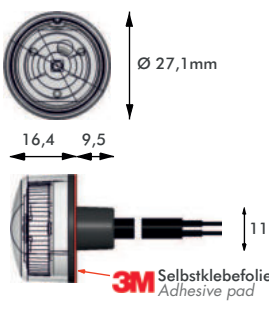
Typ: PRO-PENNY

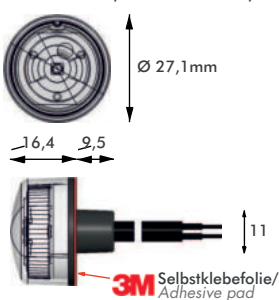









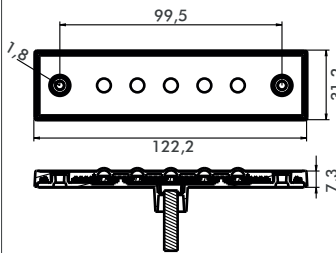

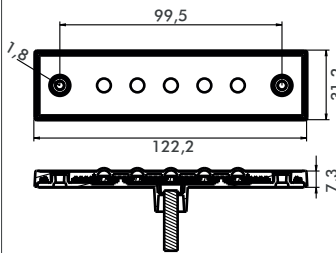
Artikel-Nr. Reference-No.	VE QTY	Beschreibung Description	LED Begrenzungs-/Schluß-/ Umrißleuchten LED Position Lamps	LED Technik LED Technology
40 002 002	2	LED Schluß-/Umrißleuchte PRO-PENNY rot, Kabel 0,5m, wasserdichtes, vergossenes Leuchtgehäuse, sichere Befestigung mit 3M Selbstklebefolie, 12V/24V, ADR geprüft <i>LED Position Lamp PRO-PENNY red, incl. cable 0,5m, potted version, safely fixation with 3M adhesive pad 12V/24V, ADR appr.</i>		12V - 1,0W / 24V - 1,5W 
40 002 502	2	LED Schluß-/Umrißleuchte PRO-PENNY dito, Kabel 5,0m <i>LED Position Lamp PRO-PENNY with cable 5,0m</i>		
40 002 003	2	LED Begrenzungsleuchte PRO-PENNY weiß, Kabel 0,5m, wasserdichtes, vergossenes Leuchtgehäuse, sichere Befestigung mit 3M Selbstklebefolie, 12V/24V, ADR geprüft <i>LED Position Lamp PRO-PENNY white, incl. cable 0,5m, potted version, safely fixation with 3M adhesive pad, 12V/24V, ADR appr.</i>		12V - 1,0W / 24V - 1,5W 
40 002 503	2	LED Begrenzungsleuchte PRO-PENNY dito, Kabel 5,0m <i>LED Position Lamp PRO-PENNY with cable 5,0m</i>		
40 002 402	2	LED Schluß-/Umrißleuchte PRO-PENNY rot, Flachkabel 0,5m, wasserdichtes, vergossenes Leuchtgehäuse, sichere Befestigung mit 3M Selbstklebefolie, 12V/24V, ADR geprüft <i>LED Position Lamp PRO-PENNY red, incl. flatcable 0,5m, potted version, safely fixation with 3M adhesive pad, 12V/24V, ADR-appr.</i>		12V - 1,0W / 24V - 1,5W 
40 002 403	2	LED Begrenzungsleuchte PRO-PENNY weiß, Flachkabel 0,5m, wasserdichtes, vergossenes Leuchtgehäuse, sichere Befestigung mit 3M Selbstklebefolie, 12V/24V, ADR geprüft <i>LED Position Lamp PRO-PENNY white, incl. flatcable 0,5m, potted version, safely fixation with 3M adhesive pad, 12V/24V, ADR-appr.</i>		12V - 1,0W / 24V - 1,5W 

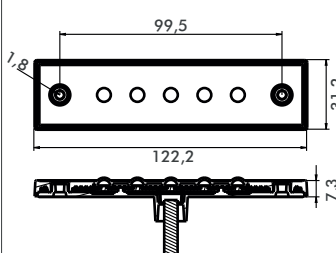
LED Begrenzungs-/Schluß-/Umrißleuchte

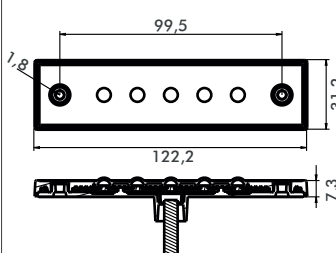
LED Position Lamp

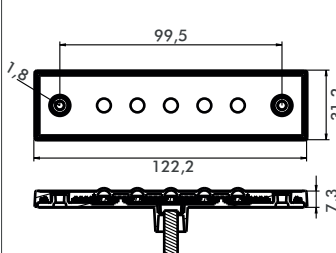
Typ: PRO-SUPER-FLAT

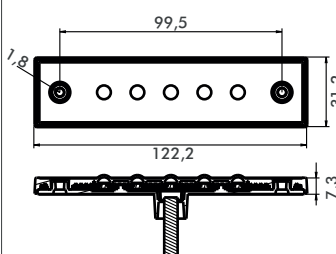

Artikel-Nr. Reference-No.	VE QTY	Beschreibung Description	LED Begrenzungs-/Schluß-/ Umrißleuchten LED Position Lamps	LED Technik LED Technology
40 063 002	2	LED Schluß-/Umrißleuchte PRO-SUPER-FLAT rot, Anbaulage horizontal oder vertikal, wasserdicht vergossenes Gehäuse, Kabel 0,5m, 12/24 Volt, EMV & ADR geprüft IP6K9K <i>LED Position Lamp PRO-SUPER-FLAT red, fixation horizontal or vertical, waterproof casted, cable 0,5m 12/24 Volt, EMC & ADR appr. IP6K9K</i>		
40 063 012	2	LED Schluß-/Umrißleuchte PRO-SUPER-FLAT , dito, 3M Selbstklebefolie für Schnellmontage <i>LED Position Lamp PRO-SUPER-FLAT 3M adhesive pad for quick fixation</i>		
40 063 003	2	LED Begrenzungsleuchte PRO-SUPER-FLAT weiß, Anbaulage horizontal oder vertikal, wasserdicht vergossenes Gehäuse, Kabel 0,5m, 12/24 Volt, EMV & ADR geprüft IP6K9K <i>LED Position Lamp PRO-SUPER-FLAT white, fixation horizontal or vertical, waterproof casted, cable 0,5m 12/24 Volt, EMC & ADR appr. IP6K9K</i>		
40 063 013	2	LED Schluß-/Umrißleuchte PRO-SUPER-FLAT , dito, 3M Selbstklebefolie für Schnellmontage <i>LED Position Lamp PRO-SUPER-FLAT 3M adhesive pad for quick fixation</i>		
40 063 602	2	LED Schluß-/Umrißleuchte PRO-SUPER-FLAT rot, Anbaulage horizontal oder vertikal, wasserdicht vergossenes Gehäuse, Kabel 0,5m + P&R Stecker, 12/24V, EMV & ADR geprüft IP6K9K <i>LED Position Lamp PRO-SUPER-FLAT red, fixation horizontal or vertical, waterproof casted, cable 0,5m + P&R connector, 12/24 Volt, EMC & ADR appr. IP6K9K</i>		
40 063 603	2	LED Begrenzungsleuchte PRO-SUPER-FLAT weiß, Anbaulage horizontal oder vertikal, wasserdicht vergossenes Gehäuse, Kabel 0,5m + P&R Stecker, 12/24V, EMV & ADR geprüft IP6K9K <i>LED Position Lamp PRO-SUPER-FLAT white, fixation horizontal or vertical, waterproof casted, cable 0,5m + P&R connector, 12/24 Volt, EMC & ADR appr. IP6K9K</i>		

LED Begrenzungs-/Schluß-/Umrißleuchte

LED Position Lamp

Typ: **PRO-SUPER-FLAT**



Artikel-Nr. Reference-No.	VE QTY	Beschreibung Description	LED Begrenzungs-/Schluß-/ Umrißleuchten LED Position Lamps	LED Technik LED Technology
40 063 202	2	<p>LED Schluß-/Umrißleuchte PRO-SUPER-FLAT rot, Anbaulage horizontal oder vertikal, wasserdicht vergossenes Gehäuse, Flachkabel 0,5m, 12/24 Volt, EMV & ADR geprüft IP6K9K</p> <p><i>LED Position Lamp PRO-SUPER-FLAT red, fixation horizontal or vertical, waterproof casted, flatcable 0,5m 12/24 Volt, EMC & ADR appr. IP6K9K</i></p>		
40 063 203	2	<p>LED Begrenzungsleuchte PRO-SUPER-FLAT weiß, Anbaulage horizontal oder vertikal, wasserdicht vergossenes Gehäuse, Flachkabel 0,5m, 12/24 Volt, EMV & ADR geprüft IP6K9K</p> <p><i>LED Position Lamp PRO-SUPER-FLAT white, fixation horizontal or vertical, waterproof casted, flatcable 0,5m 12/24 Volt, EMC & ADR appr. IP6K9K</i></p>		
40 063 072	2	<p>LED Schluß-/Umrißleuchte PRO-SUPER-FLAT rot, Anbaulage horizontal oder vertikal, wasserdicht vergossenes Gehäuse, AMP SuperSeal Stecker, 12/24 Volt, EMV & ADR geprüft IP6K9K</p> <p><i>LED Position Lamp PRO-SUPER-FLAT red, fixation horizontal or vertical, waterproof casted, AMP SuperSeal connector, 12/24 Volt, EMC & ADR appr. IP6K9K</i></p>		
40 063 073	2	<p>LED Begrenzungsleuchte PRO-SUPER-FLAT weiß, Anbaulage horizontal oder vertikal, wasserdicht vergossenes Gehäuse, AMP SuperSeal Stecker, 12/24 Volt, EMV & ADR geprüft IP6K9K</p> <p><i>LED Position Lamp PRO-SUPER-FLAT white, fixation horizontal or vertical, waterproof casted, AMP SuperSeal connector, 12/24 Volt, EMC & ADR appr. IP6K9K</i></p>		

LED Begrenzungs-/Schluß-/Umrißleuchte

LED Position Lamp

Typ: PRO-BUTTON

Artikel-Nr. Reference-No.	VE QTY	Beschreibung Description	LED Begrenzungs-/Schluß-/ Umrißleuchten LED Position Lamps	LED Technik LED Technology
40 065 002	2	LED Schluß-/Umrißleuchte PRO-BUTTON rot, wasserdicht vergossenes Gehäuse, Kabel 0,5m, 12/24 Volt, EMV & ADR geprüft IP6K9K <i>LED Position Lamp PRO-BUTTON red, waterproof casted, cable 0,5m 12/24 Volt, EMC & ADR appr. IP6K9K</i>		
40 065 012	2	LED Schluß-/Umrißleuchte PRO-BUTTON , dito, 3M Selbstklebefolie für Schnellmontage <i>LED Position Lamp PRO-BUTTON 3M adhesive pad for quick fixation</i>		
40 065 003	2	LED Begrenzungsleuchte PRO-BUTTON weiß, wasserdicht vergossenes Gehäuse, Kabel 0,5m, 12/24 Volt, EMV & ADR geprüft IP6K9K <i>LED Position Lamp PRO-BUTTON white, waterproof casted, cable 0,5m, 12/24 Volt, EMC & ADR appr. IP6K9K</i>		
40 065 013	2	LED Schluß-/Umrißleuchte PRO-BUTTON , dito, 3M Selbstklebefolie für Schnellmontage <i>LED Position Lamp PRO-BUTTON 3M adhesive pad for quick fixation</i>		
40 065 202	2	LED Schluß-/Umrißleuchte PRO-BUTTON rot, wasserdicht vergossenes Gehäuse, Flachkabel 0,5m, 12/24 Volt, EMV & ADR geprüft IP6K9K <i>LED Position Lamp PRO-BUTTON red, waterproof casted, flatcable 0,5m 12/24 Volt, EMC & ADR appr. IP6K9K</i>		
40 065 203	2	LED Begrenzungsleuchte PRO-BUTTON weiß, wasserdicht vergossenes Gehäuse, Flachkabel 0,5m, 12/24 Volt, EMV & ADR geprüft IP6K9K <i>LED Position Lamp PRO-BUTTON white, waterproof casted, flatcable 0,5m, 12/24 Volt, EMC & ADR appr. IP6K9K</i>		

LED Begrenzungs-/Schluß-/Umrißleuchte

LED Position Lamp

Typ: PRO-REP Hotmelt Technik

Artikel-Nr. Reference-No.	VE QTY	Beschreibung Description	LED Begrenzungs-/Schluß-/ Umrißleuchten LED Position Lamps	LED Technik LED Technology
40 015 502 24V	2	LED Schluß-/Umrißleuchte rot, 90°-Kabelanschluß im Hotmelt- Verfahren, Kabel 0,5m <i>LED Position Lamp red, 90°-cable connection, cable 0,5m</i>		
40 015 202 12V	2			
40 015 513 24V	2	LED Begrenzungsleuchte weiß, 90°-Kabelanschluß im Hotmelt- Verfahren, Kabel 0,5m <i>LED Position Lamp white, 90°-cable connection, cable 0,5m</i>		
40 015 213 12V	2			
40 015 602 24V	2	LED Schluß-/Umrißleuchte rot, 90°-Kabelanschluß im Hotmelt- Verfahren, Kabel 0,5m mit P&R Stecker <i>LED Position Lamp red, 90°- cable connection, cable 0,5m, w. P&R connector</i>		
40 015 613 24V	2	LED Begrenzungsleuchte weiß, 90°-Kabelanschluß im Hotmelt- Verfahren, Kabel 0,5m mit P&R Stecker <i>LED Position Lamp white, 90°- cable connection, cable 0,5m, w. P&R connector</i>		
40 015 243 12V	2	LED Begrenzungsleuchte weiß, 90°-Kabelanschluß im Hotmelt- Verfahren, DC-Flachkabel 0,5m <i>LED Position Lamp white, 90°-cable connection, DC-flatcable 0,5m</i>		
40 157 314	10	Winkelhalter für LED Begrenzungsleuchte <i>90°-Bracket for LED Position Lamp</i>		
15 597 101	10	Verschlußskappen für Aspöck P&R Stecker, grau <i>Caps for Aspöck P&R connector, grey</i>		
			40 157 314	15 597 101

LED Begrenzungs-/Schluß-/Umrißleuchte

LED Position Lamp



Artikel-Nr. Reference-No.	VE QTY	Beschreibung Description	LED Begrenzungs-/Schluß-/ Umrißleuchten mit Rückstrahler LED Position Lamps with Reflex Reflector	LED Technik LED Technology
40 197 513 24V	2	LED Begrenzungsleuchte weiß, 90°-Kabelanschluß im Hotmelt- Verfahren, Kabel 0,5m, 24V/1W <i>LED Position Lamp white, 90°-cable connection, cable 0,5m, 24V/1W</i>		
40 197 213 12V	2	LED Begrenzungsleuchte weiß, 90°-Kabelanschluß im Hotmelt- Verfahren, Kabel 0,5m, 12V/1W <i>LED Position Lamp white, 90°-cable connection, cable 0,5m, 12V/1W</i>		
40 197 512 24V	2	LED Schluß-/Umrißleuchte rot mit Rückstrahler, 90°-Kabelanschluß im Hotmelt- Verfahren, Kabel 0,5m, 24V/1W <i>LED Position Lamp red with reflex reflector, 90°-cable connection, cable 0,5m, 24V/1W</i>		
50 080 000	1	50m ADR-Rundleitung FLRYY 2x1,0 für Begrenzungsleuchten <i>50m ADR-Cable round, FLRYY 2 X 1,0 for Position lamps</i>	 50 080 000	

LED Begrenzungs-/Schluß-/Umrißbleuchte

LED Position Lamp











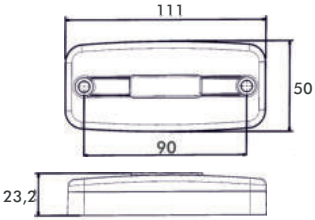

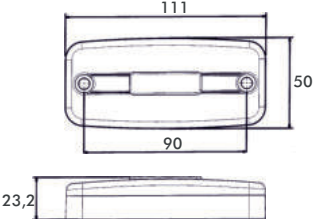
Artikel-Nr. Reference-No.	VE QTY	Beschreibung Description	LED Begrenzungs-/Schluß-/ Umrißbleuchten LED Position Lamps	LED Technik 24V / 0,8W LED Technology 24V / 0,8W
40 163 502	2	LED Schluß-/Umrißleuchte rot, 90°-Kabelanschluß im Hotmelt- Verfahren, Kabel 0,5m, 24V/0,8W <i>LED Position Lamp red, 90°-cable connection, cable 0,5m, 24V/0,8W</i>		
40 164 513	2	LED Begrenzungsleuchte weiß, 90°-Kabelanschluß im Hotmelt- Verfahren, Kabel 0,5m, 24V/0,8W <i>LED Position Lamp white, 90°-cable connection, cable 0,5m, 24V/0,8W</i>		
40 164 523	2	LED Begrenzungsleuchte weiß, dito., gerader Kabelanschluß <i>LED Position Lamp white, straight-cable connection</i>	 40 164 513 40 164 523	 40 164 513 40 164 523
40 163 602	2	LED Schluß-/Umrißleuchte rot, 90°-Kabelanschluß im Hotmelt- Verfahren, Kabel 0,5m mit P&R Stecker, 24V/0,8W <i>LED Position Lamp red, 90°- cable connection, cable 0,5m, w. P&R connector, 24V/0,8W</i>		
50 081 200	1	PU-Flachkabel 200m für Aspöck P&R Steckersystem <i>PU-Flat-Cable 200m for Aspöck P&R connector system</i>		
40 157 314	10	Winkelhalter für LED Begrenzungsleuchte <i>90°-Bracket for LED Position Lamp</i>	 50 081 200	 40 157 314
40 128 254	10	Flex. Gummiunterlage <i>Flex. Support</i>		
40 163 000	10	Aufbaugehäuse 33mm <i>Plastic Support 33mm</i>	 40 128 254	 40 163 000

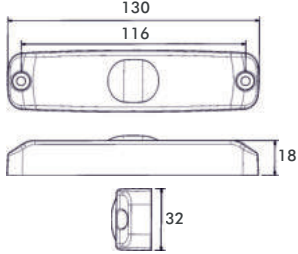
LED Begrenzungs-/Schluß-/Umrißleuchte

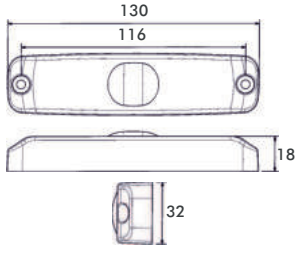
LED Position Lamp

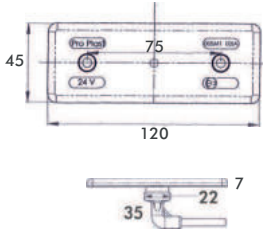









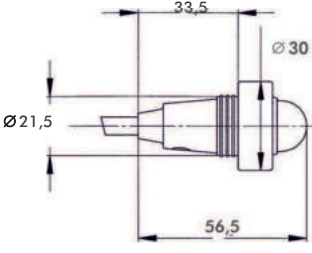

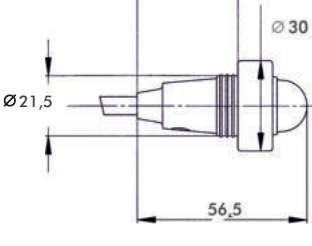
Artikel-Nr. Reference-No.	VE QTY	Beschreibung Description	LED Begrenzungs-/Schluß-/ Umrißleuchten LED Position Lamps	LED Technik 24V / 1W LED Technology 24V / 1W
40 120 002	1	LED Schluß-/Umrißleuchte rot mit Rückstrahler, wasserdichtes Gehäuse inkl. Kabel 0,5m, 12/24V <i>LED Position Lamp red w. Reflex Reflector, waterproofed housing incl. cable 0,5m, 12/24V</i>		
40 120 003	1	LED Begrenzungsleuchte weiß mit Rückstrahler, wasserdichtes Gehäuse inkl. Kabel 0,5m, 12/24V <i>LED Position Lamp white w. Reflex Reflector, waterproofed housing incl. cable 0,5m, 12/24V</i>		
40 023 902	2	LED Schluß-/Umrißleuchte rot mit Rückstrahler, wasserdichtes Gehäuse inkl. Kabel 0,5m, 12/24V, ADR geprüft <i>LED Position Lamp red w. Reflex Reflector, waterproofed housing incl. cable 0,5m, 12/24V, ADR approved</i>		
40 023 903	2	LED Begrenzungsleuchte weiß mit Rückstrahler, wasserdichtes Gehäuse inkl. Kabel 0,5m, 12/24V, ADR geprüft <i>LED Position Lamp white w. Reflex Reflector, waterproofed housing incl. cable 0,5m, 12/24V, ADR approved</i>		
40 194 003	2	LED Begrenzungsleuchte weiß, 90°-Kabelanschluß im Hotmelt-Verfahren, Kabel 0,5m, 24V/1W <i>LED Position Lamp white, 90°-cable connection, cable 0,5m, 24V/1W</i>		
40 194 314	10	Winkelhalter für LED Begrenzungsleuchte <i>90°-Bracket for LED Position Lamp</i>	 40 194 314	

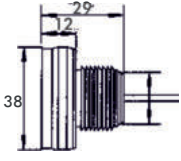
LED Begrenzungs-/Schluß-/Umrißbleuchte

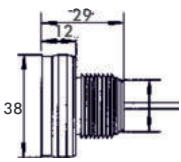
LED Position Lamp

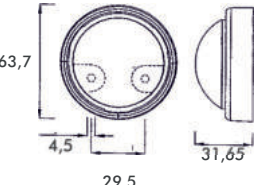
 Typ: **MONOPOINT, Universal**

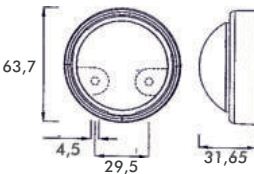
Artikel-Nr. Reference-No.	VE QTY	Beschreibung Description	LED Begrenzungs-/Schluß-/ Umrißbleuchten LED Position Lamps	LED Technik LED Technology
40 185 002 24V	2	LED Schluß-/Umrißbleuchte, MONOPOINT I Lichtaustritt rot, komplett kunststoffummantelte, wasserdichte Leuchteneinheit inkl. ADR Kabel 2,0m, Befestigungsloch 21-22,5mm <i>LED Position Lamp MONOPOINT I red, complete plastic covered, waterproofed housing, incl. ADR cable 2,0m, fixation hole 21-22,5mm</i>	 Lichtaustritt rot Red Light	
40 185 003 24V	2	LED Begrenzungsleuchte, MONOPOINT I Lichtaustritt weiß, komplett kunststoffummantelte, wasserdichte Leuchteneinheit inkl. ADR Kabel 2,0m, Befestigungsloch 21-22,5mm <i>LED Position Lamp MONOPOINT I white, complete plastic covered, waterproofed housing, incl. ADR cable 2,0m, fixation hole 21-22,5mm</i>	 Lichtaustritt weiß White Light	
31 680 001 Aspöck-Nr.: 31-6800-017	1	LED Schluß-/Umrißbleuchte MONOPOINT II rot, flache Ausführung, Kabel 3,5m , 12/24V <i>LED Position Lamp MONOPOINT II red, flat version, cable 3,5m , 12/24V</i>		 Befestigungsloch/Fixation Hole: 21mm
31 670 002 Aspöck-Nr.: 31-6700-027	1	LED Begrenzungsleuchte MONOPOINT II weiß, flache Ausführung, Kabel 3,5m , 12/24V <i>LED Position Lamp MONOPOINT II white, flat version, cable 3,5m , 12/24V</i>		 Befestigungsloch/Fixation Hole: 21mm
40 020 002	2	LED Schluß-/Umrißbleuchte rot, wasserdichtes Gehäuse, Kabel 0,3m, 9-36V <i>LED Position Lamp red, waterproofed housing, cable 0,3m, 9-36V</i>		
40 020 003	2	LED Begrenzungsleuchte weiß, wasserdichtes Gehäuse, Kabel 0,3m, 9-36V <i>LED Position Lamp white, waterproofed housing, cable 0,3m, 9-36V</i>		

LED Begrenzungs-/Schluß-/Umrißleuchte

LED Position Lamp









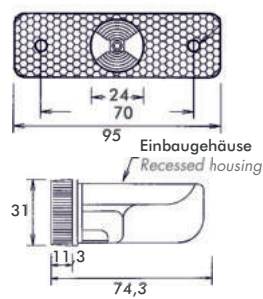

Typ: UNIPOINT, FLATPOINT II

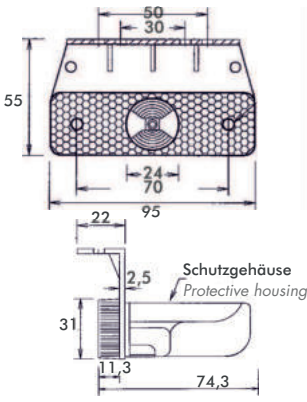
Artikel-Nr. Reference-No.	VE QTY	Beschreibung Description	LED Begrenzungs-/Schluß-/ Umrißleuchten LED Position Lamps	LED Technik 24V / 1,3W LED Technology 24V / 1,3W
31 770 401 Aspöck-Nr.: 31-7704-017	1	LED Begrenzungsleuchte Unipoint weiß mit Rückstrahler, Kabel 0,5m mit Aspöck P&R Stecker, 24V/1,3W <i>LED Position Lamp Unipoint white w. Reflex Reflector, cable 0,5m with Aspöck P&R connector, 24V/1,3W</i>		
31 770 403 Aspöck-Nr.: 31-7704-037	1	LED Begrenzungsleuchte Unipoint weiß mit Rückstrahler, Kabel 1,5m mit Aspöck P&R Stecker, 24V/1,3W <i>LED Position Lamp Unipoint white w. Reflex Reflector, cable 1,5m with Aspöck P&R connector, 24V/1,3W</i>		
31 780 401 Aspöck-Nr.: 31-7804-017	1	LED Schluß-/Umrißleuchte Unipoint rot mit Rückstrahler, Kabel 0,5m mit Aspöck P&R Stecker, 24V/1,3W <i>LED Position Lamp Unipoint red w. Reflex Reflector, cable 0,5m with Aspöck P&R connector, 24V/1,3W</i>		
31 690 401 Aspöck-Nr.: 31-6904-017	1	LED Begrenzungsleuchte FLATPOINT II weiß mit Rückstrahler, Kabel 0,5m mit Aspöck P&R Stecker, 24V/1,3W <i>LED Position Lamp FLATPOINT II white w. Reflex Reflector, cable 0,5m with Aspöck P&R connector, 24V/1,3W</i>		
68 500 001 Aspöck-Nr.: 68-5000-007	1	Anschlußkabel 0,5m mit Aspöck P&R Stecker <i>Cable 0,5m with Aspöck P&R connector</i>	 68 500 001	

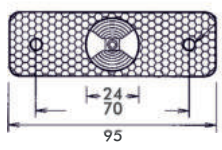
LED Begrenzungsleuchte

LED Position Lamp

Typ: FLATPOINT

Artikel-Nr. Reference-No.	VE QTY	Beschreibung Description	LED Begrenzungsleuchten LED Position Lamps	LED Technik 24V / 1,3W LED Technology 24V / 1,3W
21 660 100 Aspöck-Nr.: 21-6601-004	1	LED Begrenzungsleuchte FLATPOINT weiß mit Einbau- gehäuse, Bajonettanschluß mit Gummitülle 90°, 24V/1,3W <i>LED Position Lamp FLATPOINT, white incl. recessed housing, bayonet joint and grommet 90°, 24V/1,3W</i>		
21 660 000 Aspöck-Nr.: 21-6600-004	1	LED Begrenzungsleuchte FLATPOINT weiß mit Schutz- gehäuse, Bajonettanschluß mit Gummitülle 90°, 24V/1,3W, Winkelhalter 90° <i>LED Position Lamp FLATPOINT, white incl. protective housing, bayonet joint and grommet 90°, 24V/1,3W, fixation bracket 90°</i>		
31 660 409 Aspöck-Nr.: 31-6604-097	1	LED Begrenzungsleuchte FLATPOINT weiß mit Gummi- unterlage, Bajonettanschluß mit Gummitülle 90°, Kabel 1,5m mit Aspöck P&R Stecker 24V/1,3W <i>LED Position Lamp FLATPOINT, white incl. rubber support, bayonet joint and grommet 90°, cable 1,5m with Aspöck P&R connector, 24V/1,3W</i>		
21 660 001 Aspöck-Nr.: 21-6600-014	1	LED Lichtscheibe für BGL weiß <i>LED Lens for Position Lamp white</i>		
15 212 210 Aspöck-Nr.: 15-2122-104	1	Anschlußteilesatz für BGL <i>Connector Kit for Position Lamp</i>		
68 500 003 Aspöck-Nr.: 68-5000-037	1	LED Anschlußleitung 1,5m mit Aspöck P&R Stecker <i>Cable 1,5m with Aspöck P&R connector</i>		

LED Begrenzungs-/Schluß-/Umrißleuchte

LED Position Lamp

Typ: **POSIPOINT**







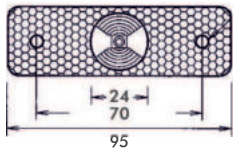

Artikel-Nr. Reference-No.	VE QTY	Beschreibung Description	LED Begrenzungs-/Schluß-/ Umrißleuchten LED Position Lamps	LED Technik LED Technology
31 620 408 Aspöck-Nr.: 31-6204-087	1	LED Schluß-/Umrißleuchte POSIPOINT , rot, Kabel 0,5m mit Aspöck P&R Stecker, 12/24V <i>LED Position Lamp POSIPOINT, red, incl. cable 0,5m with Aspöck P&R connector, 12/24V</i>		
31 600 407 Aspöck-Nr.: 31-6004-077	1	LED Begrenzungsleuchte POSIPOINT , weiß, Kabel 0,5m mit Aspöck P&R Stecker, 12/24V <i>LED Position Lamp POSIPOINT, white incl. cable 0,5m with Aspöck P&R connector, 12/24V</i>		
31 720 400	1	LED Schluß-/Umrißleuchte rot, Kabel 0,5m mit P&R Stecker, 12/24V <i>LED Position Lamp red, incl. cable 0,5m with P&R connector, 12/24V</i>	 Lichtaustritt rot <i>Red Light</i>	
31 710 400	1	LED Begrenzungsleuchte weiß, Kabel 0,5m mit P&R Stecker, 12/24V <i>LED Position Lamp white, incl. cable 0,5m with P&R connector, 12/24V</i>	 Lichtaustritt weiß <i>White Light</i>	

Begrenzungs-/Schluß-/Umrißleuchte

Position Lamp

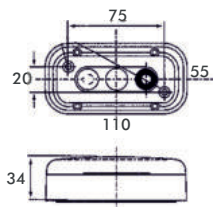

Artikel-Nr. Reference-No.	VE QTY	Beschreibung Description	Begrenzungs-/Schluß-/ Umrißleuchten Position Lamps	BA 9s / T4W
40 133 003	10	Begrenzungsleuchte weiß mit Rückstrahler, Fassungsgehäuse mit Bajonettverschluß inkl. Glühlampe 24V/4W, Winkeltülle 12V/24V <i>Position Lamp white, w. reflector, bulbholder w. bayonet joint incl. bulb 24V/4W, 90° grommet, 12V/24V</i>		
40 133 103	10	Lichtscheibe für Begrenzungsleuchte weiß <i>Lens white for position lamp</i>		
40 128 254	10	Lichtscheibe für Begrenzungsleuchte weiß <i>Lens white for position lamp</i>	40 133 103	40 128 254
40 128 204	10	Fassungsgehäuse inkl. Glühlampe für Begrenzungsleuchte weiß <i>Bulbholder incl. bulb for position lamp</i>		
68 500 001	10	Anschlußleitung 0,5m mit Aspöck P&R Stecker <i>Cable 0,5m with Aspöck P&R connector</i>	40 128 204	68 500 001
40 123 013	8	Begrenzungsleuchte weiß mit Rückstrahler, Dichtungsgummi zwischen Lichtscheibe und Gehäuse, 1 St.PG-Verschraubung, 12V/24V <i>Position Lamp white with reflex reflector, rubber seal between lens and housing, 1 pcs. PG-Screw, 12V/24V</i>		





Begrenzungs-/Schluß-/Umrißleuchte

Position Lamp

Artikel-Nr. Reference-No.	VE QTY	Beschreibung Description	Begrenzungs-/Schluß-/ Umrißleuchten Position Lamps	SV 8,5 / C5W
40 138 002	10	Schluß-/Umrißleuchte rot, Dichtungsgummi zwischen Lichtscheibe und Gehäuse, 12V/24V <i>Position Lamp red, rubber seal between lens and housing, 12V/24V</i>		
40 138 003	10	Begrenzungsleuchte weiß, Dichtungsgummi zwischen Lichtscheibe und Gehäuse, 12V/24V <i>Position Lamp white, rubber seal between lens and housing, 12V/24V</i>		
40 134 003	10	Begrenzungsleuchte weiß mit Rückstrahler, 12V/24V <i>Position Lamp white with reflex reflector, 12V/24V</i>		
40 147 003	10	Einbau Begrenzungsleuchte weiß im Gummigehäuse, 12V/24V <i>Recessed Position Lamp white, rubber housing, 12V/24V</i>		
31 650 902 Aspöck-Nr.: 31-6509-027	10	Begrenzungsleuchte FLEXIPOINT Lichtscheibe weiß mit Rückstr., Kabel 0,5m mit Aspöck DC-Stecksystem, 12V, 65x44x23 <i>Position Lamp FLEXIPOINT, Lens white with reflex reflector, cable 0,5m with Aspöck DC-Connector System, 65x44x23</i>		
18 816 502 Aspöck-Nr.: 18-8165-027	10	Lichtscheibe weiß für FLEXIPOINT Begrenzungsleuchte <i>Lens for Position Lamp FLEXIPOINT</i>		
15 597 601 Aspöck-Nr.: 15-5976-017	10	DC-Anschlußverbinder 12V inkl. 2 Verschlusskappen <i>DC-Connector System 12V</i>		

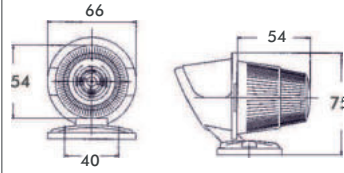
Positionsleuchte

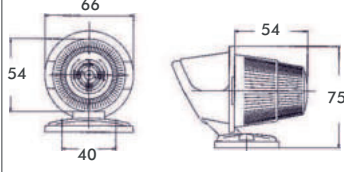
Position Lamp

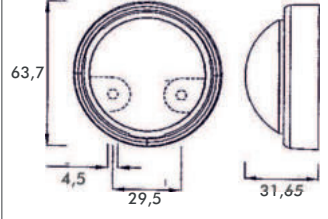
Artikel-Nr. Reference-No.	VE QTY	Beschreibung Description	Positionsleuchten Position Lamps	BA 15s / R5W
40 126 001	10	Positionsleuchte gelb, Dachaufbau, Gehäuse schwarz, 12V/24V <i>Position lamp amber, black housing, 12V/24V</i>		
40 126 003	10	Positionsleuchte weiß, Dachaufbau, Gehäuse schwarz, 12V/24V <i>Position lamp white, black housing, 12V/24V</i>		
40 020 001	2	LED Positions-/ Seitenmarkierungsleuchte gelb, wasserdichtes Gehäuse, Kabel 0,3m, 9-36V <i>LED Position-/Sidemarker Lamp amber, waterproofed housing, cable 0,3m, 9-36V</i>	 	

Artikel-Nr. <i>Reference-No.</i>	Notizen <i>Notes</i>

LED Seitenmarkierungsleuchten
Verkabelte
LED Seitenmarkierungsleuchten
Seitenmarkierungsleuchten

LED Sidemarker Lamps
LED Sidemarker Lamps with cable

4.0 - 4.25

Sidemarker Lamps

4.23 - 4.28











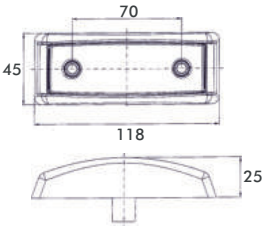

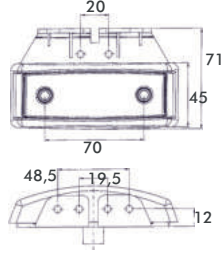

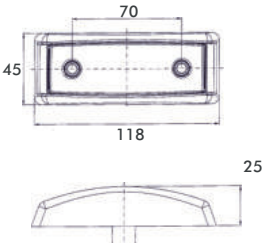
*straßentaug***LICHT**

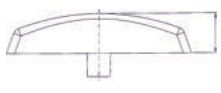
LED Seitenmarkierungsleuchte

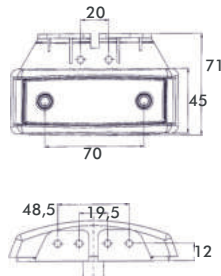
LED Sidemarker Lamp

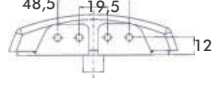
Typ: PRO-SML

Artikel-Nr. Reference-No.	VE QTY	Beschreibung Description	LED Seitenmarkierungs- leuchten LED Sidemarker Lamps	LED Technik LED Technology
40 049 001	2	LED Seitenmarkierungsleuchte PRO-SML , Kabel 0,5m, 10-32V/1,3W, IP6K9K, ADR gepr., SAE zugelassen <i>LED Sidemarker Lamp PRO-SML, cable 0,5m, 10-32V/1,3W IP6K9K, ADR approved, according to SAE</i>		
40 049 021	2	LED Seitenmarkierungsleuchte PRO-SML , Kabel 0,5m, 90° Winkelhalter, 10-32V/1,3W, IP6K9K, ADR gepr., SAE zugelassen <i>LED Sidemarker Lamp PRO-SML, cable 0,5m, bracket 90°, 10-32V/1,3W, IP6K9K, ADR approved, according to SAE</i>		
40 049 801	2	LED Seitenmarkierungsleuchte + seitliche Blinkleuchte Kat. 5, PRO-MULTI-SML , Kabel 0,5m, 10-32V/1,6W, IP6K9K, ADR gepr., SAE zugelassen <i>LED Sidemarker Lamp incl. lateral LED Direction Indicator Lamp cat. 5, PRO-MULTI-SML, cable 0,5m, 10-32V/1,6W, IP6K9K, ADR approved, according to SAE</i>		
40 049 501	2	LED Seitenmarkierungsleuchte + seitliche Blinkleuchte Kat. 5, PRO-MULTI-SML , dito., AMP Super Seal Steacker 3-polig <i>LED Sidemarker Lamp incl. lateral LED Direction Indicator Lamp cat. 5, PRO-MULTI-SML, AMP SS con. 3-pol.</i>	 Kategorie 5 + LED SML	
40 049 821	2	LED Seitenmarkierungsleuchte + seitliche Blinkleuchte Kat. 5, PRO-MULTI-SML , Kabel 0,5m, 90° Winkelhalter, 10-32V/1,6W, IP6K9K, ADR gepr., SAE zugelassen <i>LED Sidemarker Lamp incl. lateral LED Direction Indicator Lamp cat. 5, PRO-MULTI-SML, cable 0,5m, bracket 90°, 10-32V/1,6W, IP6K9K, ADR approved, according to SAE</i>		
40 049 521	2	LED Seitenmarkierungsleuchte + seitliche Blinkleuchte Kat. 5, PRO-MULTI-SML , dito., AMP Super Seal Steacker 3-polig <i>LED Sidemarker Lamp incl. lateral LED Direction Indicator Lamp cat. 5, PRO-MULTI-SML, AMP SS con. 3-pol.</i>	 Kategorie 5 + LED SML	
50 079 400	1	Steckverbinder Buchsengehäuse 3-polig, AMP SUPER SEAL <i>Connector 3-poles female, AMP SUPER SEAL</i>		

LED Seitenmarkierungsleuchte

LED Sidemarker Lamp

Typ: PRO-BUTTON



Artikel-Nr. Reference-No.	VE QTY	Beschreibung Description	LED Seitenmarkierungs- leuchten LED Sidemarker Lamps	LED Technik LED Technology
40 065 001	2	LED Seitenmarkierungsleuchte PRO-BUTTON , wasserdicht vergossenes Gehäuse, Kabel 0,5m, 12/24 Volt, EMV & ADR geprüft IP6K9K <i>LED Sidemarker Lamp PRO-BUTTON waterproof casted, cable 0,5m 12/24 Volt, EMC & ADR appr. IP6K9K</i>		
40 065 011	2	LED Seitenmarkierungsleuchte PRO-BUTTON , wasserdicht vergossenes Gehäuse, 3M Selbstklebefolie für Schnellmontage, Kabel 0,5m, 12/24 Volt, EMV & ADR geprüft, IP6K9K <i>LED Sidemarker Lamp PRO-BUTTON waterproof casted, 3M adhesive pad for quick fixation, cable 0,5m, 12/24 Volt, EMC & ADR appr. IP6K9K</i>		
40 065 201	2	LED Seitenmarkierungsleuchte PRO-BUTTON , wasserdicht vergossenes Gehäuse, Flachkabel 0,5m, 12/24 Volt, EMV & ADR geprüft IP6K9K <i>LED Sidemarker Lamp PRO-BUTTON waterproof casted, flatcable 0,5m 12/24 Volt, EMC & ADR appr. IP6K9K</i>		
50 142 000	1	Blinkersteuerung für Seitenmarkierungsleuchten PRO-BLINK , Typ Universal, Ein-/Ausgangskabel open end, 10-30V, gem. ECE R48, Rev.6 <i>Direction Indicator Control System for Sidemarker Lamps, PRO-BLINK, type universal, Input/Output-Cable open end, 10-30V, according to ECE R48, rev.6</i>		

LED Seitenmarkierungsleuchte

LED Sidemarker Lamp

Typ: PRO-SUPER-FLAT

Artikel-Nr. Reference-No.	VE QTY	Beschreibung Description	LED Seitenmarkierungs- leuchten LED Sidemarker Lamps	LED Technik LED Technology
40 063 001	2	<p>LED Seitenmarkierungsleuchte PRO-SUPER-FLAT, Anbaulage horizontal oder vertikal, wasserdicht vergossenes Gehäuse, Kabel 0,5m, 12/24 Volt, EMV & ADR geprüft IP6K9K</p> <p><i>LED Sidemarker Lamp PRO-SUPER-FLAT, fixation horizontal or vertical, waterproof casted, cable 0,5m, 12/24 Volt, EMC & ADR appr. IP6K9K</i></p>		
40 063 011	2	<p>LED Seitenmarkierungsleuchte PRO-SUPER-FLAT, Anbaulage horizontal oder vertikal, wasserdicht vergossenes Gehäuse, 3M Selbstklebefolie für Schnellmontage, Kabel 0,5m, 12/24 Volt, EMV & ADR geprüft IP6K9K</p> <p><i>LED Sidemarker Lamp PRO-SUPER-FLAT, fixation horizontal or vertical, waterproof casted, 3M adhesive pad for quick fixation, cable 0,5m, 12/24 Volt, EMC & ADR appr. IP6K9K</i></p>		
40 063 021	2	<p>LED Seitenmarkierungsleuchte PRO-SUPER-FLAT, 90° Winkelhalter, Anbaulage horizontal oder vertikal, wasserdicht vergossenes Gehäuse, Kabel 0,5m, 12/24 Volt, EMV & ADR geprüft IP6K9K</p> <p><i>LED Sidemarker Lamp PRO-SUPER-FLAT, 90° bracket, fixation horizontal or vertical, waterproof casted, cable 0,5m, 12/24 Volt, EMC & ADR appr. IP6K9K</i></p>		
40 063 314	2	<p>Winkelhalter für LED Seitenmarkierungsleuchte PRO-SUPER-FLAT</p> <p><i>90°-Bracket for LED Sidemarker Lamp PRO-SUPER-FLAT</i></p>		

LED Seitenmarkierungsleuchte

LED Sidemarker Lamp

Typ: **PRO-SUPER-FLAT**



Artikel-Nr. Reference-No.	VE QTY	Beschreibung Description	LED Seitenmarkierungs- leuchten LED Sidemarker Lamps	LED Technik LED Technology
40 063 601	2	<p>LED Seitenmarkierungsleuchte PRO-SUPER-FLAT, Anbaulage horizontal oder vertikal, wasserdicht vergossenes Gehäuse, Kabel 0,5m + P&R Stecker, 12/24 Volt, EMV & ADR geprüft IP6K9K</p> <p><i>LED Sidemarker Lamp PRO-SUPER-FLAT, fixation horizontal or vertical, waterproof casted, cable 0,5m + P&R con., 12/24 Volt, EMC & ADR appr. IP6K9K</i></p>		
40 063 201	2	<p>LED Seitenmarkierungsleuchte PRO-SUPER-FLAT, Anbaulage horizontal oder vertikal, wasserdicht vergossenes Gehäuse, Flachkabel 0,5m, 12/24 Volt, EMV & ADR geprüft IP6K9K</p> <p><i>LED Sidemarker Lamp PRO-SUPER-FLAT, fixation horizontal or vertical, waterproof casted, flatcable 0,5m, 12/24 Volt, EMC & ADR appr. IP6K9K</i></p>		
40 063 071	2	<p>LED Seitenmarkierungsleuchte PRO-SUPER-FLAT, Anbaulage horizontal oder vertikal, wasserdicht vergossenes Gehäuse, AMP SuperSeal Stecker, 12/24V, EMV & ADR geprüft IP6K9K</p> <p><i>LED Sidemarker Lamp PRO-SUPER-FLAT, fixation horizontal or vertical, waterproof casted, AMP SuperSeal con., 12/24 Volt, EMC & ADR appr. IP6K9K</i></p>	 	
50 142 100	1	<p>Blinkersteuerung für Seitenmarkierungsleuchten PRO-BLINK, Typ Universal, Eingangskabel open end, Ausgang Flachkabel, 10-30V, gem. ECE R48, Rev.6</p> <p><i>Direction Indicator Control System for Sidemarker Lamps, PRO-BLINK, type universal, Input-Cable open end, Output-Cable flatcable, 10-30V, according to ECE R48, rev.6</i></p>		

LED Seitenmarkierungsleuchte

LED Sidemarker Lamp

**Typ: PRO-REP
Hotmelt Technik**









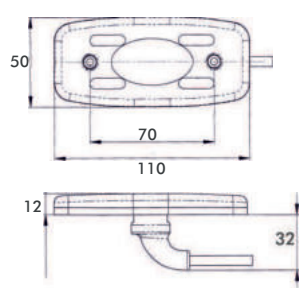

Artikel-Nr. Reference-No.	VE QTY	Beschreibung Description	LED Seitenmarkierungs- leuchten LED Sidemarker Lamps	LED Technik LED Technology
40 015 501 24V	2	LED Seitenmarkierungsleuchte 90°-Kabelanschluß im Hotmelt- Verfahren, Kabel 0,5m, IP54, 24V/0,8W - 12V/0,4W		
40 015 201 12V	2	LED Sidemarker Lamp, 90°-cable connection, cable 0,5m, IP54, 24V/0,8W - 12V/0,4W		
40 015 521 24V	2	LED Seitenmarkierungsleuchte Winkelhalter, 90°-Kabelanschluß im Hotmelt-Verfahren, Kabel 0,5m, IP54, 24V/0,8W		
40 015 601 24V	2	LED Seitenmarkierungsleuchte 90°-Kabelanschluß im Hotmelt- Verfahren, Kabel 0,5m mit P&R Stecker, IP54, 24V/0,8W - 12V/0,4W		
40 015 261 12V	2	LED Sidemarker Lamp, 90°-cable connection, cable 0,5m with P&R connector, IP54, 24V/0,8W - 12V/0,4W		
40 015 241 12V	2	LED Seitenmarkierungsleuchte 90°-Kabelanschluß im Hotmelt-Verfahren, Flachkabel 0,5m, IP54, 12V/0,4W		
40 157 314	10	Winkelhalter für LED Seitenmarkierungsleuchte 90°-Bracket for LED Sidemarker Lamp		
50 081 200	1	PU-Flachkabel 200m für Aspöck P&R Steckersystem PU-Flat-Cable 200m for Aspöck P&R connector system	H: 43	
40 157 414	10	Winkelhalter lange Version für LED Seitenmarkierungsleuchten Bracket 90°, long version LED Sidemarker Lamp		
40 157 514	10	Halter gerade, lange Version für LED Seitenmarkierungsleuchten Bracket long version for LED Sidemarker Lamp		

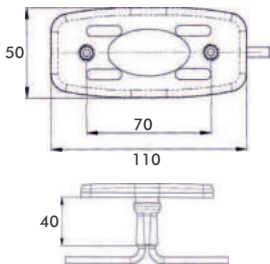
LED Seitenmarkierungsleuchte

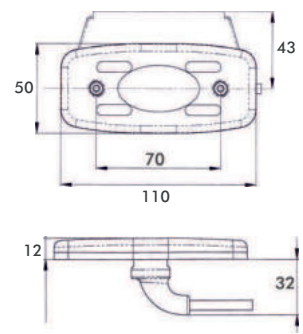
LED Sidemarker Lamp

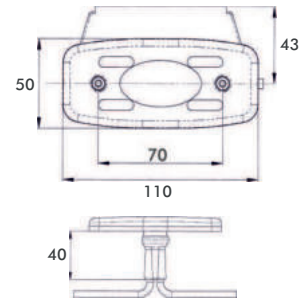









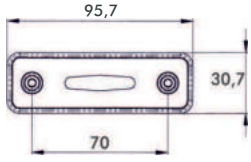

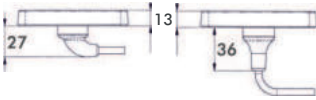
Artikel-Nr. Reference-No.	VE QTY	Beschreibung Description	LED Seitenmarkierungs- leuchten LED Sidemarker Lamps	LED Technik LED Technology
40 197 501 24V	2	LED Seitenmarkierungsleuchte, 90°-Kabelanschluß im Hotmelt- Verfahren, Kabel 0,5m, 24V/1W - 12V/1W <i>LED Sidemarker Lamp, 90°-cable connection, cable 0,5m, 24/1W - 12V/1W</i>		
40 197 201 12V	2			
40 197 511 24V	2	LED Seitenmarkierungsleuchte, T-Stück Anschluß im Hotmelt- Verfahren, 2 x Kabel 0,2m, 24V/1W <i>LED Sidemarker Lamp, T-cable connection, cable 2 x 0,2m, 24V/1W</i>		
40 197 521 24V	2	LED Seitenmarkierungsleuchte, Winkelhalter, 90°-Kabelanschluß im Hotmelt-Verfahren, Kabel 0,5m, 24V/1W - 12V/1W <i>LED Sidemarker Lamp, 90° bracket, 90°-cable connection, cable 0,5m, 24/1W - 12V/1W</i>		
40 197 221 12V	2			
40 197 531 24V	2	LED Seitenmarkierungsleuchte, Winkelhalter, T-Stück Anschluß im Hotmelt-Verfahren, 2 x Kabel 0,2m, 24V/1W <i>LED Sidemarker Lamp, 90° bracketT-cable connection, cable 2 x 0,2m, 24V/1W</i>		
40 157 314	10	Winkelhalter für LED Begrenzungsleuchte <i>90°-Bracket for LED Position Lamp</i>	 H: 43 40 157 314	

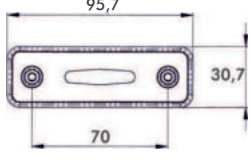
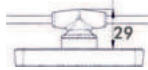
LED Seitenmarkierungsleuchte

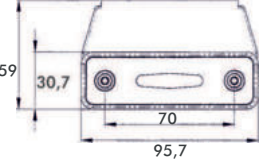
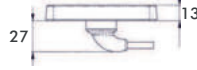
LED Sidemarker Lamp

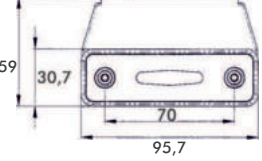

Artikel-Nr. Reference-No.	VE QTY	Beschreibung Description	LED Seitenmarkierungs- leuchten LED Sidemarker Lamps	LED Technik 24V LED Technology 24V
40 157 501	2	LED Seitenmarkierungsleuchte, 90°-Kabelanschluß im Hotmelt- Verfahren, Kabel 0,5m, 24V/0,8W <i>LED Sidemarker Lamp, 90°-cable connection, cable 0,5m, 24V/0,8W</i>		
40 157 541	2	LED Seitenmarkierungsleuchte, dito., gerader Kabelanschluß <i>LED Sidemarker Lamp, straight-cable connection</i>	  40 157 501 40 157 541	
40 157 511	2	LED Seitenmarkierungsleuchte, T-Stück Anschluß im Hotmelt- Verfahren, 2 x Kabel 0,2m, 24V/0,8W <i>LED Sidemarker Lamp, T-cable connection, cable 2 x 0,2m, 24V/0,8W</i>	  40 157 511	 
40 157 521	2	LED Seitenmarkierungsleuchte, Winkelhalter, 90°-Kabelanschluß im Hotmelt-Verfahren, Kabel 0,5m, 24V/0,8W <i>LED Sidemarker Lamp, 90° bracket, 90°-cable connection, cable 0,5m, 24V/0,8W</i>	  40 157 521	 
40 157 531	2	LED Seitenmarkierungsleuchte, Winkelhalter, T-Stück Anschluß im Hotmelt-Verfahren, 2 x Kabel 0,2m, 24V/0,8W <i>LED Sidemarker Lamp, 90° bracketT-cable connection, cable 2 x 0,2m, 24V/0,8W</i>	  40 157 531	 

Verkabelte LED Seitenmarkierungsleuchte

Cabled LED Sidemarker Lamp



Artikel-Nr. Reference-No.	VE QTY	Beschreibung Description	LED Seitenmarkierungs- leuchten LED Sidemarker Lamps	LED Technik 24V LED Technology 24V
90 157 506	1	LED SML-Reparaturkit, anbaufertig verkabelt mit 2 x 3 Leuchten 24V/0,8W <i>LED SML Repairkit, complete cabled, ready for fixation, 2 x 3 lamps, 24V/0,8W</i>		 Anschlußleitung/Cable : 4000mm Kabellänge zwischen den Leuchten/ Cable length between the lamps: 3500mm
90 157 508	1	LED SML-Reparaturkit, anbaufertig verkabelt mit 2 x 4 Leuchten 24V/0,8W <i>LED SML Repairkit, complete cabled, ready for fixation, 2 x 4 lamps, 24V/0,8W</i>		 Anschlußleitung/Cable : 4000mm Kabellänge zwischen den Leuchten/ Cable length between the lamps: 3500mm
90 157 510	1	LED SML-Reparaturkit, anbaufertig verkabelt mit 2 x 5 Leuchten 24V/0,8W <i>LED SML Repairkit, complete cabled, ready for fixation, 2 x 5 lamps, 24V/0,8W</i>		 Anschlußleitung/Cable : 4000mm Kabellänge zwischen den Leuchten/ Cable length between the lamps: 3500mm

LED Seitenmarkierungsleuchte

LED Sidemarker Lamp











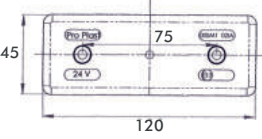

Artikel-Nr. Reference-No.	VE QTY	Beschreibung Description	LED Seitenmarkierungs- leuchten LED Sidemarker Lamps	LED Technik LED Technology	
40 157 001 24V	2	LED Seitenmarkierungsleuchte, ultraschallverschweißte, wasserdichte Leuchteneinheit, Winkelanschluß mit PG-Versch., Kontaktstecker 2,8mm <i>LED Sidemarker Lamp, waterproofed housing, 90° connector with PG-screw, 2,8mm terminals</i>			
40 157 021 24V	2	LED Seitenmarkierungsleuchte, ultraschallverschweißte, wasserdichte Leuchteneinheit, Winkelanschluß mit PG-Versch., Kontaktstecker 2,8mm, Befestigungswinkel 90° <i>LED Sidemarker Lamp, waterproofed housing, 90° connector with PG-screw, 2,8mm terminals, bracket 90°</i>			
40 157 221 12V	2	LED Seitenmarkierungsleuchte, ultraschallverschweißte, wasserdichte Leuchteneinheit, T-Stück Anschluß mit PG-Versch., Kontaktstecker 2,8mm, Befestigungswinkel 90° <i>LED Sidemarker Lamp, waterproofed housing, T-connector with PG-screw, 2,8mm terminals, bracket 90°</i>			
40 157 031 24V	2	LED Seitenmarkierungsleuchte, ultraschallverschweißte, wasserdichte Leuchteneinheit, T-Stück Anschluß mit PG-Versch., Kontaktstecker 2,8mm, Befestigungswinkel 90° <i>LED Sidemarker Lamp, waterproofed housing, T-connector with PG-screw, 2,8mm terminals, bracket 90°</i>			
40 157 101 24V	2	LED Lichtscheibeneinheit für LED Seitenmarkierungsleuchte <i>LED Lens for LED SML</i>			
40 157 314	10	Winkelhalter für LED Seitenmarkierungsleuchte <i>90°-Bracket for LED Sidemarker Lamp</i>			
40 157 514	10	Halter gerade, lange Version für LED Seitenmarkierungsleuchten <i>Bracket long version for LED Sidemarker Lamp</i>			
40 157 204	10	Winkelanschluß mit PG Versch. <i>90° Connector with PG screw</i>			
40 157 214	10	T-Stück Anschluß mit PG Versch. <i>T-Connector with PG screw</i>			
40 157 224	10	Anschlußstück gerade mit PG Versch. <i>Straight Connector with PG screw</i>			
			40 157 204	40 157 214	40 157 224

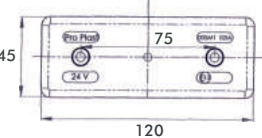
LED Seitenmarkierungsleuchte

LED Sidemarker Lamp

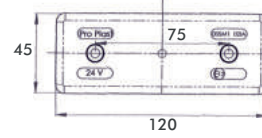

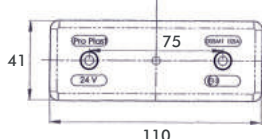
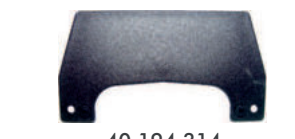
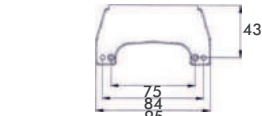
Artikel-Nr. Reference-No.	VE QTY	Beschreibung Description	LED Seitenmarkierungs- leuchten LED Sidemarker Lamps	LED Technik LED Technology
40 194 001 24V	2	LED Seitenmarkierungsleuchte, 90°-Kabelanschluß im Hotmelt- Verfahren, Kabel 0,5m, 24V/1W <i>LED Sidemarker Lamp, 90°-cable connection, cable 0,5m, 24V/1W</i>	 40 194 001	 45 75 120
40 194 011 24V	2	LED Seitenmarkierungsleuchte, dito., gerader Kabelanschluß <i>LED Sidemarker Lamp, straight-cable connection</i>	 40 194 011	 35 22 7 23 36
40 194 601 24V	2	LED Seitenmarkierungsleuchte, 90°-Kabelanschluß im Hotmelt- Verfahren, Kabel 0,5m mit P&R Stecker, 24V/1W <i>LED Sidemarker Lamp, 90°-cable connection, cable 0,5m w. P&R connector, 24V/1W</i>	 40 194 601	 45 75 120
40 194 611 24V	2	LED Seitenmarkierungsleuchte, dito., gerader Kabelanschluß <i>LED Sidemarker Lamp, straight-cable connection</i>	 40 194 611	 35 22 7 23 36
40 194 201 12V	2	LED Seitenmarkierungsleuchte, 90°-Kabelanschluß im Hotmelt- Verfahren, Kabel 0,5m, 12V/1W <i>LED Sidemarker Lamp, 90°-cable connection, cable 0,5m, 12V/1W</i>	 40 194 201	 45 75 120 35 22 7
40 016 501 24V	2	LED Seitenmarkierungsleuchte, 90°-Kabelanschluß im Hotmelt-Verfahren, Kabel 0,5m, 110x41x6,5mm, 24V/1W <i>LED Sidemarker Lamp, 90°-cable connection, cable 0,5m, 110x41x6,5mm, 24V/1W</i>	 40 016 501	 41 75 110 32 24 6,5
40 194 314	10	Winkelhalter für LED Seitenmarkierungsleuchte <i>90°-Bracket for LED Sidemarker Lamp</i>	 40 194 314	Befestigungslochabstand 30 u. 55mm  43 75 84 95

LED Seitenmarkierungsleuchte

LED Sidemarker Lamp



Artikel-Nr. Reference-No.	VE QTY	Beschreibung Description	LED Seitenmarkierungs- leuchten LED Sidemarker Lamps	LED Technik 24V / 0,55W LED Technology 24V / 0,55W
40 155 001	2	<p>LED Seitenmarkierungsleuchte mit Rückstrahler, Kabelein-/ausgang PG-Verschraubung 24V/0,55W</p> <p><i>LED Sidemarker Lamp with reflex reflector, cable entrance/-exit PG-Screw 24V/0,55W</i></p>		
40 155 021	2	<p>LED Seitenmarkierungsleuchte inkl. Winkelhalter, Kabelein-/ausgang PG-Verschraubung 24V/0,55W</p> <p><i>LED Sidemarker Lamp incl. Bracket 90°, cable entrance/-exit PG-Screw 24V/0,55W</i></p>		
90 155 021	2	<p>LED Seitenmarkierungsleuchte inkl. Winkelhalter, Kabelein-/ausgang PG-Verschraubung, Kabel 0,5m, 24V/0,55W</p> <p><i>LED Sidemarker Lamp incl. Bracket 90°, cable entrance/-exit PG-Screw cable 0,5m, 24V/0,55W</i></p>		
40 155 621	2	<p>LED Seitenmarkierungsleuchte mit PG-Verschraubung, Winkelhalter, Kabel 0,5m mit P&R Stecker, 24V/0,8W</p> <p><i>LED Sidemarker Lamp with PG-screw, bracket 90°, cable 0,5m, w. P&R connector, 24V/0,8W</i></p>		

Verkabelte LED Seitenmarkierungsleuchte

Cabled LED Sidemarker Lamp



Artikel-Nr. Reference-No.	VE QTY	Beschreibung Description	LED Seitenmarkierungs- leuchten LED Sidemarker Lamps	LED Technik 24V / 0,55W LED Technology 24V / 0,55W
90 155 006	1	LED SML-Reparaturkit, ERS anbaufertig verkabelt mit 2 x 3 Leuchten 24V/0,55W <i>LED SML Repairkit, ERS complete cabled, ready for fixation, 2 x 3 lamps, 24V/0,55W</i>		 Anschlußleitung/Cable : 4000mm Kabellänge zwischen den Leuchten/ Cable length between the lamps: 3500mm
90 155 008	1	LED SML-Reparaturkit, ERS anbaufertig verkabelt mit 2 x 4 Leuchten 24V/0,55W <i>LED SML Repairkit, ERS complete cabled, ready for fixation, 2 x 4 lamps, 24V/0,55W</i>		 Anschlußleitung/Cable : 4000mm Kabellänge zwischen den Leuchten/ Cable length between the lamps: 3500mm
90 155 010	1	LED SML-Reparaturkit, ERS anbaufertig verkabelt mit 2 x 5 Leuchten 24V/0,55W <i>LED SML Repairkit, ERS complete cabled, ready for fixation, 2 x 5 lamps, 24V/0,55W</i>		 Anschlußleitung/Cable : 4000mm Kabellänge zwischen den Leuchten/ Cable length between the lamps: 3500mm
50 080 000	1	50m ADR-Rundleitung FLRYY 2 x 1,0 für Seitenmarkierungsleuchten <i>50m ADR Cable round, FLRYY 2 x 1,0 for Sidemarker Lamps</i>		

LED Seitenmarkierungsleuchte

LED Sidemarker Lamp











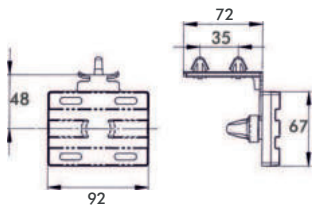

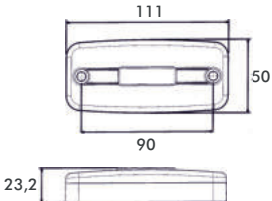
Artikel-Nr. Reference-No.	VE QTY	Beschreibung Description	LED Seitenmarkierungs- leuchten LED Sidemarker Lamps	LED Technik LED Technology
40 034 001	2	LED Seitenmarkierungs- leuchte gelb mit AMP Superseal Anschluss, 12/24V LED Sidemarker Lamp amber with AMP superseal connector, 12/24V		
40 034 501	2	LED Seitenmarkierungs- leuchte gelb mit Flachkabel 0,5m, 12/24V LED Sidemarker Lamp amber with flat cable 0,5m, 12/24V		
40 034 314	1	Winkelhalter für LED Leuchtenserie 034 Bracket 90° for LED lamp serie 034		
50 105 005	1	Kabel 0,5m mit AMP Superseal Stecker für LED Leuchtenserie 034 Cable 0,5m with AMP Superseal connector for LED lamp serie 034		
50 105 015	1	Kabel 1,5m mit AMP Superseal Stecker für LED Leuchtenserie 034 Cable 1,5m with AMP Superseal connector for LED lamp serie 034		
50 079 200	1	Steckverbinder Buchsengehäuse 2-polig, AMP SUPER SEAL Connector 2-poles female, AMP SUPER SEAL		

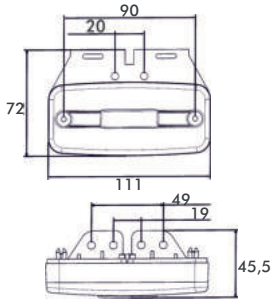
LED Seitenmarkierungsleuchte

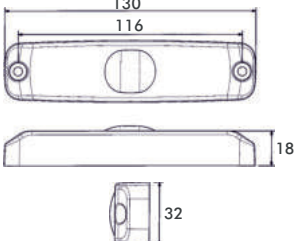
LED Sidemarker Lamp

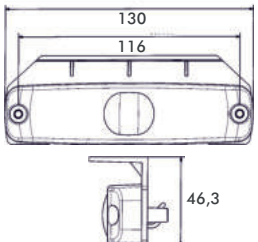

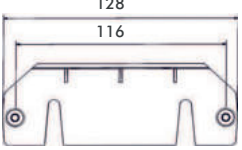
Artikel-Nr. Reference-No.	VE QTY	Beschreibung Description	LED Seitenmarkierungs- leuchten LED Sidemarker Lamps	LED Technik LED Technology
40 151 601	2	LED Seitenmarkierungsleuchte mit Rückstrahler und Anschluss für Flachkabel, Kabel 0,2m, Clipswinkel, 24V/1W KÖGEL Nr.: 332 789 <i>LED Sidemarker Lamp with reflex reflector and flatcable-connection, cable 0,2m, 24V/1W</i>		
40 120 001	1	LED Seitenmarkierungsleuchte Kabel 0,5m, 10-30V <i>LED Sidemarker Lamp, cable 0,5m, 10-30V</i>		
40 120 021	1	LED Seitenmarkierungsleuchte mit Winkelhalter, Kabel 0,5m, 10-30V <i>LED Sidemarker Lamp with bracket 90°, cable 0,5m, 10-30V</i>		
40 023 901	2	LED Seitenmarkierungsleuchte mit Rückstrahler, wasserdichtes Gehäuse inkl. Kabel 1,5m, 12/24V, ADR geprüft <i>LED Sidemarker Lamp with Reflex Reflector, waterproofed housing incl. cable 1,5m, 12/24V, ADR approved</i>	 	
40 023 921	2	LED Seitenmarkierungsleuchte mit Rückstrahler und Winkelhalter, wasserdichtes Gehäuse inkl. Kabel 1,5m, 12/24V, ADR geprüft <i>LED Sidemarker Lamp with Reflex Reflector and bracket 90°, waterproofed housing including cable 1,5m, 12/24V, ADR approved</i>	 	
40 023 314	2	Winkelhalter für LED Leuchtenserie 023 <i>Bracket 90° for LED lamp serie 023</i>		

LED Seitenmarkierungsleuchte

LED Sidemarker Lamp

Typ: PRO-CAN XL

Artikel-Nr. Reference-No.	VE QTY	Beschreibung Description	LED Seitenmarkierungs- leuchten LED Sidemarker Lamps	LED Technik LED Technology
40 026 091 24V	2	LED Seitenmarkierungsleuchte PRO-CAN XL Lichtleitertechnik Kabel 0,5m, wasserdichtes, vergossenes Leuchtgehäuse, Anbau horizontal o. vertikal <i>LED Sidemarker Lamp, PRO CAN XL Light guide technology, incl. cable 0,5m, potted version</i>	 Lichtleitertechnik/ Light guide technology	24V / 0,8W - 12V / 1,5W Leuchte in Funktion/Lamp in function
40 026 001 24V	2	LED Seitenmarkierungsleuchte PRO-CAN XL Kabel 0,5m, wasserdichtes, vergossenes Leuchtgehäuse, Anbau horizontal o. vertikal <i>LED Sidemarker Lamp, PRO CAN XL incl. cable 0,5m, potted version</i>	 18 LEDs	 252 230 22
40 026 201 12V	2	<i>LED Sidemarker Lamp, PRO CAN XL incl. cable 0,5m, potted version</i>		 18
40 026 021 24V	2	LED Seitenmarkierungsleuchte PRO-CAN XL Kabel 0,5m, Winkelhalter mit Rückstrahler, wasserdichtes, vergossenes Leuchtgehäuse, Anbau horizontal o. vertikal <i>LED Sidemarker Lamp, PRO CAN XL incl. cable 0,5m, bracket 90° incl. reflex reflector, potted version</i>	 18 LEDs	 55 230 256 13,5 55 30 5 23,5 46
40 026 801 24V	2	Kombinierte LED SML + Seitliche LED Blinkleuchte PRO-CAN XL , Kat.5, Kabel 0,5m, wasserdichtes, vergossenes Leuchtgehäuse, Anbau horizontal o. vertikal <i>LED SML + Lateral LED Dir. Indicator Lamp PRO-CAN XL, cat.5 incl. cable 0,5m, potted version, for horizontal or vertical fixation</i>	 18 LEDs Kategorie 5 + LED SML	 252 230 22 18
40 026 311	1	Winkelhalter mit integriertem Rückstrahler gelb für Leuchten- serie PRO-CAN XL <i>Bracket 90° with reflex reflector amber for lamp serie PRO-CAN XL</i>	 40 026 311	 55 230
40 026 314	1	Winkelhalter für Leuchten- serie PRO-CAN XL <i>Bracket 90° for lamp serie PRO-CAN XL</i>	 40 026 314	 256

LED Seitenmarkierungsleuchte

LED Sidemarker Lamp

Typ: **PRO-CAN**



Artikel-Nr. Reference-No.	VE QTY	Beschreibung Description	LED Seitenmarkierungs- leuchten LED Sidemarker Lamps	LED Technik LED Technology
40 017 001 24V	2	LED Seitenmarkierungsleuchte PRO-CAN Kabel 0,5m, wasserdichtes, komplett vergossenes Leuchtengehäuse, 24V/0,8W <i>LED Sidemarker Lamp, PRO CAN incl. cable 0,5m, potted version, 24V/0,8W</i>		
40 017 201 12V	2	LED Seitenmarkierungsleuchte PRO-CAN Kabel 0,5m, wasserdichtes, komplett vergossenes Leuchtengehäuse, 12V/0,4W <i>LED Sidemarker Lamp, PRO CAN incl. cable 0,5m, potted version, 12V/0,4W</i>		
40 017 021 24V	2	LED Seitenmarkierungsleuchte PRO-CAN gelb, Chrom Gehäuse, Kabel 0,5m, wasserdichtes, vergossenes Leuchtengehäuse, 24V/0,8W <i>LED Sidemarker Lamp PRO CAN amber, chrome housing, incl. cable 0,5m, potted version, 24V/0,8W</i>		
20 017 101	10	Rückstrahler PRO-CAN gelb mit Selbstklebefolie <i>Reflex reflector PRO-CAN amber</i>		

LED Seitenmarkierungsleuchte

LED Sidemarker Lamp

Typ: PRO-FLAT, PRO-SLIM









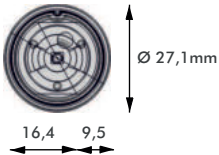

Artikel-Nr. Reference-No.	VE QTY	Beschreibung Description	LED Seitenmarkierungs- leuchten LED Sidemarker Lamps	LED Technik LED Technology
40 061 001	2	<p>LED Seitenmarkierungsleuchte PRO-FLAT, Kabel 0,25m, wasserdichtes, vergossenes Leuchtgehäuse, 3M Selbstklebefolie für Schnellmontage oder alternativ Schraubbefestigung, EMV geprüft, 12V/24V</p> <p><i>LED Sidemarker Lamp PRO-FLAT incl. cable 0,25m, potted version, adhesive pad for quick fixation, alternatively screw fixation, EMC approved, 12V/24V</i></p>		
40 061 011	2	<p>LED Seitenmarkierungsleuchte PRO-FLAT „Color Edition“ Kabel 0,25m, wasserdichtes, vergossenes Leuchtgehäuse, 3M Selbstklebefolie für Schnellmontage oder alternativ Schraubbefestigung, EMV geprüft, 12V/24V</p> <p><i>LED Sidemarker Lamp PRO-FLAT „Color Edition“, cable 0,25m, potted version, adhesive pad for quick fixation, alternatively screw fixation, EMC approved, 12V/24V</i></p>		
40 044 001 24V	2	<p>LED Seitenmarkierungsleuchte PRO-SLIM gelb, Kabel 0,5m, wasserdichtes, vergossenes Leuchtgehäuse, 24V/0,8W, ADR-geprüft, IP6K9K</p> <p><i>LED Sidemarker Lamp PRO-SLIM amber, incl. cable 0,5m, potted version, 24V/0,8W, ADR-appr., IP6K9K</i></p>		
40 044 201 12V	2	<p>LED Seitenmarkierungsleuchte PRO-SLIM dito., 12V/0,8W</p> <p><i>LED Sidemarker Lamp PRO-SLIM dito, 12V/0,8W</i></p>		
40 044 011 24V	2	<p>LED Seitenmarkierungsleuchte PRO-SLIM gelb, Gehäuse glasklar, Kabel 0,5m, wasserdichtes, vergossenes Leuchtgehäuse, 24V/0,8W, ADR-geprüft, IP6K9K</p> <p><i>LED Sidemarker Lamp PRO-SLIM amber, clear housing, incl. cable 0,5m, potted version, 24V/0,8W, ADR-appr., IP6K9K</i></p>		
40 044 211 12V	2	<p>LED Seitenmarkierungsleuchte PRO-SLIM dito., 12V/0,8W</p> <p><i>LED Sidemarker Lamp PRO-SLIM dito, 12V/0,8W</i></p>		

LED Seitenmarkierungsleuchte

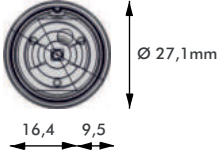
LED Sidemarker Lamp

Typ: **PRO-PENNY, Universal**

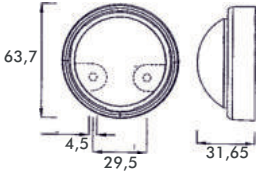

Artikel-Nr. Reference-No.	VE QTY	Beschreibung Description	LED Seitenmarkierungsleuchten LED Sidemarker Lamps	LED Technik LED Technology
40 002 001	2	LED Seitenmarkierungsleuchte PRO-PENNY gelb, Kabel 0,5m, wasserdichtes, vergossenes Leuchtgehäuse, sichere Befestigung mit 3M Selbstklebefolie, 12V/24V, ADR gerüft, IP6K9K <i>LED Sidemarker Lamp PRO-PENNY amber, incl. cable 0,5m, potted version, safely fixation with 3M adhesive pad, 12V/24V, ADR-appr., IP6K9K</i>		12V - 1,0W / 24V - 1,2W  
40 002 501	2	LED Seitenmarkierungsleuchte PRO-PENNY dito., Kabel 5,0m <i>LED Sidemarker Lamp PRO-PENNY dito, cable 5,0m</i>		
40 002 011	2	LED Seitenmarkierungsleuchte PRO-PENNY gelb, Gehäuse glasklar, Kabel 0,5m, wasserdichtes, vergossenes Leuchtgehäuse, sichere Befestigung mit 3M Selbstklebefolie, 12V/24V, ADR gerüft, IP6K9K <i>LED Sidemarker Lamp PRO-PENNY amber, clear housing, incl. cable 0,5m, potted version, safely fixation with 3M adhesive pad, 12V/24V ADR-appr., IP6K9K</i>		12V - 1,0W / 24V - 1,2W  
40 020 001	10	LED Seitenmarkierungsleuchte wasserdichtes Gehäuse, Kabel 0,3m, 9-36V <i>LED Sidemarker Lamp waterproofed housing, cable 0,3m, 9-36V</i>	 	

LED Seitenmarkierungsleuchte

LED Sidemarker Lamp

Typ: **UNIPOINT**



Artikel-Nr. Reference-No.	VE QTY	Beschreibung Description	LED Seitenmarkierungs- leuchten LED Sidemarker Lamps	LED Technik 24V / 1,3W LED Technology 24V / 1,3W
21 200 000 Aspöck-Nr.: 21-2000-005	1	LED Seitenmarkierungsleuchte UNIPOINT , Einbauversion, 24V/1,3W <i>LED Sidemarker Lamp UNIPOINT Recessed version, 24V/1,3W</i>		
21 200 001 Aspöck-Nr.: 21-2000-015	1	LED Seitenmarkierungsleuchte UNIPOINT , Anbauversion mit, 90° Winkelhalter, 24V/1,3W <i>LED Sidemarker Lamp UNIPOINT Pendant version with 90° bracket, 24V/1,3W</i>		
21 200 004 Aspöck-Nr.: 21-2000-045	1	LED Seitenmarkierungsleuchte UNIPOINT , Anbauversion mit, 90° Winkelhalter, 24V/1,3W, VERSION SCHMITZ <i>LED Sidemarker Lamp UNIPOINT Pendant version with 90° bracket, 24V/1,3W, VERSION SCHMITZ</i>	 VERSION SCHMITZ	
15 562 401 Aspöck-Nr.: 15-5624-014	1	Anschlußteilesatz, m. Einfachtülle für Seitenmarkierungsgl. UNIPOINT <i>Connector Kit for Sidemarker Lamp UNIPOINT, grommet with one hole</i>		
15 562 402 Aspöck-Nr.: 15-5624-024	1	Anschlußteilesatz, m. Doppeltülle für Seitenmarkierungsgl. UNIPOINT <i>Connector Kit for Sidemarker Lamp UNIPOINT, grommet with two holes</i>	 15 562 401	 15 562 402

LED Seitenmarkierungsleuchte

LED Sidemarker Lamp

Typ: UNIPOINT

Artikel-Nr. Reference-No.	VE QTY	Beschreibung Description	LED Seitenmarkierungs- leuchten LED Sidemarker Lamps	LED Technik 24V / 1,3W LED Technology 24V / 1,3W
31 200 401 Aspöck-Nr.: 31-2004-017	1	LED SML UNIPOINT , Kabel 0,5m mit Aspöck P&R Stecker, Einbauversion, 24V/1,3W LED SML UNIPOINT , cable 0,5m with Aspöck P&R connector, recessed version, 24V/1,3W		
31 200 403 Aspöck-Nr.: 31-2004-037	1	LED SML UNIPOINT dito. Kabel 1,5m LED SML UNIPOINT , cable 1,5m		
31 206 401 Aspöck-Nr.: 31-2064-017	1	LED SML UNIPOINT , Kabel 0,5m mit Aspöck P&R Stecker, Anbauversion, 24V/1,3W LED SML UNIPOINT , cable 0,5m with Aspöck P&R connector, pendant version, 24V/1,3W		
31 206 403 Aspöck-Nr.: 31-2064-037	1	LED SML UNIPOINT dito. Kabel 1,5m LED SML UNIPOINT , cable 1,5m		
31 210 401 Aspöck-Nr.: 31-2104-017	1	LED SML UNIPOINT , Kabel 0,5m mit Aspöck P&R Stecker, flacher Aufbau, 24V/1,3W LED SML UNIPOINT , cable 0,5m with Aspöck P&R connector, flat backside, 24V/1,3W		
15 562 401 Aspöck-Nr.: 15-5624-014	1	Anschlußteilsatz, m. Einfachtülle für Seitenmarkierungs-l. UNIPOINT Connector Kit for Sidemarker Lamp UNIPOINT , grommet with one hole		
15 562 402 Aspöck-Nr.: 15-5624-024	1	Anschlußteilsatz, m. Doppeltülle für Seitenmarkierungs-l. UNIPOINT Connector Kit for Sidemarker Lamp UNIPOINT , grommet with two holes		
			15 562 401	15 562 402
50 081 200	1	PU-Flachkabel 200m für Aspöck P&R Steckersystem PU-Flat-Cable 200m for Aspöck P&R connector system		

LED Seitenmarkierungsleuchte

LED Sidemarker Lamp

Typ: FLATPOINT

Artikel-Nr. Reference-No.	VE QTY	Beschreibung Description	LED Seitenmarkierungs- leuchten LED Sidemarker Lamps	LED Technik 24V / 1,3W LED Technology 24V / 1,3W
21 220 100 Aspöck-Nr.: 21-2201-004	1	LED Seitenmarkierungsleuchte FLATPOINT mit Einbaugehäuse, Bajonettanschluß mit Gummitülle 90°, 24V/1,3W <i>LED Sidemarker Lamp FLATPOINT incl. Recessed housing, bayonet joint and grommet 90°, 24V/1,3W</i>		
21 220 001 Aspöck-Nr.: 21-2200-014	1	LED Seitenmarkierungsleuchte FLATPOINT mit Schutzgehäuse, Bajonettanschluß mit Gummitülle 90°, Winkelhalter 90°, 24V/1,3W <i>LED Sidemarker Lamp FLATPOINT incl. protective housing, bayonet joint and grommet 90°, fixation bracket 90° 24V/1,3W</i>		
21 220 000 Aspöck-Nr.: 21-2200-004	1	LED Lichtscheibeneinheit für Seitenmarkierungsleuchte FLATPOINT <i>LED Lens for Sidemarker Lamp FLATPOINT</i>		
15 212 210 Aspöck-Nr.: 15-2122-104	1	Anschlußteilesatz für Seitenmarkierungsleuchte FLATPOINT <i>Connector Kit for Sidemarker Lamp FLATPOINT</i>		
68 500 001 Aspöck-Nr.: 68-5000-007	1	Anschlußkabel 0,5m mit Aspöck P&R Stecker <i>Cable 0,5m with Aspöck P&R connector</i>		
68 500 003 Aspöck-Nr.: 68-500-037	1	Anschlußkabel 1,5m mit Aspöck P&R Stecker <i>Cable 1,5m with Aspöck P&R connector</i>		
50 081 200	1	PU-Flachkabel 200m für Aspöck P&R Steckersystem <i>PU-Flat-Cable 200m for Aspöck P&R connector system</i>		

LED Seitenmarkierungsleuchte

LED Sidemarker Lamp

Typ: FLATPOINT

Artikel-Nr. Reference-No.	VE QTY	Beschreibung Description	LED Seitenmarkierungs- leuchten LED Sidemarker Lamps	LED Technik 24V / 1,3W LED Technology 24V / 1,3W
31 221 411 Aspöck-Nr.: 31-2214-117	1	LED SML FLATPOINT , Kabel 0,5m mit Aspöck P&R Stecker, Einbauversion, 24V/1,3W <i>LED SML FLATPOINT, cable 0,5m with Aspöck P&R connector, recessed version, 24V/1,3W</i>		
31 221 413 Aspöck-Nr.: 31-2214-137	1	LED SML FLATPOINT dito., Kabel 1,5m <i>LED SML FLATPOINT, cable 1,5m</i>		
31 221 401 Aspöck-Nr.: 31-2214-017	1	LED SML FLATPOINT , Kabel 0,5m mit Aspöck P&R Stecker, Aufbauversion, 24V/1,3W <i>LED SML FLATPOINT, cable 0,5m with Aspöck P&R connector, pendant version, 24V/1,3W</i>		
31 221 403 Aspöck-Nr.: 31-2214-037	1	LED SML FLATPOINT dito., Kabel 1,5m <i>LED SML FLATPOINT, cable 1,5m</i>		
21 220 000 Aspöck-Nr.: 21-220-004	1	LED Lichtscheibeneinheit für Seitenmarkierungs-l. FLATPOINT <i>LED Lens for Sidemarker Lamp FLATPOINT</i>		
15 212 210 Aspöck-Nr.: 15-2122-104	1	Anschlußteilesatz für Seitenmarkierungs-l. FLATPOINT <i>Connector Kit for Sidemarker Lamp FLATPOINT</i>		
68 500 001 Aspöck-Nr.: 68-5000-007	1	Anschlußkabel 0,5m mit Aspöck P&R Stecker <i>Cable 0,5m with Aspöck P&R connector</i>		
68 500 003 Aspöck-Nr.: 68-500-037	1	Anschlußkabel 1,5m mit Aspöck P&R Stecker <i>Cable 1,5m with Aspöck P&R connector</i>		
50 081 200	1	PU-Flachkabel 200m für Aspöck P&R Steckersystem <i>PU-Flat-Cable 200m for Aspöck P&R connector system</i>		

LED Seitenmarkierungsleuchte

LED Sidemarker Lamp

Typ: FLATPOINT II

Artikel-Nr. Reference-No.	VE QTY	Beschreibung Description	LED Seitenmarkierungs- leuchten LED Sidemarker Lamps	LED Technik 24V / 1,3W LED Technology 24V / 1,3W
31 230 401 Aspöck-Nr.: 31-2304-017	1	LED SML FLATPOINT II , Kabel 0,5m mit Aspöck P&R Stecker, Einbauversion, 24V/1,3W <i>LED SML FLATPOINT II, cable 0,5m with Aspöck P&R connector, recessed version, 24V/1,3W</i>		
31 236 408 Aspöck-Nr.: 31-2364-087	1	LED SML FLATPOINT II , Kabel 0,5m mit Aspöck P&R Stecker, Anbauversion, 24V/1,3W <i>LED SML FLATPOINT II, cable 0,5m with Aspöck P&R connector, pendant version, 24V/1,3W</i>		
31 230 901 Aspöck-Nr.: 31-2309-017	1	LED SML FLATPOINT II , Kabel 0,5m mit Aspöck DC-Stecksystem, Einbauversion, 12V/1,3W <i>LED SML FLATPOINT II, cable 0,5m with Aspöck DC-Connector System, recessed version, 12V/1,3W</i>		
31 236 902 Aspöck-Nr.: 31-2369-027	1	LED SML FLATPOINT II , Kabel 0,5m mit Aspöck DC-Stecksystem, Anbauversion, 12V/1,3W <i>LED SML FLATPOINT II, cable 0,5m with Aspöck DC-Connector System, pendant version, 12V/1,3W</i>		
68 500 001 Aspöck-Nr.: 68-5000-007	1	Anschlußkabel 0,5m mit Aspöck P&R Stecker <i>Cable 0,5m with Aspöck P&R connector</i>		
50 081 200	1	PU-Flachkabel 200m für Aspöck P&R Steckersystem <i>PU-Flat-Cable 200m for Aspöck P&R connector system</i>		
15 597 601	10	DC-Anschlußverbinder 12V <i>DC-Connector System 12V</i>		

68 500 001











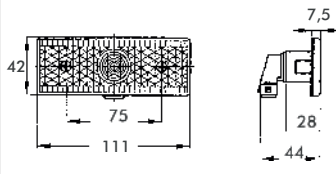

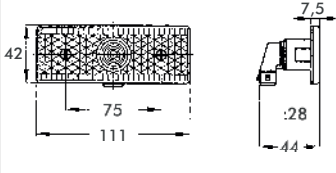

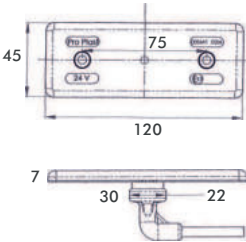

50 081 200

15 597 601

Seitenmarkierungsleuchte

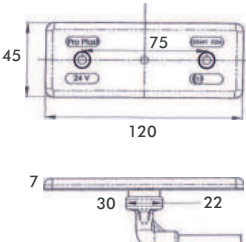
Sidemarker Lamp



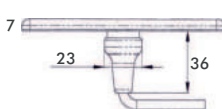



Typ: **passend für MERCEDES BENZ**

Artikel-Nr. Reference-No.	VE QTY	Beschreibung Description	Seitenmarkierungs- leuchten Sidemarker Lamps	
40 180 001	10	Seitenmarkierungsleuchte mit Rückstrahler MB SK und ACTROS, 12V/24V MB Nr.: 0005444111 <i>Sidemarker Lamp with Reflex Reflector for MB SK and ACTROS, 12V/24V</i>		W2,1x9,5d / W3W 
40 180 011	10	Seitenmarkierungsleuchte mit Rückstrahler und vergossenem Kabel 200mm, MB SK und ACTROS, 12V/24V MB Nr.: 0005444111 <i>Sidemarker Lamp with Reflex Reflector incl. cable 200mm MB SK and ACTROS, 12V/24V</i>		W2,1x9,5d / W3W 
40 180 204	10	Fassungsgehäuse für MB-SML 40 180 001 <i>Bulb Holder for MB-SML 40 180 001</i>		
40 180 214	10	Fassungsgehäuse für MB-SML 40 180 011, Kabel 200mm <i>Bulb Holder incl. cable 200mm for MB-SML 40 180 011</i>	40 180 204	40 180 214
40 194 301	2	LED SML, 90°-Kabelanschluß im Hotmelt-Verfahren, Kabel 0,2m inkl. Anschlußstecker, 24V/1W Reparaturvariante, MB ACTROS MB Nr.: 0005445411 MB Nr.: 0005446011 <i>LED SML, 90°-cable connection, cable 0,2m incl. connector, 24V/1W for MB ACTROS</i>	  	
40 194 001	2	LED Seitenmarkierungsleuchte, 90°-Kabelanschluß im Hotmelt-Verfahren, Kabel 0,5m, 24V/1W Reparaturvariante, MB ACTROS <i>LED Sidemarker Lamp, 90°-cable connection, cable 0,5m, 24V/1W for MB ACTROS</i>	  	
40 194 011	2	LED Seitenmarkierungsleuchte, gerader-Kabelanschluß <i>LED Sidemarker Lamp, straight-cable connection</i>	 40 194 001  40 194 011 	

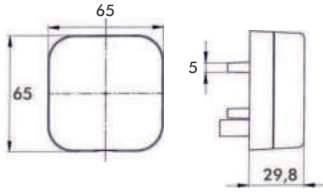
Seitenmarkierungsleuchte

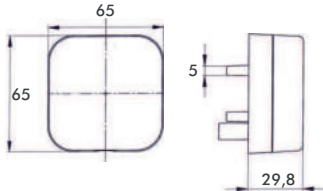
Sidemarker Lamp

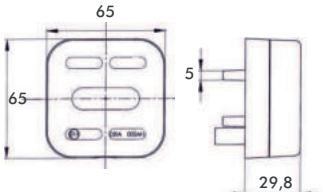

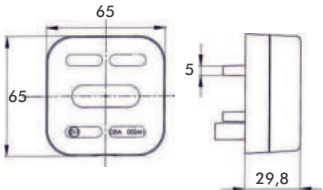



Typ: **passend für M.A.N.**

Artikel-Nr. Reference-No.	VE QTY	Beschreibung Description	Seitenmarkierungs- leuchten Sidemarker Lamps	
40 152 001	10	Seitenmarkierungsleuchte mit Rückstrahler, 12V/24V M.A.N. Nr.: 81.25260.6048 M.A.N. Nr.: 81.25260.6088 <i>Sidemarker Lamp with Reflex Reflector, 12V/24V</i>		SV 8,5 / C5W 
40 152 101	10	Lichtscheibe für M.A.N.-SML <i>Lens for M.A.N.-SML</i>	mit Glühlampe 24V/5W bestückt <i>including bulb 24V/5W</i>	
90 152 001	2	Seitenmarkierungsleuchte mit Rückstrahler, Kabel 0,5m, Reparaturvariante, 12V/24V M.A.N. Nr.: 81.25260.6048 M.A.N. Nr.: 81.25260.6088 <i>Sidemarker Lamp with Reflex Reflector, cable 0,5m, 12V/24V</i>		SV 8,5 / C5W 
40 152 101	10	Lichtscheibe für M.A.N.-SML <i>Lens for M.A.N.-SML</i>	mit Glühlampe 24V/5W bestückt <i>including bulb 24V/5W</i>	
40 187 001	2	LED Seitenmarkierungsleuchte mit Rückstrahler, 24V M.A.N. Nr.: 81.25260.6105 <i>LED Sidemarker Lamp with Reflex Reflector, 24V</i>	 LED	
40 187 101	10	Lichtscheibe für M.A.N. LED-SML <i>Lens for M.A.N.-LED SML</i>		
90 187 001	2	LED Seitenmarkierungsleuchte mit Rückstrahler, Kabel 0,5m, Reparaturvariante, 24V M.A.N. Nr.: 81.25260.6105 <i>LED Sidemarker Lamp with Reflex Reflector, cable 0,5m, 24V</i>	 LED	
40 187 101	10	Lichtscheibe für M.A.N. LED-SML <i>Lens for M.A.N.-LED SML</i>		

Seitenmarkierungsleuchte

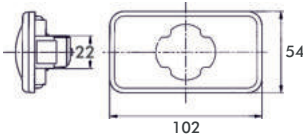

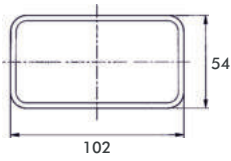
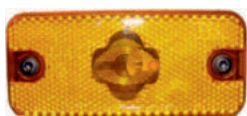
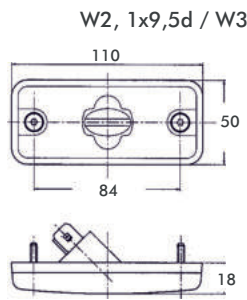



Sidemarker Lamp

Typ: passend für **VOLVO, SCANIA, IVECO, RENAULT, DAF**

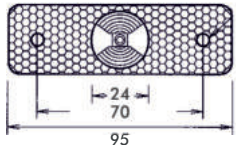
Artikel-Nr. Reference-No.	VE QTY	Beschreibung Description	Seitenmarkierungs- leuchten Sidemarker Lamps	
40 196 001	10	LED Seitenmarkierungsleuchte, VOLVO, 24V VOLVO Nr.: 20398660 <i>LED Sidemarker Lamp, VOLVO, 24V</i>	 	
40 198 001	2	LED Seitenmarkierungsleuchte, SCANIA, 24V SCANIA Nr.: 1446359 <i>LED Sidemarker Lamp, SCANIA, 24V</i>	 	
40 150 001	1	Seitenmarkierungsleuchte, mit Rückstrahler, 12V/24V DAF Nr.: 1302707 IVECO Nr.: 500308514 RENAULT Nr.: 5010231957 <i>Sidemarker Lamp with reflex refl., DAF, IVECO, RENAULT, 12V/24V</i>		W2, 1x9,5d / W3W 
40 150 501	10	Fassung für SML 40 150 001 <i>Bulb holder for SML 40 150 001</i>	 40 150 501	

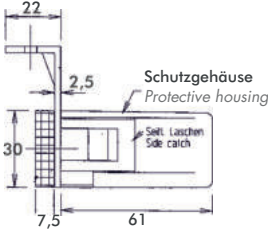
Seitenmarkierungsleuchte

Sidemarker Lamp

Artikel-Nr. Reference-No.	VE QTY	Beschreibung Description	Seitenmarkierungs- leuchten Sidemarker Lamps	BA 9s / T4W
40 128 001	10	Seitenmarkierungsleuchte mit Rückstrahler, Fassungsgehäuse mit Bajonettverschluß inkl. Glühlampe 24V/4W, Winkeltülle 12V/24V <i>Sidemarker Lamp, w. reflector, bulbholder w. bayonet joint incl. bulb 24V/4W, 90° grommet, 12V/24V</i>		
40 128 031	10	Seitenmarkierungsleuchte mit Rückstrahler, Fassungsgehäuse mit Bajonettverschluß inkl. Glühlampe 24V/4W, Winkeltülle, Schutzgehäuse m. Bef.winkel, 12V/24V <i>Sidemarker Lamp, w. reflector, bulbholder w. bayonet joint incl. bulb 24V/4W, 90° grommet, protective housing w. 90° bracket, 12V/24V</i>		
40 128 101	10	Lichtscheibe für Seitenmarkierungsleuchte <i>Lens for Sidemarker Lamp</i>		
40 128 254	10	Flex. Gummiunterlage für Seitenmarkierungsleuchte <i>Flex. support for Sidemarker Lamp</i>	40 128 101	40 128 254
40 128 204	10	Fassungsgehäuse inkl. Glühlampe für Seitenmarkierungsleuchte <i>Bulbholder incl. bulb for SML</i>		40 128 204

Seitenmarkierungsleuchte



Sidemarker Lamp



Artikel-Nr. Reference-No.	VE QTY	Beschreibung Description	Seitenmarkierungs- leuchten Sidemarker Lamps	
40 123 011	8	Seitenmarkierungsleuchte mit Rückstrahler, Dichtungsgummi zwischen Lichtscheibe und Gehäuse 1St.PG-Verschraubung, 12V/24V <i>Sidemarker Lamp with reflex reflector, rubber seal between lens and housing, 1pcs. PG-Screw, 12V/24V</i>		 BA 9s / T4W
40 124 011	6	Seitenmarkierungsleuchte mit Rückstrahler, Dichtungsgummi zwischen Lichtscheibe und Gehäuse, 1St.PG-Verschraubung, Flex. Pendelhalter, 12V/24V <i>Sidemarker Lamp with reflex reflector, rubber seal between lens and housing, 1pcs. PG-Screw, Flex. Bracket, 12V/24V</i>		 BA 9s / T4W
40 125 011	6	Seitenmarkierungsleuchte mit Rückstrahler, Dichtungsgummi zwischen Lichtscheibe und Gehäuse, 1St.PG-Verschraubung, Flex. Pendelhalter 90°, 12V/24V <i>Sidemarker Lamp with reflex reflector, rubber seal between lens and housing, 1pcs. PG-Screw, Flex. Bracket 90°, 12V/24V</i>		 BA 9s / T4W
40 123 101	10	Lichtscheibe für Seitenmarkierungsleuchte 40 123 011, 40 124 011, 40 125 011 <i>Lens for Sidemarker Lamp 40 123 011, 40 124 011, 40 125 011</i>		
40 129 001	10	Seitenmarkierungsleuchte mit Rückstrahler, 12V/24V <i>Sidemarker Lamp with reflex reflector, 12V/24V</i>		 SV 8,5 / C5W
40 129 021	10	Seitenmarkierungsleuchte mit Rückstrahler, flex. Pendelhalter nach hinten gerichtet, 12V/24V <i>Sidemarker Lamp with reflex reflector, flex. bracket 90° fitted to the back, 12V/24V</i>		 SV 8,5 / C5W
40 129 031	10	Seitenmarkierungsleuchte mit Rückstrahler, flex. Pendelhalter nach vorne gerichtet, 12V/24V <i>Sidemarker Lamp with reflex reflector, flex. bracket 90° fitted to the front, 12V/24V</i>		 SV 8,5 / C5W

Seitenmarkierungsleuchte

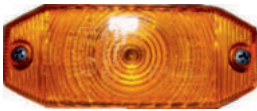
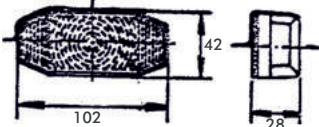
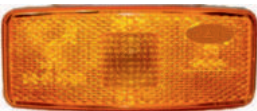
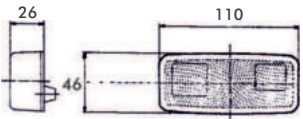
Sidemarker Lamp

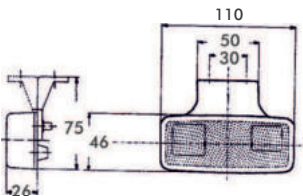
Artikel-Nr. Reference-No.	VE QTY	Beschreibung Description	Seitenmarkierungs- leuchten Sidemarker Lamps	
40 138 001	10	Seitenmarkierungsleuchte 12V/24V <i>Sidemarker Lamp 12V/24V</i>		SV 8,5 / C5W 
40 145 001	10	Seitenmarkierungsleuchte mit Rückstrahler 12V/24V <i>Sidemarker Lamp with reflex refelctor 12V/24V</i>		W2,1x9,5d / W5W 
40 145 101	10	Lichtscheibe für Seitenmarkierungsleuchte <i>Lens for Sidemarker Lamp</i>		
40 146 001	6	Seitenmarkierungsleuchte mit Rückstrahler, flex. Winkelhalter 12V/24V <i>Sidemarker Lamp with reflex refelctor, flex. bracket 90° 12V/24V</i>		W2,1x9,5d / W5W 
40 145 101	10	Lichtscheibe für Seitenmarkierungsleuchte <i>Lens for Sidemarker Lamp</i>		

LED Kennzeichenleuchten
Kennzeichenleuchten
LED Innenleuchten

LED Registration Plate Lamps
Registration Plate Lamps
LED Interior Lamps

5.0 - 5.3
5.4 - 5.5
5.6 - 5.25



LED Kennzeichenleuchte

LED Registration Plate Lamp

Typ: **PRO-REG**



Artikel-Nr. Reference-No.	VE QTY	Beschreibung Description	LED Kennzeichenleuchten LED Registration Plate Lamps	LED Technik LED Technology
40 027 044	2	LED Kennzeichenleuchte PRO-REG , modernes Design, Gehäuse schwarz, Kabel 0,5m, 12/24V Befestigung: Stehbolzen M5 <i>LED Registration Plate Lamp PRO-REG, modern design, black housing, cable 0,5m, 12/24V Fixation: 2 bolts M5</i>		
40 027 644	2	LED Kennzeichenleuchte PRO-REG , modernes Design, Gehäuse schwarz, Kabel 0,5m + P&R St., 12/24V Befestigung: Stehbolzen M5 <i>LED Registration Plate Lamp PRO-REG, modern design, black housing, 12/24V, cable 0,5m + P&R con. Fixation: 2 bolts M5</i>		
40 027 004	2	LED Kennzeichenleuchte PRO-REG , modernes Design, Gehäuse schwarz, Kabel 0,5m, 12/24V <i>LED Registration Plate Lamp PRO-REG, modern design, black housing, cable 0,5m, 12/24V</i>		
40 027 214	2	LED Kennzeichenleuchte PRO-REG , modernes Design, Gehäuse schwarz, Flachkabel 0,5m, 12/24V <i>LED Registration Plate Lamp PRO-REG, modern design, black housing, flat cable 0,5m, 12/24V</i>		

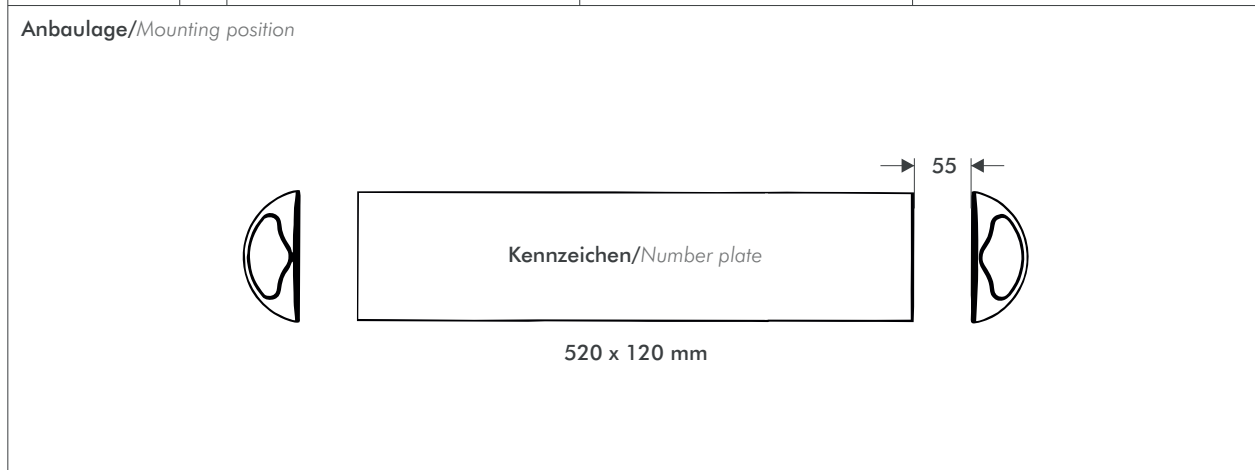

LED Kennzeichenleuchte

LED Registration Plate Lamp



Artikel-Nr. Reference-No.	VE QTY	Beschreibung Description	LED Kennzeichenleuchten LED Registration Plate Lamps	LED Technik LED Technology
NEW 40 072 004	1	<p>LED Kennzeichenleuchte PRO-REG II, kompakte Bauform, Gehäuse schwarz, Kabel 0,5m, 10-30V, ADR geprüft, ECE R10</p> <p>Besonderheit: Eine Kennzeichenleuchte für folgende Kennzeichengrößen: - 520mm x 120mm - 340mm x 240mm - 240mm x 165mm</p> <p>LED Registration Plate Lamp PRO-REG II, compact housing, cable 0,5m, bolt fixation, 10-30V</p> <p>Highlight: One Lamp for following sizes: - 520mm x 120mm - 340mm x 240mm - 240mm x 165mm</p>	 <p>ADR</p>	 <p>109, 35, 37, 72, M5</p>
			<p>Anbaulage/Mounting position</p>  <p>64, 520 x 120 mm, 30, 340 x 240 mm, 255 x 165 mm</p>	
40 205 508	2	<p>LED Kennzeichenleuchte schwarz, ADR Kabel 0,5m, 24V</p> <p>LED Registration Plate Lamp black, ADR cable 0,5m, 24V</p>		 <p>72, 99, 54, 57</p>
			<p>Anbaulage/Mounting position</p>  <p>55, 280, 30, 520 x 120 mm, 55, 340 x 240 mm</p>	
40 205 118	2	<p>Gehäusekappe schwarz black housing</p>		
40 165 404	2	<p>LED Kennzeichenleuchte schwarz, Kabel 0,5m, 12/24V, ADR geprüft</p> <p>LED Registration Plate Lamp black, cable 0,5m, 12/24V, ADR appr.</p>	 <p>ADR</p>	 <p>60, 78, 72, 100, 55</p>
			<p>Anbaulage/Mounting position</p>  <p>35, 520 x 120 mm, 270, 20, 520 x 120 mm</p>	
40 165 604	2	<p>LED Kennzeichenleuchte, dito, Kabel 0,5m + P&R Stecker</p> <p>LED Registration Plate Lamp, cable 0,5m + P&R connector</p>		

LED Kennzeichenleuchte





LED Registration Plate Lamp

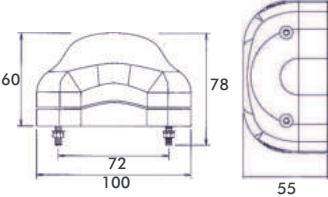
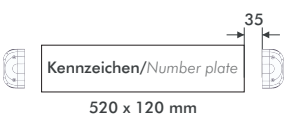

Artikel-Nr. Reference-No.	VE QTY	Beschreibung Description	LED Kennzeichenleuchten LED Registration Plate Lamps	LED Technik LED Technology
NEW 40 205 300 24V	1	LED Kennzeichenhalter PRO-CARRIER , mit 2 integr. LED Kennzeichenleuchten, SNAP-IN Verschluss einfache und schnelle Montage, Kabel 0,5m + P&R Stecker, 24V <i>LED License Plate Carrier PRO-CARRIER, with 2 integrated LED number plate lamps, quick and easy assembling (SNAP IN), cable 0,5m + P&R connector, 24V</i>		
NEW 40 008 004	2	LED Kennzeichenleuchte PRO-MINI-REG , extrem kleine Bauform, Gehäuse schwarz, Kabel 0,5m, Schraub- befestigung, 10-30V - 0,8W <i>LED Registration Plate Lamp PRO-MINI-REG, extrem compact housing, cable 0,5m, screw fixation, 10-30V - 0,8W</i>		 Anbaulage/Mounting position Kennzeichen/Number plate 520 x 120 mm
40 166 404	1	LED Kennzeichenleuchte kleine Ausführung, Flachkabel 0,5m, 12/24V <i>LED Registration Plate Lamp small version, flat cable 0,5m, 12/24V</i>		 Anbaulage/Mounting position Kennzeichen/Number plate 520 x 120 mm
40 114 004 24V	2	LED Kennzeichenleuchte für den Einbau, Kabel 0,5m, 24V <i>LED Registration Plate Lamp, cable 0,5m, recessed version, 24V</i>		
40 114 204 12V	2	LED Kennzeichenleuchte, 12V <i>LED Registration Plate Lamp, 12V</i>		 Kennzeichen/Number plate 520 x 120 mm
40 114 244 12V	2	LED Kennzeichenleuchte, 12V, Flachkabel 0,5m <i>LED Registration Plate Lamp, 12V, flat cable 0,5m</i>		 Kennzeichen/Number plate 520 x 120 mm
40 113 004 12V	2	LED Kennzeichenleuchte für den Einbau, Kabel 0,5m, 12V <i>LED Registration Plate Lamp, cable 0,5m, recessed version, 12V</i>		 Anbaulage/Mounting position Kennzeichen/Number plate 520 x 120 mm

Kennzeichenleuchte

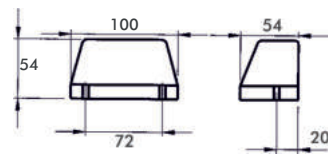
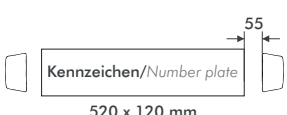
Registration Plate Lamp

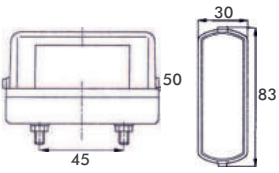
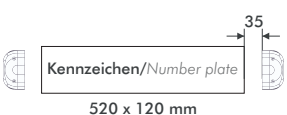
Artikel-Nr. Reference-No.	VE QTY	Beschreibung Description	Kennzeichenleuchten Registration Plate Lamps
40 165 004	2	Kennzeichenleuchte schwarz, Kabeleingang PG-Verschraubung 12V/24V <i>Registration Plate Lamp black, cable entrance PG-Screw 12V/24V</i>	 <p style="text-align: right;">SV 8,5 / C5W</p> 
36 300 403	2	Kennzeichenleuchte schwarz, Kabel 1,5m mit Aspöck P&R Stecker und Glühlampe 24V/5W <i>Registration Plate Lamp black, cable 1,5m with Aspöck P&R connector and bulb 24V/5W</i>	<p>Anbaulage/Mounting position</p> 
40 205 008	2	Kennzeichenleuchte schwarz, 12V/24V <i>Registration Plate Lamp black, 12V/24V</i>	<p style="text-align: right;">BA 15s / R5W</p>  
			<p>Anbaulage/Mounting position</p> 
40 166 004	2	Kennzeichenleuchte schwarz, kleine Ausführung 12V <i>Registration Plate Lamp black, small version 12V</i>	<p style="text-align: right;">SV 8,5 / C5W</p>  
			<p>Anbaulage/Mounting position</p> 

LED Schluß-/Kennzeichenleuchte

LED Rear-/Registration Plate Lamp



Artikel-Nr. Reference-No.	VE QTY	Beschreibung Description	Kennzeichenleuchten Registration Plate Lamps
40 027 544	2	<p>LED Schluß-Kennzeichenleuchte, PRO-REG, Funktionen Kennzeichenleuchte und Schlußlicht in LED-Technik, modernes Design, Kabel 0,5m, 12/24V, ADR gepr. Befestigung: Stehbolzen M5</p> <p><i>LED Rear-/Registration Plate Lamp PRO-REG, modern Design, cable 0,5m, 12/24V, ADR approved Fixation: 2 bolts M5</i></p>	 <p>Anbaulage/Mounting position</p> 
40 027 504 24V	2	<p>LED Schluß-Kennzeichenleuchte, PRO-REG, Funktionen Kennzeichenleuchte und Schlußlicht in LED-Technik, modernes Design, Kabel 0,5m, 12/24V, ADR gepr.</p> <p><i>LED Rear-/Registration Plate Lamp PRO-REG, modern Design, cable 0,5m, 12/24V, ADR approved</i></p>	 <p>Anbaulage/Mounting position</p> 
40 205 506 40 205 116	2 2	<p>LED Schluß-Kennzeichenleuchte, Funktionen Kennzeichenleuchte und Schlußlicht in LED-Technik, ADR-Kabel 0,5m, 24V</p> <p><i>LED Rear-/Registration Plate Lamp ADR cable 0,5m, 24V</i></p> <p>Lichtscheibe rot für LED Schluß-/Kennzeichenleuchte</p> <p><i>Lens red for LED Rear-/Registration Plate Lamp</i></p>	 <p>Anbaulage/Mounting position</p> 

Schluß-/Kennzeichenleuchte

Rear-/Registration Plate Lamp

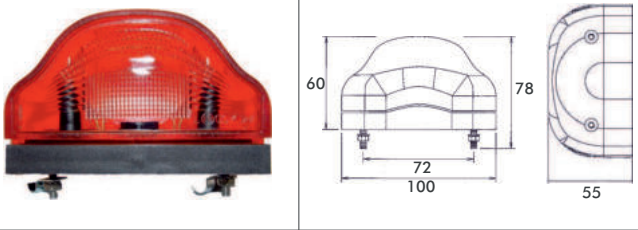
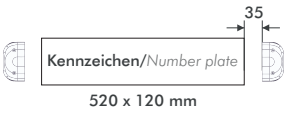
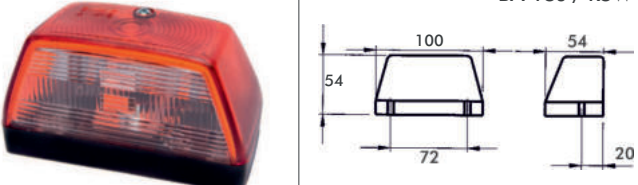
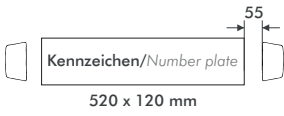
Artikel-Nr. Reference-No.	VE QTY	Beschreibung Description	Kennzeichenleuchten Registration Plate Lamps
40 182 004	2	Schluß-/Kennzeichenleuchte, Lichtscheibe rot, 12V/24V Rear-/Registration Plate Lamp, Lens red, 12V/24V	 <p style="text-align: right;">SV 8,5 / C5W</p>
40 182 104	2	Lichtscheibe rot für Schluß-/Kennzeichenleuchte Lens red for Rear-/Registration Plate Lamp	
			<p>Anbaulage/Mounting position</p>  <p style="text-align: center;">520 x 120 mm</p>
40 205 006	2	Schluß-/Kennzeichenleuchte, Lichtscheibe rot, 12V/24V Rear-/Registration Plate Lamp, Lens red, 12V/24V	 <p style="text-align: right;">BA 15s / R5W</p>
40 205 106	2	Lichtscheibe rot für Schluß-/Kennzeichenleuchte Lens red for Rear-/Registration Plate Lamp	
			<p>Anbaulage/Mounting position</p>  <p style="text-align: center;">520 x 120 mm</p>

LED Innenleuchte

LED Interior Lamp

Typ: **PRO-ZONE**

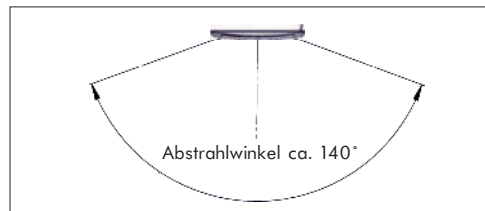

Artikel-Nr. Reference-No.	VE QTY	Beschreibung Description	LED Innenleuchten LED Interior Lamps	LED Technik LED Technology
40 056 003	1	<p>LED Innenleuchte PRO-ZONE, homogene, blendfreie Ausleuchtung dank opaler Lichtaustrittsscheibe, besonders flach aufbauend, Höhe 14,5mm, Kunststoffgehäuse, ADR-gepr., IP6K9K, 12/24V Anschluss: Flachkabel 0,3m</p> <p><i>LED Interior Lamp PRO-ZONE, homogeneous, glare-free illumination thanks to the lens in opal optic, very low profile, height 14,5mm, plastic housing, ADR-appr., IP6K9K, 12/24V Connection: flat cable 0,3m</i></p>	<p>900lm</p>	<p>blendfreie Ausleuchtung glare-free illumination</p>
40 056 043	1	<p>LED Innenleuchte PRO-ZONE, mit Sensor-Touch Schalter, homogene, blendfreie Ausleuchtung dank opaler Lichtaustrittsscheibe, besonders flach aufbauend, Höhe 14,5mm, Kunststoffgehäuse, ADR-gepr., IP6K9K, 12/24V Anschluss: Flachkabel 0,3m</p> <p><i>LED Interior Lamp PRO-ZONE, with Sensor-Touch switch, homogeneous, glare-free illumination thanks to the lens in opal optic, very low profile, height 14,5mm, plastic housing, ADR-appr., IP6K9K, 12/24V Connection: flat cable 0,3m</i></p>	<p>900lm</p> <p>Sensor-Touch Schalter</p>	<p>blendfreie Ausleuchtung glare-free illumination</p>
40 056 073 24V	1	<p>LED Innenleuchte PRO-ZONE, mit Bewegungssensor, homogene, blendfreie Ausleuchtung dank opaler Lichtaustrittsscheibe, besonders flach aufbauend, Höhe 14,5mm, Kunststoffgehäuse mit Kabel 0,3m, ADR-gepr., IP6K9K, 24V</p> <p><i>LED Interior Lamp PRO-ZONE, with Motion sensor, homogeneous, glare-free illumination thanks to the lens in opal optic, very low profile, height 14,5mm, plastic housing with cable 0,3m, ADR-appr., IP6K9K, 24V</i></p>	<p>550lm</p>	<p>blendfreie Ausleuchtung glare-free illumination</p> <p>Anschlusskabel 2 x 0,5mm²</p>
40 056 273 12V	1	<p>LED Innenleuchte PRO-ZONE, dito., 12V</p> <p><i>LED Interior Lamp PRO-ZONE, 12V</i></p>	<p>Bewegungssensor</p>	

LED Innenleuchte

LED Interior Lamp

Typ: **PRO-ROOF**

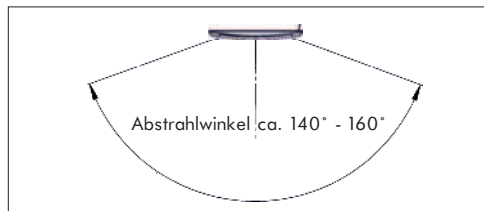

Artikel-Nr. Reference-No.	VE QTY	Beschreibung Description	LED Innenleuchten LED Interior Lamps	LED Technik 12V/24V LED Technology 12V/24V
40 037 023	1	<p>LED Innenleuchte PRO-S-ROOF, 18 Hochleistungs-LED's mit brillianter Spiegeltechnik, Kunststoffgehäuse, Aufbauversion, 12/24V, IP6K9K Anschluss: Flachkabel 0,5m</p> <p><i>LED Interior Lamp PRO-S-ROOF, 18 High Power LED's, plastic housing, pendant version, 12/24V, IP6K9K Connection: flat cable 0,5m</i></p>	<p>900lm</p>	<p>Aufbau Pendant</p>
40 037 033	1	<p>LED Innenleuchte PRO-S-ROOF, dito, Einbauversion</p> <p><i>LED Interior Lamp PRO-S-ROOF, recessed version</i></p>		<p>Kabel 0,5m</p>
40 037 003	1	<p>LED Innenleuchte PRO-ROOF, 18 Hochleistungs-LED's mit brillianter Spiegeltechnik, Kunststoffgehäuse, Aufbauversion, 12/24V, IP6K9K Anschluss: Flachkabel 0,5m</p> <p><i>LED Interior Lamp PRO-ROOF, 18 High Power LED's, plastic housing, pendant version, 12/24V, IP6K9K Connection: flat cable 0,5m</i></p>	<p>360lm</p>	
40 037 013	1	<p>LED Innenleuchte PRO-ROOF, Einbauversion</p> <p><i>LED Interior Lamp PRO-ROOF, recessed version</i></p>		<p>Einbau Recessed</p>
40 037 043	1	<p>LED Innenleuchte PRO-S-ROOF opal, 18 Hochleistungs-LED's, weiche, homogene Ausleuchtung, Kunststoffgehäuse, Aufbauversion, 12/24V, IP6K9K Anschluss: Flachkabel 0,5m</p> <p><i>LED Interior Lamp PRO-S-ROOF opal, 18 High Power LED's, soft, homogeneous illumination, plastic housing, pendant version, 12/24V, IP6K9K Connection: flat cable 0,5m</i></p>	<p>700lm</p>	
40 037 053	1	<p>LED Innenleuchte PRO-S-ROOF opal, Einbauversion</p> <p><i>LED Interior Lamp PRO-S-ROOF opal, recessed version</i></p>	<p>blendfreie Ausleuchtung glare-free illumination</p>	<p>Kabel 0,5m</p>

LED Innenleuchte

LED Interior Lamp

Typ: **PRO-SPACE**

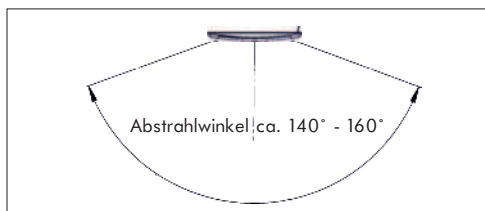

Artikel-Nr. Reference-No.	VE QTY	Beschreibung Description	LED Innenleuchten LED Interior Lamps	LED Technik 12V/24V LED Technology 12V/24V
40 047 023	1	LED Innenleuchte PRO-S-SPACE , 18 Hochleistungs-LED`s mit brillanter Spiegeltechnik, Kunststoffgehäuse, Aufbauversion, 12/24V, IP6K9K Anschluss: Flachkabel 0,5m <i>LED Interior Lamp PRO-S-SPACE, 18 High Power LED`s, plastic housing, pendant version, 12/24V, IP6K9K Connection: flat cable 0,5m</i>	900lm 	Aufbau Pendant
40 047 033	1	LED Innenleuchte PRO-S-SPACE , Einbauversion <i>LED Interior Lamp PRO-S-SPACE, recessed version</i>		
40 047 003	1	LED Innenleuchte PRO-SPACE , 18 Hochleistungs-LED`s mit brillanter Spiegeltechnik, Kunststoffgehäuse, Aufbauversion, 12/24V, IP6K9K Anschluss: Flachkabel 0,5m <i>LED Interior Lamp PRO-SPACE, 18 High Power LED`s, plastic housing, pendant version, 12/24V, IP6K9K Connection: flat cable 0,5m</i>	360lm 	
40 047 013	1	LED Innenleuchte PRO-SPACE , Einbauversion <i>LED Interior Lamp PRO-SPACE, recessed version</i>		Einbau Recessed
40 047 043	1	LED Innenleuchte PRO-S-SPACE opal , 18 Hochleistungs-LED`s, weiche, homogene Ausleuchtung, Kunststoffgehäuse, Aufbauversion, 12/24V, IP6K9K Anschluss: Flachkabel 0,5m <i>LED Interior Lamp PRO-S-SPACE opal, 18 High Power LED`s, soft, homogeneous illumination, plastic housing, pendant version, 12/24V, IP6K9K Connection: flat cable 0,5m</i>	700lm 	
40 047 053	1	LED Innenleuchte PRO-S-SPACE opal , Einbauversion <i>LED Interior Lamp PRO-S-SPACE opal, recessed version</i>	 blendfreie Ausleuchtung glare-free illumination	

LED Innenleuchte

LED Interior Lamp

Typ: **PRO-MINI-SPACE**











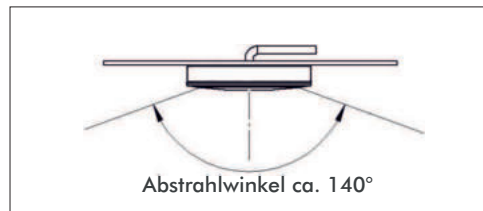

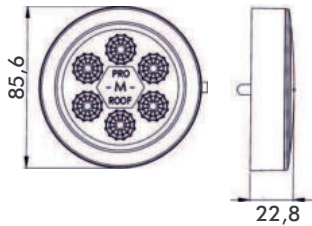

Artikel-Nr. Reference-No.	VE QTY	Beschreibung Description	LED Innenleuchten LED Interior Lamps	LED Technik 12V/24V LED Technology 12V/24V
40 068 003	1	<p>LED Innenleuchte PRO-MINI-SPACE 6 Hochleistungs-LED's mit verspiegelter Abdeckung, Kunststoffgehäuse, Aufbauversion, 12/24V, IP6K9K Anschluss: Flachkabel 0,5m</p> <p><i>LED Interior Lamp PRO-MINI-SPACE 6 High Power LED's, plastic housing, pendant version, 12/24V, IP6K9K Connection: flat cable 0,5m</i></p>	<p>550lm</p>	
40 068 043	1	<p>LED Innenleuchte PRO-MINI-SPACE mit Sensor-Touch Schalter, 6 Hochleistungs-LED's mit verspiegelter Abdeckung, Kunststoffgehäuse, Aufbauversion, 12/24V, IP6K9K Anschluss: Flachkabel 0,5m</p> <p><i>LED Interior Lamp PRO-MINI-SPACE with Sensor-Touch switch, 6 High Power LED's, plastic housing, pendant version, 12/24V, IP6K9K Connection: flat cable 0,5m</i></p>	<p>550lm</p>	

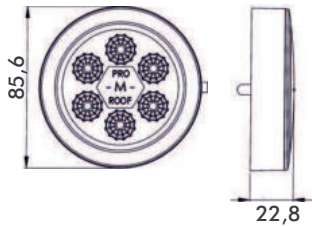
LED Innenleuchte

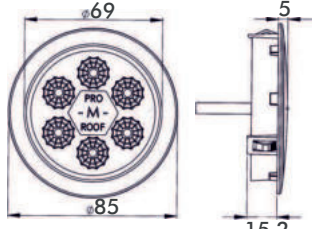
LED Interior Lamp

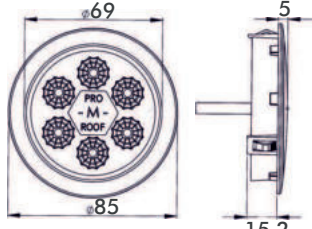
Typ: **PRO-MINI-ROOF**

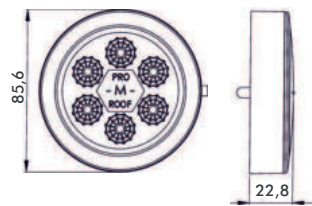

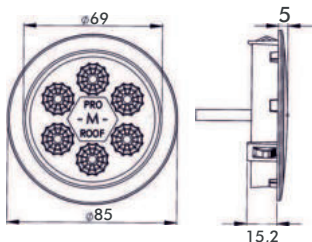
Artikel-Nr. Reference-No.	VE QTY	Beschreibung Description	LED Innenleuchten LED Interior Lamps	LED Technik LED Technology
40 046 003 24V	1	LED Innenleuchte PRO-M-ROOF , 6 Hochleistungs-LED`s mit brillianter Spiegeltechnik, Kunststoffgehäuse, Aufbauversion, 24V, IP6K9K Anschluss: Flachkabel 0,5m <i>LED Interior Lamp PRO-M-ROOF, 6 High Power LED`s, plastic housing, pendant version, 24V, IP6K9K Connection: flat cable 0,5m</i>	280lm 	
40 046 203 12V	1	LED Innenleuchte PRO-M-ROOF , dito., 12V <i>LED Interior Lamp PRO-M-ROOF, 12V</i>		
40 046 013 24V	1	LED Innenleuchte PRO-M-ROOF , 6 Hochleistungs-LED`s mit brillianter Spiegeltechnik, Kunststoffgehäuse, Einbauversion, 24V, IP6K9K Anschluss: Flachkabel 0,5m <i>LED Interior Lamp PRO-M-ROOF, 6 High Power LED`s, plastic housing, recessed version, 24V, IP6K9K Connection: flat cable 0,5m</i>	280lm 	
40 046 213 12V	1	LED Innenleuchte PRO-M-ROOF , dito., 12V <i>LED Interior Lamp PRO-M-ROOF, 12V</i>		
40 046 903 12V	1	LED Innenleuchte PRO-M-ROOF , 6 Hochleistungs-warmlicht LED`s mit brillianter Spiegeltechnik, Kunststoffgehäuse, Aufbauversion, 12V, IP6K9K Anschluss: Flachkabel 0,5m <i>LED Interior Lamp PRO-M-ROOF, 6 High Power warmlight LED`s, plastic housing, pendant version, 12V, IP6K9K Connection: flat cable 0,5m</i>	260lm 	warmlicht warmlight 
40 046 913 12V	1	LED Innenleuchte PRO-M-ROOF , 6 Hochleistungs-warmlicht LED`s mit brillianter Spiegeltechnik, Kunststoffgehäuse, Einbauversion, 12V, IP6K9K Anschluss: Flachkabel 0,5m <i>LED Interior Lamp PRO-M-ROOF, 6 High Power warmlight LED`s, plastic housing, recessed version, 12V, IP6K9K Connection: flat cable 0,5m</i>	260lm 	warmlicht warmlight 

Innenleuchte

Interior Lamp

Typ: **PRO-STEP**
PRO-IN
PRO-STRIPE ECO



Artikel-Nr. Reference-No.	VE QTY	Beschreibung Description	LED Innenleuchten LED Interior Lamps	LED Technik LED Technology
NEW 40 475 003	1	LED Innenleuchte PRO-STEP , 3 Power-LED's, Lichtaustritt weiß, Aluminiumdruckguss Gehäuse, wasserdicht vergossen, 12/24V, IP67 Anschluss: Kabel 0,5m <i>LED Interior Lamp PRO-STEP, 3 power LEDs, white illumination, aluminium die cast housing, lamp complete potted, 12/24V, IP67 Connection: cable 0,5m</i>	650lm EMC	
40 035 003 24V	1	LED Innenleuchte PRO-IN , 18 Hochleistungs-LED's, Lichtaustritt weiß, wasserdichtes, komplett vergossenes Gehäuse, 24V, IP67 Anschluss: Flachkabel 0,5m <i>LED Interior Lamp PRO-IN, 18 high power LEDs, white illumination, housing complete potted, 24V, IP67 Connection: flat cable 0,5m</i>	250lm 	
40 035 203 12V	1	LED Innenleuchte PRO-IN , dito., 12V <i>LED Interior Lamp PRO-IN, 12V</i>	 ADR	
40 048 085 24V	1	LED Innenleuchte PRO-STRIPE ECO 1 blue , 222mm, 18 POWER- LED's, Kabel 0,3m, Schnell- befestigung mit Selbstklebefolie, IP6K9K gepr., ADR, 24V/2,2W <i>LED Interior Lamp PRO-STRIPE ECO 1 blue, 222mm, 18 POWER- LED's, cabel 0,3m, quick fixation with adhesive pad, IP6K9K appr., ADR, 24V/2,2W</i>	 ADR	 Leuchte in Funktion/Lamp in function
40 048 000	1	Befestigungskit PRO-STRIPE ECO inkl. Schrauben <i>Mounting Kit PRO-STRIPE ECO incl. screws</i>		
40 048 100	1	Befestigungskit PRO-STRIPE ECO mit Kabelausbrüchen, inkl. Schrauben <i>Mounting Kit PRO-STRIPE ECO with cable outbreaks, incl. screws</i>	 40 48 000	 mit Kabelausbrüchen/ with cable outbreaks 40 48 100

LED Innenleuchte

LED Interior Lamp

Typ: Zentraler PIR-Sensor



Anschlussmöglichkeit mit Zentral PIR-Sensor

Fitting possibilities with Central PIR-Sensor

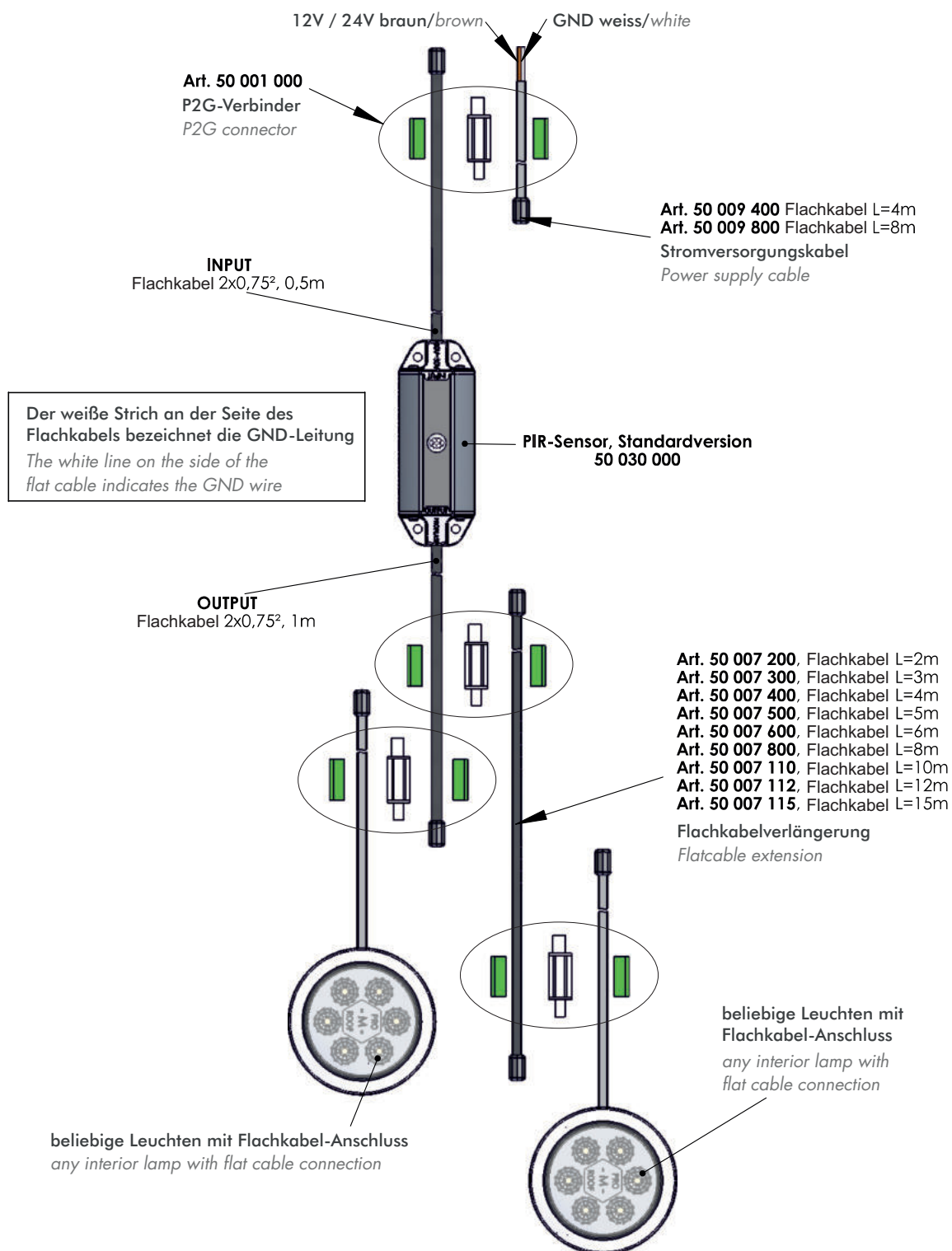

LED Innenleuchte

LED Interior Lamp

Typ: Zentral PIR-Sensor



Artikel-Nr. Reference-No.	VE QTY	Beschreibung Description	LED Innenleuchten LED Interior Lamps
50 030 000	1	Zentraler PIR-Sensor, Flachkabel 2 x 0,75mm ² : - Eingang 0,5m - Ausgang 1,0m Anschluss von Leuchten bis 5A, 10-30V, Umgebungstemperatur -30°C - 30°C, IP6K9K <i>Central PIR-Sensor, Flat cable 2 x 0,75mm²: - Input 0,5m - Output 1,0m connection of lamps up to 5 A, 10-30V, ambient temperature -30°C - 30°C, IP6K9K</i>	
50 007 200	1	Flachkabelverlängerung 2m 2x0,75mm ² <i>Flat cable extension 2m 2x0,75mm²</i>	<p>Verlängerungskabel für Einzelfunktionsleuchten, Endkappen beidseitig</p> <p>weitere Kabellängen finden Sie auf Seite 9.6</p> <p><i>extension for single function lamps both sides with end caps</i></p> <p>for further cable lengths, please refer to page 9.6</p>
50 007 400	1	Flachkabelverlängerung 4m 2x0,75mm ² <i>Flat cable extension 4m 2x0,75mm²</i>	
50 007 600	1	Flachkabelverlängerung 6m 2x0,75mm ² <i>Flat cable extension 6m 2x0,75mm²</i>	
50 007 800	1	Flachkabelverlängerung 8m 2x0,75mm ² <i>Flat cable extension 8m 2x0,75mm²</i>	<p>Verlängerungskabel für Einzelfunktionsleuchten, Endkappen beidseitig</p> <p>weitere Kabellängen finden Sie auf Seite 9.6</p> <p><i>extension for single function lamps both sides with end caps</i></p> <p>for further cable lengths, please refer to page 9.6</p>
50 007 112	1	Flachkabelverlängerung 12m 2x0,75mm ² <i>Flat cable extension 12m 2x0,75mm²</i>	
50 007 115	1	Flachkabelverlängerung 15m 2x0,75mm ² <i>Flat cable extension 15m 2x0,75mm²</i>	
50 009 400	1	Stromversorgungskabel für PIR- Sensor, Flachkabel 4m 2x0,75mm ² <i>Power supply cable for PIR-Sensor, flat cable 4m 2x0,75mm²</i>	<p>eine Seite mit Endkappe, andere Seite open end</p> <p><i>one side with end cap, other side open end</i></p>
50 009 800	1	Stromversorgungskabel für PIR- Sensor, dito., Flachkabel 8m <i>Power supply cable for PIR-Sensor, flat cable 8m</i>	
50 001 000	10	P2G-Verbinder für die elektrische Verbindung von 2 Flachkabeln <i>P2G connector for flat cable 2x0,75</i>	

LED Innenleuchte

LED Interior Lamp

Typ: **PRO-TWIN-STRIPE**



Artikel-Nr. Reference-No.	VE QTY	LED Innenleuchte PRO-TWIN-STRIPE - 36 - 192 Power-LED´s - 620 - 3500 Lumen - Aluminiumgehäuse - Kabel 0,3m - Aufbauversion - IP6K9K - 130° Abstrahlwinkel	LED Interior Lamp PRO-TWIN-STRIPE - 36 - 192 power LED´s - 620 - 3500 Lumen - Aluminium housing - Cable 0,3m - Pendant version - IP6K9K - 130° light output angle			
40 064 003	1	24V	620lm	Länge/Length: 305mm	Breite/Width: 64mm	Höhe/Height: 15mm
40 064 203	1	12V	620lm	Länge/Length: 305mm	Breite/Width: 64mm	Höhe/Height: 15mm
40 064 013	1	24V	1650lm	Länge/Length: 610mm	Breite/Width: 64mm	Höhe/Height: 15mm
40 064 213	1	12V	1650lm	Länge/Length: 610mm	Breite/Width: 64mm	Höhe/Height: 15mm
40 064 023	1	24V	2600lm	Länge/Length: 915mm	Breite/Width: 64mm	Höhe/Height: 15mm
40 064 223	1	12V	2600lm	Länge/Length: 915mm	Breite/Width: 64mm	Höhe/Height: 15mm
40 064 033	1	24V	3500lm	Länge/Length: 1220mm	Breite/Width: 64mm	Höhe/Height: 15mm
40 064 233	1	12V	3500lm	Länge/Length: 1220mm	Breite/Width: 64mm	Höhe/Height: 15mm

--	--



LED Innenleuchte

LED Interior Lamp

Typ: PRO-TWIN-STRIPE
mit **Schalter**/with *Switch*



Schalter/on-off switch

Artikel-Nr. Reference-No.	VE QTY	LED Innenleuchte PRO-TWIN-STRIPE - 36 - 96 Power-LED´s - 620 - 1650 Lumen - Aluminiumgehäuse - Kabel 0,3m - Aufbauversion - IP6K9K - 130° Abstrahlwinkel	LED Interior Lamp PRO-TWIN-STRIPE - 36 - 96 power LED´s - 620 - 1650 Lumen - Aluminium housing - Cable 0,3m - Pendant version - IP6K9K - 130° light output angle
40 064 043	1	24V 620lm	Länge/Length: 305mm Breite/Width: 64mm Höhe/Height: 15mm
40 064 243	1	12V 620lm	Länge/Length: 305mm Breite/Width: 64mm Höhe/Height: 15mm
40 064 053	1	24V 1650lm	Länge/Length: 610mm Breite/Width: 64mm Höhe/Height: 15mm
40 064 253	1	12V 1650lm	Länge/Length: 610mm Breite/Width: 64mm Höhe/Height: 15mm

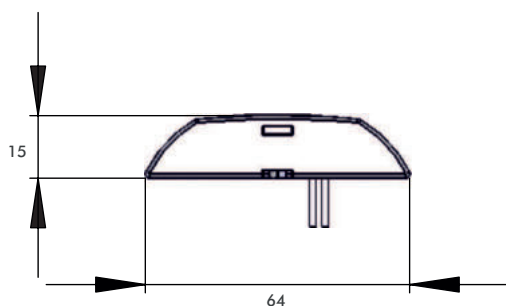

LED Innenleuchte

LED Interior Lamp

Typ: **PRO-TWIN-STRIPE ECO**



Artikel-Nr. Reference-No.	VE QTY	LED Innenleuchte PRO-TWIN-STRIPE ECO - 36 - 192 Power-LED´s - 620 - 3500 Lumen - Aluminiumgehäuse - Kabel 0,3m - Aufbauversion - IP6K9K - 130° Abstrahlwinkel	LED Interior Lamp PRO-TWIN-STRIPE ECO - 36 - 192 power LED´s - 620 - 3500 Lumen - Aluminium housing - Cable 0,3m - Pendant version - IP6K9K - 130° light output angle
40 064 083	1	24V 620lm	Länge/Length: 305mm Breite/Width: 42,4mm Höhe/Height: 15mm
40 064 283	1	12V 620lm	Länge/Length: 305mm Breite/Width: 42,4mm Höhe/Height: 15mm
40 064 093	1	24V 1650lm	Länge/Length: 610mm Breite/Width: 42,4mm Höhe/Height: 15mm
40 064 293	1	12V 1650lm	Länge/Length: 610mm Breite/Width: 42,4mm Höhe/Height: 15mm
40 064 323	1	24V 2600lm	Länge/Length: 915mm Breite/Width: 42,4mm Höhe/Height: 15mm
40 064 423	1	12V 2600lm	Länge/Length: 915mm Breite/Width: 42,4mm Höhe/Height: 15mm
40 064 333	1	24V 3500lm	Länge/Length: 1220mm Breite/Width: 42,4mm Höhe/Height: 15mm
40 064 433	1	12V 3500lm	Länge/Length: 1220mm Breite/Width: 42,4mm Höhe/Height: 15mm

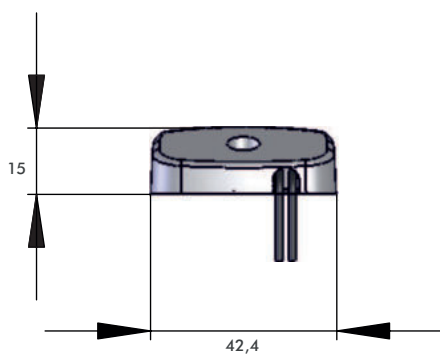

LED Innenleuchte

LED Interior Lamp

Typ: **PRO-STRIPE**



Artikel-Nr. Reference-No.	VE QTY	LED Innenleuchte PRO-STRIPE - 18 - 108 Power-LED´s - 280 - 1650 Lumen - Aluminiumgehäuse - Kabel 0,3m - Aufbauversion - IP6K9K - 130° Abstrahlwinkel	LED Interior Lamp PRO-STRIPE - 18 - 108 power LED´s - 280 - 1650 Lumen - Aluminium housing - Cable 0,3m - Pendant version - IP6K9K - 130° light output angle
40 048 003	1	24V 280lm	Länge/Length: 305mm Breite/Width: 44mm Höhe/Height: 15mm
40 048 203	1	12V 280lm	Länge/Length: 305mm Breite/Width: 44mm Höhe/Height: 15mm
40 048 013	1	24V 740lm	Länge/Length: 610mm Breite/Width: 44mm Höhe/Height: 15mm
40 048 213	1	12V 740lm	Länge/Length: 610mm Breite/Width: 44mm Höhe/Height: 15mm
40 048 023	1	24V 1200lm	Länge/Length: 915mm Breite/Width: 44mm Höhe/Height: 15mm
40 048 223	1	12V 1200lm	Länge/Length: 915mm Breite/Width: 44mm Höhe/Height: 15mm
40 048 033	1	24V 1650lm	Länge/Length: 1220mm Breite/Width: 44mm Höhe/Height: 15mm
40 048 233	1	12V 1650lm	Länge/Length: 1220mm Breite/Width: 44mm Höhe/Height: 15mm

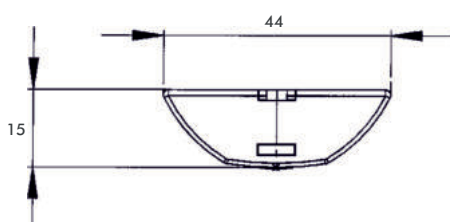

LED Innenleuchte

LED Interior Lamp

Typ: PRO-STRIPE
 mit Schalter/*with Switch*



Artikel-Nr. Reference-No.	VE QTY	LED Innenleuchte PRO-STRIPE	LED Interior Lamp PRO-STRIPE
		- 18 - 108 Power-LED´s - 280 - 1650 Lumen - Aluminiumgehäuse - Kabel 0,3m - Aufbauversion - IP6K9K - 130° Abstrahlwinkel	- 18 - 108 power LED´s - 280 - 1650 Lumen - Aluminium housing - Cable 0,3m - Pendant version - IP6K9K - 130° light output angle
40 048 043	1	24V 280lm	Länge/Length: 305mm Breite/Width: 44mm Höhe/Height: 15mm
40 048 243	1	12V 280lm	Länge/Length: 305mm Breite/Width: 44mm Höhe/Height: 15mm
40 048 053	1	24V 740lm	Länge/Length: 610mm Breite/Width: 44mm Höhe/Height: 15mm
40 048 253	1	12V 740lm	Länge/Length: 610mm Breite/Width: 44mm Höhe/Height: 15mm
40 048 063	1	24V 1200lm	Länge/Length: 915mm Breite/Width: 44mm Höhe/Height: 15mm
40 048 263	1	12V 1200lm	Länge/Length: 915mm Breite/Width: 44mm Höhe/Height: 15mm
40 048 073	1	24V 1650lm	Länge/Length: 1220mm Breite/Width: 44mm Höhe/Height: 15mm
40 048 273	1	12V 1650lm	Länge/Length: 1220mm Breite/Width: 44mm Höhe/Height: 15mm

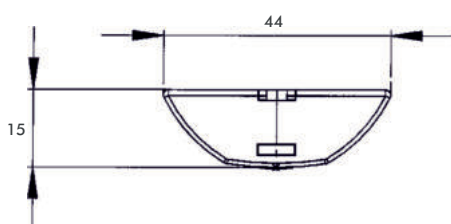

LED Innenleuchte

LED Interior Lamp

Typ: PRO-STRIPE
 mit Bewegungsmelder/Motion Sensor



Bewegungsmelder/motion sensor

Artikel-Nr. Reference-No.	VE QTY	LED Innenleuchte PRO-STRIPE	LED Interior Lamp PRO-STRIPE
		- 18 - 108 Power-LED´s - 170 - 1030 Lumen - Aluminiumgehäuse - Kabel 0,3m - Aufbauversion - IP6K9K - 130° Abstrahlwinkel	- 18 - 108 power LED´s - 170 - 1030 Lumen - Aluminium housing - Cable 0,3m - Pendant version - IP6K9K - 130° light output angle
40 048 603	1	24V 170lm	Länge/Length: 305mm Breite/Width: 44mm Höhe/Height: 15mm
40 048 703	1	12V 170lm	Länge/Length: 305mm Breite/Width: 44mm Höhe/Height: 15mm
40 048 613	1	24V 450lm	Länge/Length: 610mm Breite/Width: 44mm Höhe/Height: 15mm
40 048 713	1	12V 450lm	Länge/Length: 610mm Breite/Width: 44mm Höhe/Height: 15mm
40 048 623	1	24V 740lm	Länge/Length: 915mm Breite/Width: 44mm Höhe/Height: 15mm
40 048 723	1	12V 740lm	Länge/Length: 915mm Breite/Width: 44mm Höhe/Height: 15mm
40 048 633	1	24V 1030lm	Länge/Length: 1220mm Breite/Width: 44mm Höhe/Height: 15mm
40 048 733	1	12V 1030lm	Länge/Length: 1220mm Breite/Width: 44mm Höhe/Height: 15mm

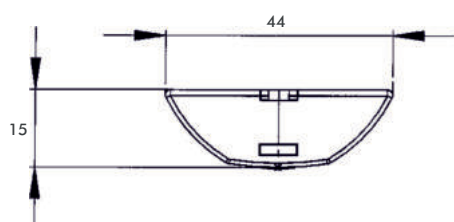

LED Innenleuchte

LED Interior Lamp

Typ: **PRO-STRIPE ECO**
mit **Schalter**/with *Switch*



Schalter/on-off switch

Artikel-Nr. Reference-No.	VE QTY	LED Innenleuchte PRO-TWIN-STRIPE ECO - 18 - 48 Power-LED´s - 280 - 740 Lumen - Aluminiumgehäuse - Kabel 0,3m - Aufbauversion - IP6K9K - 130° Abstrahlwinkel	LED Interior Lamp PRO-TWIN-STRIPE ECO - 18 - 48 power LED´s - 280 - 740 Lumen - Aluminium housing - Cable 0,3m - Pendant version - IP6K9K - 130° light output angle
40 048 183	1	24V 280lm	Länge/Length: 297mm Breite/Width: 23mm Höhe/Height: 14,7mm
40 048 383	1	12V 280lm	Länge/Length: 297mm Breite/Width: 23mm Höhe/Height: 14,7mm
40 048 193	1	24V 740lm	Länge/Length: 602mm Breite/Width: 23mm Höhe/Height: 14,7mm
40 048 393	1	12V 740lm	Länge/Length: 602mm Breite/Width: 23mm Höhe/Height: 14,7mm

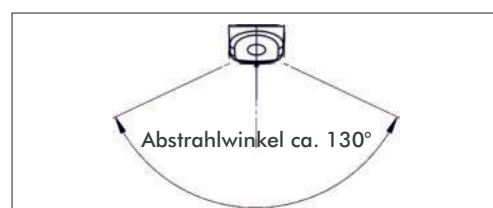
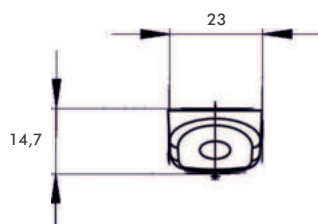

LED Umfeldleuchte

LED Scenelite

Typ: PRO-TWIN-WALL



Artikel-Nr. Reference-No.	VE QTY	LED Umfeldleuchte für Außen- und Innenbereich PRO-TWIN-WALL - 36 - 192 Power-LED´s - 620 - 3500 Lumen - Aluminiumgehäuse - Kabel 0,3m - Aufbauversion - IP6K9K - 130° Abstrahlwinkel	LED Scenelite for Outdoor- and Inner area PRO-TWIN-WALL - 36 - 192 power LED´s - 620 - 3500 Lumen - Aluminium housing - Cable 0,3m - Pendant version - IP6K9K - 130° light output angle
40 066 003	1	24V 620lm Länge/Length: 305mm	Breite/Width: 46,9mm Höhe/Height: 58mm
40 066 203	1	12V 620lm Länge/Length: 305mm	Breite/Width: 46,9mm Höhe/Height: 58mm
40 066 013	1	24V 1650lm Länge/Length: 610mm	Breite/Width: 46,9mm Höhe/Height: 58mm
40 066 213	1	12V 1650lm Länge/Length: 610mm	Breite/Width: 46,9mm Höhe/Height: 58mm
40 066 023	1	24V 2600lm Länge/Length: 915mm	Breite/Width: 46,9mm Höhe/Height: 58mm
40 066 223	1	12V 2600lm Länge/Length: 915mm	Breite/Width: 46,9mm Höhe/Height: 58mm
40 066 033	1	24V 3500lm Länge/Length: 1220mm	Breite/Width: 46,9mm Höhe/Height: 58mm
40 066 233	1	12V 3500lm Länge/Length: 1220mm	Breite/Width: 46,9mm Höhe/Height: 58mm

	<p>Abstrahlwinkel ca. 130°</p>
--	--------------------------------

LED Umfeldleuchte

LED Scenelite

Typ: PRO-WALL



Artikel-Nr. Reference-No.	VE QTY	LED Umfeldleuchte für Außen- und Innenbereich PRO-WALL - 18 - 108 Power-LED´s - 280 - 1650 Lumen - Aluminiumgehäuse - Kabel 0,3m - Aufbauversion - IP6K9K - 130° Abstrahlwinkel	LED Scenelite for Outdoor- and Inner area PRO-WALL - 18 - 108 power LED´s - 280 - 1650 Lumen - Aluminium housing - Cable 0,3m - Pendant version - IP6K9K - 130° light output angle
40 060 003	1	24V 280lm	Länge/Length: 268mm Breite/Width: 36,7mm Höhe/Height: 44,2mm
40 060 203	1	12V 280lm	Länge/Length: 268mm Breite/Width: 36,7mm Höhe/Height: 44,2mm
40 060 013	1	24V 740lm	Länge/Length: 573mm Breite/Width: 36,7mm Höhe/Height: 44,2mm
40 060 213	1	12V 740lm	Länge/Length: 573mm Breite/Width: 36,7mm Höhe/Height: 44,2mm
40 060 023	1	24V 1200lm	Länge/Length: 878mm Breite/Width: 36,7mm Höhe/Height: 44,2mm
40 060 223	1	12V 1200lm	Länge/Length: 878mm Breite/Width: 36,7mm Höhe/Height: 44,2mm
40 060 033	1	24V 1650lm	Länge/Length: 1183mm Breite/Width: 36,7mm Höhe/Height: 44,2mm
40 060 233	1	12V 1650lm	Länge/Length: 1183mm Breite/Width: 36,7mm Höhe/Height: 44,2mm

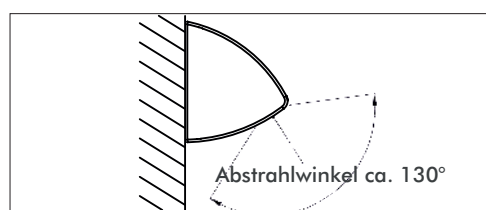
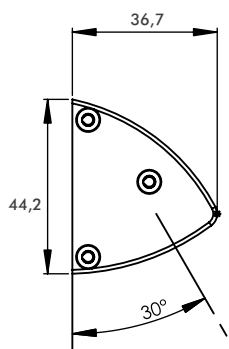

LED Umfundleuchte

LED Scenelite

Typ: **PRO-WALL**
mit **Schalter**/with *Switch*



Schalter/on-off switch

Artikel-Nr. Reference-No.	VE QTY	LED Umfundleuchte für Außen- und Innenbereich PRO-WALL - 18 - 108 Power-LED´s - 280 - 1650 Lumen - Aluminiumgehäuse - Kabel 0,3m - Aufbauversion - IP6K9K - 130° Abstrahlwinkel	LED Scenelite for Outdoor- and Inner area PRO-WALL - 18 - 108 power LED´s - 280 - 1650 Lumen - Aluminium housing - Cable 0,3m - Pendant version - IP6K9K - 130° light output angle
40 060 043	1	24V 280lm Länge/Length: 268mm	Breite/Width: 36,7mm Höhe/Height: 44,2mm
40 060 243	1	12V 280lm Länge/Length: 268mm	Breite/Width: 36,7mm Höhe/Height: 44,2mm
40 060 053	1	24V 740lm Länge/Length: 573mm	Breite/Width: 36,7mm Höhe/Height: 44,2mm
40 060 253	1	12V 740lm Länge/Length: 573mm	Breite/Width: 36,7mm Höhe/Height: 44,2mm
40 060 063	1	24V 1200lm Länge/Length: 878mm	Breite/Width: 36,7mm Höhe/Height: 44,2mm
40 060 263	1	12V 1200lm Länge/Length: 878mm	Breite/Width: 36,7mm Höhe/Height: 44,2mm
40 060 073	1	24V 1650lm Länge/Length: 1183mm	Breite/Width: 36,7mm Höhe/Height: 44,2mm
40 060 273	1	12V 1650lm Länge/Length: 1183mm	Breite/Width: 36,7mm Höhe/Height: 44,2mm

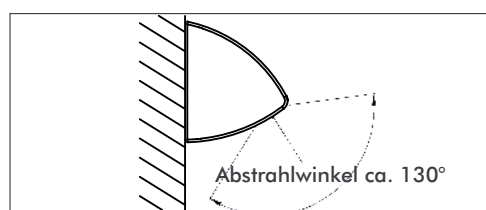
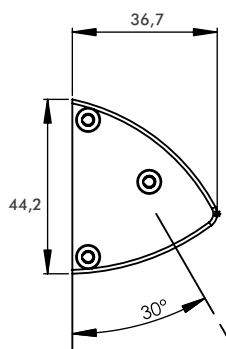

LED Umfeldleuchte

LED Scenelite

Typ: PRO-WALL
 mit Bewegungsmelder/*with Motion Sensor*



Bewegungsmelder/*motion sensor*

Artikel-Nr. Reference-No.	VE QTY	LED Umfeldleuchte für Außen- und Innenbereich PRO-WALL - 18 - 108 Power-LED´s - 280 - 1650 Lumen - Aluminiumgehäuse - Kabel 0,3m - Aufbauversion - IP6K9K - 130° Abstrahlwinkel	LED Scenelite for Outdoor- and Inner area PRO-WALL - 18 - 108 power LED´s - 280 - 1650 Lumen - Aluminium housing - Cable 0,3m - Pendant version - IP6K9K - 130° light output angle
40 060 083	1	24V 280lm	Länge/Length: 268mm Breite/Width: 36,7mm Höhe/Height: 44,2mm
40 060 283	1	12V 280lm	Länge/Length: 268mm Breite/Width: 36,7mm Höhe/Height: 44,2mm
40 060 093	1	24V 740lm	Länge/Length: 573mm Breite/Width: 36,7mm Höhe/Height: 44,2mm
40 060 293	1	12V 740lm	Länge/Length: 573mm Breite/Width: 36,7mm Höhe/Height: 44,2mm
40 060 323	1	24V 1200lm	Länge/Length: 878mm Breite/Width: 36,7mm Höhe/Height: 44,2mm
40 060 423	1	12V 1200lm	Länge/Length: 878mm Breite/Width: 36,7mm Höhe/Height: 44,2mm
40 060 333	1	24V 1650lm	Länge/Length: 1183mm Breite/Width: 36,7mm Höhe/Height: 44,2mm
40 060 433	1	12V 1650lm	Länge/Length: 1183mm Breite/Width: 36,7mm Höhe/Height: 44,2mm

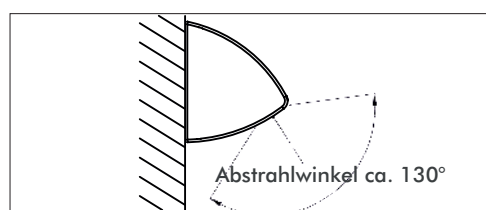
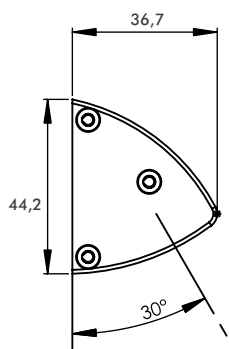

Artikel-Nr. <i>Reference-No.</i>	Notizen <i>Notes</i>

LED Arbeitsscheinwerfer	LED Work Lamps	6.0	- 6.16
LED Punktscheinwerfer	LED Warning Lamps	6.17	
LED Rückfahrcheinwerfer	LED Reversing Lamps	6.18	
LED Zusatz-/Nebelscheinwerfer/ LED Tagfahrleuchten	LED Spot-/Fog Lamps/ LED Daytime Running Lights	6.19	
H3-Arbeitsscheinwerfer	H3-Work Lamps	6.20	
Nebel-/Fernscheinwerfer Hauptscheinwerfer	Fog-/Spot Lamps Driving Lamps		



umverwüstLICHT

LED Arbeitsscheinwerfer

LED Work Lamp

Typ: **PRO-WORK II 12-36V Twin Beam**



Artikel-Nr. Reference-No.	VE QTY	Beschreibung Description	LED Arbeitsscheinwerfer LED Work Lamps	LED Technik LED Technology
40 473 503	1	<p>LED Arbeitsscheinwerfer PRO-WORK II, für breite, großflächige und weitreichende Ausleuchtung, 8 Hochleistungs-LEDs, kompakte Bauform, Kabel 0,5m, 12V-36V, ADR und ECE R10 geprüft Lichtleistung: 3500 Lumen</p> <p><i>LED Work Lamp PRO-WORK II for extreme wide and far-reaching illumination, 8 high intensity LEDs, compact housing, cable 0,5m, 12V-36V, ADR and ECE R10 approved light performance: 3500 Lumen</i></p>	<p>3500lm</p> 	 <p>Lichtverteilungsschema/Light Beam</p>
40 473 003	1	<p>LED Arbeitsscheinwerfer PRO-WORK II, für breite, großflächige und weitreichende Ausleuchtung, 6 Hochleistungs-LEDs, kompakte Bauform, Kabel 0,5m, 12V-36V, ADR und ECE R10 geprüft Lichtleistung: 2500 Lumen</p> <p><i>LED Work Lamp PRO-WORK II for extreme wide and far-reaching illumination, 6 high intensity LEDs, housing, cable 0,5m, 12V-36V, ADR and ECE R10 approved light performance: 2500 Lumen</i></p>	<p>2500lm</p> 	 <p>Lichtverteilungsschema/Light Beam</p>

LED Arbeitsscheinwerfer

LED Work Lamp

Typ: **PRO-WORK II 12-36V Standard Beam**



Artikel-Nr. Reference-No.	VE QTY	Beschreibung Description	LED Arbeitsscheinwerfer LED Work Lamps	LED Technik LED Technology
40 472 503	1	<p>LED Arbeitsscheinwerfer PRO-WORK II, für großflächige, weitreichende Ausleuchtung, 8 Hochleistungs-LEDs, kompakte Bauform, Kabel 0,5m, 12V-36V, ADR und ECE R10 geprüft Lichtleistung: 3500 Lumen</p> <p><i>LED Work Lamp PRO-WORK II for extreme wide illumination, 8 high intensity LEDs, compact housing, cable 0,5m, 12V-36V, ADR and ECE R10 approved light performance: 3500 Lumen</i></p>	<p>3500lm</p>	<p>Lichtverteilungsschema/Light Beam</p>
40 472 003	1	<p>LED Arbeitsscheinwerfer PRO-WORK II, für großflächige, weitreichende Ausleuchtung, 6 Hochleistungs-LEDs, kompakte Bauform, Kabel 0,5m, 12V-36V, ADR und ECE R10 geprüft Lichtleistung: 2500 Lumen</p> <p><i>LED Work Lamp PRO-WORK II for extreme wide illumination, 6 high intensity LEDs, housing, cable 0,5m, 12V-36V, ADR and ECE R10 approved light performance: 2500 Lumen</i></p>	<p>2500lm</p>	<p>Lichtverteilungsschema/Light Beam</p>

LED Arbeitsscheinwerfer

LED Work Lamp

Typ: PRO-WORK II H&S 12-36V Standard Beam

Artikel-Nr. Reference-No.	VE QTY	Beschreibung Description	LED Arbeitsscheinwerfer LED Work Lamps	LED Technik LED Technology
40 472 303	1	<p>LED Arbeitsscheinwerfer PRO-WORK II H&S, für großflächige, weitreichende Ausleuchtung, 8 Hochleistungs-LEDs, Handgriff & Schalter, U-Bügelbefestigung, kompakte Bauform, Kabel 0,5m, 12V-36V, ADR und ECE R10 geprüft Lichtleistung: 3500 Lumen</p> <p><i>LED Work Lamp PRO-WORK II H&S for extreme wide illumination, 8 high intensity LEDs, Handle & Switch, U-bracket, compact housing, cable 0,5m, 12V-36V, ADR and ECE R10 approved light performance: 3500 Lumen</i></p>	<p>3500lm</p>  <p>U-Bügelhalter</p>	  <p>Lichtverteilungsschema/Light Beam</p>
40 472 403	1	<p>LED Arbeitsscheinwerfer PRO-WORK II H&S, für großflächige, weitreichende Ausleuchtung, 8 Hochleistungs-LEDs, Handgriff & Schalter, Spiralkabel 2-polig DEUTSCH DT Stecker ausziehbar bis 3m, Vakuum-/Magnetbefestigung, kompakte Bauform, 12V-36V, ADR und ECE R10 geprüft Lichtleistung: 3500 Lumen</p> <p><i>LED Work Lamp PRO-WORK II H&S for extreme wide illumination, 8 high intensity LEDs, Handle & Switch, spiral cable with 2-pole DEUTSCH DT connector extends up to 3m, vacuum-/magnetic, compact housing, 12V-36V, ADR and ECE R10 approved light performance: 3500 Lumen</i></p>	<p>3500lm</p>  <p>Vakuum-/Magnet</p>	  <p>Lichtverteilungsschema/Light Beam</p>

LED Arbeitsscheinwerfer

LED Work Lamp

Typ: PRO-SUPER-WORK, PRO-WORK 12V/24V

Artikel-Nr. Reference-No.	VE QTY	Beschreibung Description	LED Arbeitsscheinwerfer LED Work Lamps	LED Technik LED Technology
40 460 603	1	<p>LED Arbeitsscheinwerfer PRO-SUPER-WORK, in FF-Technik für großflächige, weitreichende Ausleuchtung, 6 Hochleistungs-Weitwinkel-LEDs, kompakte Bauform, Kabel 1,75m, 12V/24V-11W, ADR/ IP67 geprüft Lichtleistung: 1000 Lumen</p> <p><i>LED Work Lamp PRO-SUPER-WORK in FF-Technology for extreme wide illumination, 6 high intensity wide angle LEDs, compact housing, cable 1,75m, 12V/ 24V-11W, ADR/ IP67 approved light performance: 1000 Lumen</i></p>	<p>1000lm</p> 	  <p>Lichtverteilungsschema/Light Beam</p>
40 460 003	1	<p>LED Arbeitsscheinwerfer PRO-WORK, in FF-Technik für intensive Nahfeldausleuchtung, 6 Hochleistungs-Weitwinkel-LEDs, kompakte Bauform, Kabel 1,75m, 12V/24V-7,9W, ADR/ IP67 geprüft Lichtleistung: 500 Lumen</p> <p><i>LED Work Lamp PRO-WORK in FF-Technology for short distance illumination, 6 high intensity wide angle LEDs, compact housing, cable 1,75m, 12V/ 24V-7,9W, ADR/ IP67 approved light performance: 500 Lumen</i></p>	<p>500lm</p> 	  <p>Lichtverteilungsschema/Light Beam</p>

LED Arbeitsscheinwerfer

LED Work Lamp

Typ: PRO-ROCK II 12-80V Standard Beam

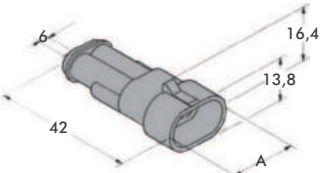
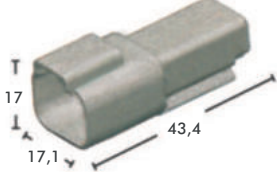
Artikel-Nr. Reference-No.	VE QTY	Beschreibung Description	LED Arbeitsscheinwerfer LED Work Lamps	LED Technik LED Technology
40 469 003	1	<p>LED Arbeitsscheinwerfer PRO-ROCK II, für großflächige, weitreichende Ausleuchtung, 10 Hochleistungs-LED's, robustes Aluminium Druckgussgehäuse, Kabel 0,5m, 12V-80V, 25W, IP6K9K geprüft, Lichtleistung: 2000 Lumen</p> <p><i>LED Work Lamp PRO-ROCK II for far-reaching illumination, 10 high power LEDs, aluminium die cast housing, cable 0,5m, 12V-80V, 25W, IP6K9K approved, light performance: 2000 lumen</i></p>	<p>2000lm</p> 	
40 469 073	1	<p>LED Arbeitsscheinwerfer PRO-ROCK II, für großflächige, weitreichende Ausleuchtung, 10 Hochleistungs-LED's, robustes Aluminium Druckgussgehäuse, 12V-80V, 25W, IP6K9K geprüft, Kabel 0,2m mit AMP SUPER SEAL Stecker Lichtleistung: 2000 Lumen</p> <p><i>LED Work Lamp PRO-ROCK II for far-reaching illumination, 10 high power LEDs, aluminium die cast housing, 12V-80V, 25W, IP6K9K approved, cable 0,2m with AMP SUPER SEAL connector light performance: 2000 lumen</i></p>	<p>2000lm</p>  <p>AMP SUPER SEAL</p>	  <p>Lichtverteilungsschema/Light Beam</p>
40 469 083	1	<p>LED Arbeitsscheinwerfer PRO-ROCK II, für großflächige, weitreichende Ausleuchtung, 10 Hochleistungs-LED's, robustes Aluminium Druckgussgehäuse, 12V-80V, 25W, IP6K9K geprüft, Kabel 0,2m mit DEUTSCH DT Stecker Lichtleistung: 2000 Lumen</p> <p><i>LED Work Lamp PRO-ROCK II for far-reaching illumination, 10 high power LEDs, aluminium die cast housing, 12V-80V, 25W, IP6K9K approved, cable 0,2m with DEUTSCH DT connector light performance: 2000 lumen</i></p>	<p>2000lm</p>  <p>DEUTSCH DT</p>	

LED Arbeitsscheinwerfer

LED Work Lamp

Typ: PRO-ROCK II 12-80V Wider Beam

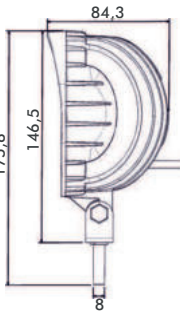
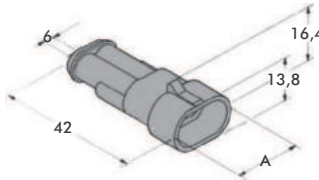
Artikel-Nr. Reference-No.	VE QTY	Beschreibung Description	LED Arbeitsscheinwerfer LED Work Lamps	LED Technik LED Technology
40 469 013	1	<p>LED Arbeitsscheinwerfer PRO-ROCK II, für breite Nahfeldausleuchtung, 10 Hochleistungs-LED's, robustes Aluminium Druckgussgehäuse, Kabel 0,5m, 12V-80V, 25W, IP6K9K geprüft, Lichtleistung: 2000 Lumen</p> <p><i>LED Work Lamp PRO-ROCK II for extreme wide illumination, 10 high power LEDs, aluminium die cast housing, cable 0,5m, 12V-80V, 25W, IP6K9K approved, light performance: 2000 lumen</i></p>	<p>2000lm</p> 	 
40 469 773	1	<p>LED Arbeitsscheinwerfer PRO-ROCK II, für breite Nahfeldausleuchtung, 10 Hochleistungs-LED's, robustes Aluminium Druckgussgehäuse, 12V-80V, 25W, IP6K9K geprüft, Kabel 0,2m mit AMP SUPER SEAL Stecker Lichtleistung: 2000 Lumen</p> <p><i>LED Work Lamp PRO-ROCK II for extreme wide illumination, 10 high power LEDs, aluminium die cast housing, 12V-80V, 25W, IP6K9K approved, cable 0,2m with AMP SUPER SEAL connector light performance: 2000 lumen</i></p>	<p>2000lm</p>  <p>AMP SUPER SEAL</p>	  <p>Lichtverteilungsschema/Light Beam</p>
40 469 783	1	<p>LED Arbeitsscheinwerfer PRO-ROCK II, für breite Nahfeldausleuchtung, 10 Hochleistungs-LED's, robustes Aluminium Druckgussgehäuse, 12V-80V, 25W, IP6K9K geprüft, Kabel 0,2m mit DEUTSCH DT Stecker Lichtleistung: 2000 Lumen</p> <p><i>LED Work Lamp PRO-ROCK II for extreme wide illumination, 10 high power LEDs, aluminium die cast housing, 12V-80V, 25W, IP6K9K approved, cable 0,2m with DEUTSCH DT connector light performance: 2000 lumen</i></p>	<p>2000lm</p>  <p>DEUTSCH DT</p>	

LED Arbeitsscheinwerfer

LED Work Lamp

Typ: PRO-ROCK II 12-80V Spot Beam
PRO-INDU-ROCK 10-110V Standard Beam







Artikel-Nr. Reference-No.	VE QTY	Beschreibung Description	LED Arbeitsscheinwerfer LED Work Lamps	LED Technik LED Technology
40 469 023	1	<p>LED Arbeitsscheinwerfer PRO-ROCK II, für punktuelle, weitreichende Ausleuchtung, 10 Hochleistungs-LED's, robustes Aluminium Druckgussgehäuse, Kabel 0,5m, 12V-80V, 25W, IP6K9K geprüft, Lichtleistung: 2000 Lumen</p> <p><i>LED Work Lamp PRO-ROCK II for long distance illumination, 10 high power LEDs, aluminium die cast housing, cable 0,5m, 12V-80V, 25W, IP6K9K approved, light performance: 2000 lumen</i></p>	<p>2000lm</p>	<p>Lichtverteilungsschema/Light Beam</p>
40 469 903	1	<p>LED Arbeitsscheinwerfer PRO-INDU-ROCK, für den industriellen Einsatz, homogene Ausleuchtung, 6 POWER-LED's, robustes Aluminium Druckgussgehäuse, Kabel 0,45m, 10V - 110V, 30W, IP67, Lichtleistung: 2100 Lumen</p> <p><i>LED Work Lamp PRO-INDU-ROCK for industrial use, homogeneous illumination, 6 high power LEDs, aluminium die cast housing, cable 0,45m, 10V - 110V, 30W, IP67, light performance: 2100 lumen</i></p>	<p>2100lm</p>	

LED Arbeitsscheinwerfer

LED Work Lamp

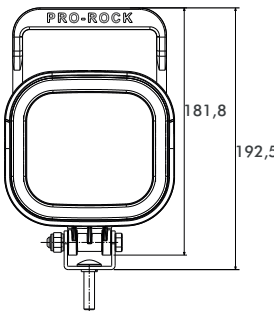
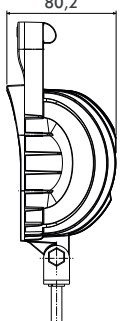
Typ: PRO-ROCK II H&S 12-36V Standard Beam

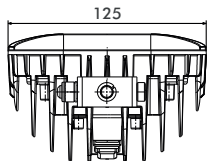
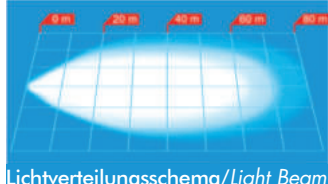
Artikel-Nr. Reference-No.	VE QTY	Beschreibung Description	LED Arbeitsscheinwerfer LED Work Lamps	LED Technik LED Technology
40 469 303	1	<p>LED Arbeitsscheinwerfer PRO-ROCK II H&S, für großflächige, weitreichende Ausleuchtung, mit Griff & Schalter, 10 Hochleistungs-LED's, robustes Aluminium Druckgussgehäuse, Kabel 0,5m, 12-36V, 25W, IP6K9K geprüft, Befestigung: U-Bügelhalter, Lichtleistung: 2000 Lumen</p> <p><i>LED Work Lamp PRO-ROCK II H&S for far-reaching illumination, with handle & switch, 10 high power LEDs, aluminium die cast housing, cable 0,5m, 12-36V, 25W, IP6K9K approved, fixation: U-bracket, light performance: 2000 lumen</i></p>	<p>2000lm</p>   <p>U-Bügelhalter</p>	 
40 469 403	1	<p>LED Arbeitsscheinwerfer PRO-ROCK II H&S, für großflächige, weitreichende Ausleuchtung, mit Griff & Schalter, 10 Hochleistungs-LED's, robustes Aluminium Druckgussgehäuse, Spiralkabel 2-polig DEUTSCH DT Stecker ausziehbar bis 3m, 12-36V, 25W, IP6K9K geprüft, Befestigung: Vakuum/Magnet, Lichtleistung: 2000 Lumen</p> <p><i>LED Work Lamp PRO-ROCK II H&S for far-reaching illumination, with handle & switch, 10 high power LEDs, aluminium die cast housing, spiral cable with 2-pole DEUTSCH DT connector extends up to 3m, 12-36V, 25W, IP6K9K approved, fixation: Vacuum/Magnetic, light performance: 2000 lumen</i></p>	<p>2000lm</p>   <p>Vakuum-/Magnet</p>	  <p>Lichtverteilungsschema/Light Beam</p>

LED Arbeitsscheinwerfer

LED Work Lamp

Typ: **PRO-POWER-ROCK 12-36V Standard Beam**



Artikel-Nr. Reference-No.	VE QTY	Beschreibung Description	LED Arbeitsscheinwerfer LED Work Lamps	LED Technik LED Technology
40 467 503	1	<p>LED Arbeitsscheinwerfer PRO-POWER-ROCK, für großflächige, weitreichende Ausleuchtung, 6 Power-LED`s, robustes Aluminium Druckgussgehäuse, Kabel 2,0m, 12V-62W, 24V-67W, IP6K9K geprüft, Lichtleistung: 4500 Lumen</p> <p><i>LED Work Lamp PRO-POWER-ROCK for far-reaching illumination, 6 high power LEDs, aluminium die cast housing, cable 2,0m, 12V-62W, 24V-67W, IP6K9K approved, light performance: 4500 lumen</i></p>	<p>4500lm</p> 	 
40 467 773	1	<p>LED Arbeitsscheinwerfer PRO-POWER-ROCK, für großflächige, weitreichende Ausleuchtung, 6 Power-LED`s, robustes Aluminium Druckgussgehäuse, 12V-62W, 24V-67W, IP6K9K geprüft, Kabel 0,2m mit AMP SUPER SEAL Stecker Lichtleistung: 4500 Lumen</p> <p><i>LED Work Lamp PRO-POWER-ROCK for far-reaching illumination, 6 high power LEDs, aluminium die cast housing, 12V-62W, 24V-67W, IP6K9K approved, cable 0,2m with AMP SUPER SEAL connector light performance: 4500 lumen</i></p>	<p>4500lm</p>  <p>AMP SUPER SEAL</p>	 
40 467 783	1	<p>LED Arbeitsscheinwerfer PRO-POWER-ROCK, für großflächige, weitreichende Ausleuchtung, 6 Power-LED`s, robustes Aluminium Druckgussgehäuse, 12V-62W, 24V-67W, IP6K9K geprüft, Kabel 0,2m mit DEUTSCH DT Stecker Lichtleistung: 4500 Lumen</p> <p><i>LED Work Lamp PRO-POWER-ROCK for far-reaching illumination, 6 high power LEDs, aluminium die cast housing, 12V-62W, 24V-67W, IP6K9K approved, cable 0,2m with DEUTSCH DT connector light performance: 4500 lumen</i></p>	<p>4500lm</p>  <p>DEUTSCH DT</p>	

LED Arbeitsscheinwerfer

LED Work Lamp

Typ: PRO-ROCK-EXTREME 9-32V Standard Beam
PRO-POWER-ROCK 12-36V Spot Beam
PRO-SUPER-ROCK 12-36V Standard Beam



Artikel-Nr. Reference-No.	VE QTY	Beschreibung Description	LED Arbeitsscheinwerfer LED Work Lamps	LED Technik LED Technology
NEW 40 426 003	1	<p>LED Arbeitsscheinwerfer PRO-ROCK-EXTREME, für extrem weitreichende Ausleuchtung, 20 Hochleistungs-LED's, sehr stabiles Druckgussgehäuse Aluminium, Lichtscheibe aus bruchfestem Polycarbonat, Kabel 0,45m, 9-32V, 100 Watt, Lichtleistung: 7000 Lumen</p> <p><i>LED Work Lamp PRO-ROCK-EXTREME for extreme wide illumination, 20 high intensity LEDs, aluminium die cast housing, lens made of unbreakable polycarbonate, cable 0,45m, 9-32V, 100 Watt, light performance: 7000 lumen</i></p>	<p>7000lm</p>	
40 467 523	1	<p>LED Arbeitsscheinwerfer PRO-POWER-ROCK, für extrem weite, punktuelle Ausleuchtung, 6 Power-LED's, robustes Aluminium Druckgussgehäuse, Kabel 2,0m, 12V-62W, 24V-67W, IP6K9K geprüft, Lichtleistung: 4500 Lumen</p> <p><i>LED Work Lamp PRO-POWER-ROCK for long distance illumination, 6 high power LEDs, aluminium die cast housing, cable 2,0m, 12V-62W, 24V-67W, IP6K9K approved, light performance: 4500 lumen</i></p>	<p>4500lm</p>	<p>Lichtverteilungsschema/Light Beam</p>
40 467 003	1	<p>LED Arbeitsscheinwerfer PRO-SUPER-ROCK, für großflächige, weitreichende Ausleuchtung, 6 Power-LED's, robustes Aluminium Druckgussgehäuse, Kabel 2,0m, 12V-53W, 24V-60W, IP6K9K geprüft, Lichtleistung: 3000 Lumen</p> <p><i>LED Work Lamp PRO-SUPER-ROCK for far-reaching illumination, 6 high power LEDs, aluminium die cast housing, cable 2,0m, 12V-53W, 24V-60W, IP6K9K approved, light performance: 3000 lumen</i></p>	<p>3000lm</p>	<p>Lichtverteilungsschema/Light Beam</p>

LED Arbeitsscheinwerfer

LED Work Lamp

Typ: PRO-MIDI-ROCK 12-36V Standard Beam

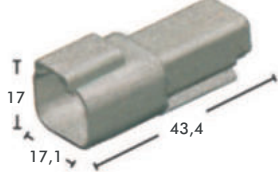

Artikel-Nr. Reference-No.	VE QTY	Beschreibung Description	LED Arbeitsscheinwerfer LED Work Lamps	LED Technik LED Technology
40 470 003	1	<p>LED Arbeitsscheinwerfer PRO-MIDI-ROCK, für Nahfeldausleuchtung, 2 Power LED's, robustes Aluminium Druckgussgehäuse, Kabel 0,5m, 12V-36V, 20W, IP6K9K geprüft, Lichtleistung: ca. 1800 Lumen</p> <p><i>LED Work Lamp PRO-MIDI-ROCK for short distance illumination, 2 Power LED's, aluminium die cast housing, cable 0,5m, 12V-36V, 20W, IP6K9K approved, light performance: 1800 lumen</i></p>	<p>1800lm</p> 	 
40 470 073	1	<p>LED Arbeitsscheinwerfer PRO-MIDI-ROCK, für Nahfeldausleuchtung, 2 Power LED's, robustes Aluminium Druckgussgehäuse, 12V-36V, 20W, IP6K9K geprüft, Kabel 0,2m mit AMP SUPER SEAL Stecker Lichtleistung: ca. 1800 Lumen</p> <p><i>LED Work Lamp PRO-MIDI-ROCK for short distance illumination, 2 Power LED's, aluminium die cast housing, 12V-36V, 20W, IP6K9K approved, cable 0,2m with AMP SUPER SEAL connector light performance: 1800 lumen</i></p>	<p>1800lm</p>  <p>AMP SUPER SEAL</p>	  <p>Lichtverteilungsschema/Light Beam</p>
40 470 083	1	<p>LED Arbeitsscheinwerfer PRO-MIDI-ROCK, für Nahfeldausleuchtung, 2 Power LED's, robustes Aluminium Druckgussgehäuse, 12V-36V, 20W, IP6K9K geprüft, Kabel 0,2m mit DEUTSCH DT Stecker Lichtleistung: ca. 1800 Lumen</p> <p><i>LED Work Lamp PRO-MIDI-ROCK for short distance illumination, 2 Power LED's, aluminium die cast housing, 12V-36V, 20W, IP6K9K approved, cable 0,2m with DEUTSCH DT connector light performance: 1800 lumen</i></p>	<p>1800lm</p>  <p>DEUTSCH DT</p>	

LED Arbeitsscheinwerfer

LED Work Lamp

Typ: PRO-MIDI-ROCK 12-36V Spot Beam

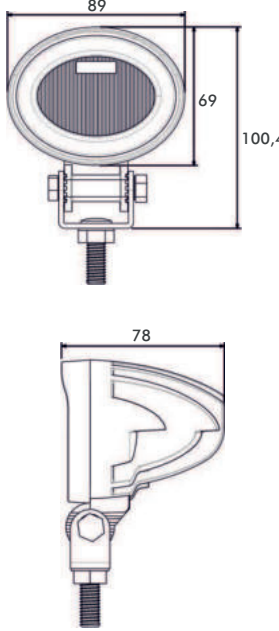
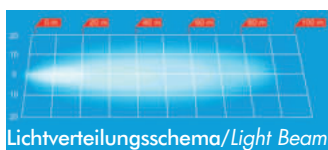

Artikel-Nr. <i>Reference-No.</i>	VE <i>QTY</i>	Beschreibung <i>Description</i>	LED Arbeitsscheinwerfer <i>LED Work Lamps</i>	LED Technik <i>LED Technology</i>
40 470 023	1	<p>LED Arbeitsscheinwerfer PRO-MIDI-ROCK, für punktuelle, weitreichende Ausleuchtung, 2 Power LED's, robustes Aluminium Druckgussgehäuse, Kabel 0,5m, 12V-36V, 20W, IP6K9K geprüft, Lichtleistung: ca. 1800 Lumen</p> <p><i>LED Work Lamp PRO-MIDI-ROCK for long distance illumination, 2 Power LED's, aluminium die cast housing, cable 0,5m, 12V-36V, 20W, IP6K9K approved, light performance: 1800 lumen</i></p>	<p>1800lm</p> 	
				 <p>Lichtverteilungsschema/Light Beam</p>

LED Arbeitsscheinwerfer

LED Work Lamp

Typ: **PRO-MINI-ROCK 1000 12-36V**



Artikel-Nr. Reference-No.	VE QTY	Beschreibung Description	LED Arbeitsscheinwerfer LED Work Lamps	LED Technik LED Technology
40 468 003	1	<p>LED Arbeitsscheinwerfer PRO-MINI-ROCK, für Nahfeldausleuchtung, 1 Power LED, robustes Aluminium Druckgussgehäuse, Kabel 0,5m, 12V-36V, 11W, IP6K9K geprüft, Lichtleistung: ca. 1000 Lumen</p> <p><i>LED Work Lamp PRO-MINI-ROCK for short distance illumination, 1 high power LED, aluminium die cast housing, cable 0,5m, 12V-36V, 11W, IP6K9K approved, light performance: 1000 lumen</i></p>	<p>1000lm</p> 	
40 468 073	1	<p>LED Arbeitsscheinwerfer PRO-MINI-ROCK, für Nahfeldausleuchtung, 1 Power LED, robustes Aluminium Druckgussgehäuse, 12V-36V, 11W, IP6K9K geprüft, Kabel 0,2m mit AMP SUPER SEAL Stecker Lichtleistung: ca. 1000 Lumen</p> <p><i>LED Work Lamp PRO-MINI-ROCK for short distance illumination, 1 high power LED, aluminium die cast housing, 12V-36V, 11W, IP6K9K approved, cable 0,2m with AMP SUPER SEAL connector light performance: 1000 lumen</i></p>	<p>1000lm</p>  <p>AMP SUPER SEAL</p>	  <p>Lichtverteilungsschema/Light Beam</p>
40 468 083	1	<p>LED Arbeitsscheinwerfer PRO-MINI-ROCK, für Nahfeldausleuchtung, 1 Power LED, robustes Aluminium Druckgussgehäuse, 12V-36V, 11W, IP6K9K geprüft, Kabel 0,2m mit DEUTSCH DT Stecker Lichtleistung: ca. 1000 Lumen</p> <p><i>LED Work Lamp PRO-MINI-ROCK for short distance illumination, 1 high power LED, aluminium die cast housing, 12V-36V, 11W, IP6K9K approved, cable 0,2m with DEUTSCH DT connector light performance: 1000 lumen</i></p>	<p>1000lm</p>  <p>DEUTSCH DT</p>	

LED Arbeitsscheinwerfer

LED Work Lamp

Typ: **PRO-MINI-ROCK 500 12-36V**



Artikel-Nr. Reference-No.	VE QTY	Beschreibung Description	LED Arbeitsscheinwerfer LED Work Lamps	LED Technik LED Technology
40 468 013	1	<p>LED Arbeitsscheinwerfer PRO-MINI-ROCK, für Nahfeldausleuchtung, 2 LED`s, robustes Aluminium Druckgussgehäuse, Kabel 0,5m, 12V-36V, 6,5W, IP6K9K geprüft, Lichtleistung: ca. 500 Lumen</p> <p><i>LED Work Lamp PRO-MINI-ROCK for short distance illumination, 2 LED`s, aluminium die cast housing, cable 0,5m, 12V-36V, 6,5W, IP6K9K approved, light performance: 500 lumen</i></p>	<p>500lm</p> 	  <p>Lichtverteilungsschema/Light Beam</p>
40 468 015	1	<p>LED Arbeitsscheinwerfer PRO-MINI-ROCK blue blaue Ausleuchtung, 2 LED`s, robustes Aluminium Druckgussgehäuse, Kabel 0,5m, 12V-36V, 6,5W, IP6K9K geprüft</p> <p><i>LED Work Lamp PRO-MINI-ROCK blue blue illumination, 2 LED`s, aluminium die cast housing, cable 0,5m, 12V-36V, 6,5W, IP6K9K approved</i></p>		

LED Arbeitsscheinwerfer

LED Work Lamp

Typ: PRO-SUPER-FIELD 9-32V
PRO-INDU-FIELD 10-110V
PRO-ECO-FIELD 10-30V

Standard Beam



Artikel-Nr. Reference-No.	VE QTY	Beschreibung Description	LED Arbeitsscheinwerfer LED Work Lamps	LED Technik LED Technology
40 429 003	1	<p>LED Arbeitsscheinwerfer PRO-SUPER-FIELD, für großflächige, weitreichende Ausleuchtung, 6 Hochleistungs-LED's, robustes Aluminium Druckgussgehäuse, Lichtscheibe aus bruchfestem Polycarbonat, Kabel 0,45m, 9-32V, 18W, R10 Lichtleistung: 1500 Lumen</p> <p><i>LED Work Lamp PRO-SUPER-FIELD, for far-reaching illumination, 6 high power LEDs, aluminium die cast housing, lens made of unbreakable polycarbonate, cable 0,45m, 9-32V, 18W, R10 light performance: 1500 lumen</i></p>	<p>1500lm</p>	
40 429 303	1	<p>LED Arbeitsscheinwerfer PRO-SUPER-FIELD, dito., mit Schalter</p> <p><i>LED Work Lamp PRO-SUPER-FIELD, with switch</i></p>		<p>Flood Beam</p>
40 429 903	1	<p>LED Arbeitsscheinwerfer PRO-INDU-FIELD, für den industriellen Einsatz, homogene Ausleuchtung, 6 Hochleistungs-LED's, robustes Aluminium Druckgussgehäuse, Lichtscheibe aus bruchfestem Polycarbonat, Kabel 0,45m, 10-110V, 18W, R10 Lichtleistung: 1500 Lumen</p> <p><i>LED Work Lamp PRO-INDU-FIELD, for industrial use, homogeneous illumination, 6 high power LEDs, aluminium die cast housing, lens made of unbreakable polycarbonate, cable 0,45m, 10-110V, 18W, R10 light performance: 1500 lumen</i></p>	<p>1500lm</p>	
40 425 003	1	<p>LED Arbeitsscheinwerfer PRO-ECO-FIELD, für Nahfeldausleuchtung, 4 Hochleistungs-LED's, Aluminium Druckgussgehäuse, Lichtscheibe aus Polycarbonat, Kabel 0,45m, 10-30V, 12W, R10 Lichtleistung: 1100 Lumen</p> <p><i>LED Work Lamp PRO-INDU-FIELD, for short distance illumination, 4 high power LEDs, aluminium die cast housing, lens made of PC, cable 0,45m, 10-30V, 12W, R10 light performance: 1100 lumen</i></p>	<p>1100lm</p>	

LED Arbeitsscheinwerfer

LED Work Lamp

Typ: PRO-SUPER-FIELD H&B
PRO-STEP

Artikel-Nr. Reference-No.	VE QTY	Beschreibung Description	LED Arbeitsscheinwerfer LED Work Lamps	LED Technik LED Technology
40 429 503	1	<p>Aufladbarer LED Arbeitsscheinwerfer PRO-SUPER-FIELD H&B, für breite Nahfeldausleuchtung, kompakte Bauform, Aluminium Druckgussgehäuse, Lichtscheibe aus bruchfestem Polycarbonat, Magnetbefestigung, 9W, ECE R10 geprüft, Ladezeit ca. 4 Stunden, Einsatzzeit ca. 4 Stunden, inkl. 220V Ladegerät und 12V Stecker für Zigarettenanzünder</p> <p><i>Rechargeable LED Work Lamp PRO-SUPER-FIELD H&B, compact profile, aluminium die cast housing, lens are constructed of unbreakable polycarbonate, magnetic fixation, 9W, ECE R10 approved, charging time ca. 4 hours, discharging time ca. 4 hours, incl. 220V power supply and 12V cigarette plug charger</i></p>	<p>650lm</p>  <p>Ein/Aus-Schalter Funktionsschalter ON/OFF Switch Function selector</p> <p>1 - 100% Intensity (white) 2 - 50% Intensity (white) 3 - SOS (white) 4 - Quad-Flash (amber)</p>	
40 475 003	1	<p>LED Leuchte PRO-STEP, 3 Power-LED´s, Lichtaustritt weiß, Aluminiumdruckguss Gehäuse, wasserdicht vergossen, 12/24V, IP67 Anschluss: Kabel 0,5m</p> <p><i>LED Lamp PRO-STEP, 3 power LEDs, white illumination, aluminium die cast housing, lamp complete potted, 12/24V, IP67 Connection: cable 0,5m</i></p>	<p>650lm</p> 	

LED Arbeitsscheinwerfer Bar

LED Work Light Bar

Typ: **PRO-STREAM**



Artikel-Nr. Reference-No.	VE QTY	LED Arbeitsscheinwerfer PRO-STREAM - 18 - 36 Hochleistungs-LED´s - 12V/24V - Besonders flache Bauform - Lichthauben aus bruchfestem PC - weitreichende, punktuelle Ausleuchtung - Befestigung: 2 Befestigungswinkel - Kabel 3,0m, ECE R10 geprüft	LED Work Lamp PRO-STREAM - 18 - 36 high power LED´s - 12V/24V - Very low profile - Polycarbonate moulded lens - long distance illumination - Fixation: 2 brackets - Cable 3,0m, ECE R10 approved
40 433 503	1	12V 24V Länge/Length: 516mm	Verbrauch/Consumption: 54 Watt 3800lm
40 433 703	1	12V 24V Länge/Length: 759mm	Verbrauch/Consumption: 81 Watt 5700lm
40 433 103	1	12V 24V Länge/Length: 1002mm	Verbrauch/Consumption: 108 Watt 7600lm

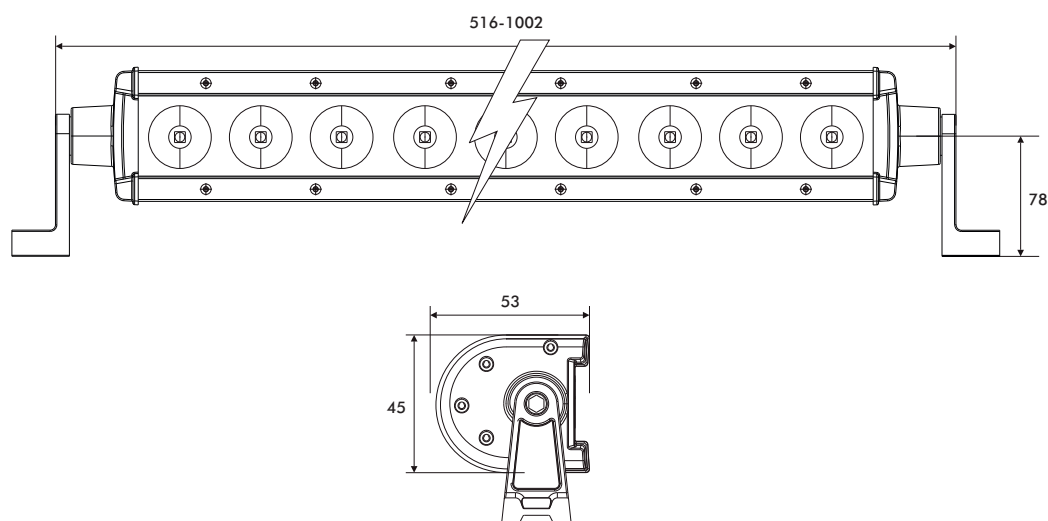

Weitere Längen auf Anfrage

Further Length on request

LED Punktscheinwerfer

LED Warning Lamp







Artikel-Nr. Reference-No.	VE QTY	Beschreibung Description	LED Punktscheinwerfer LED Warning Lamps	LED Technik LED Technology
40 414 003	1	<p>LED Punktscheinwerfer PRO-FLT optische Fahrweg-Warnleuchte, Lichtaustritt blau, Kabel 0,45m, 10-94V - 12W</p> <p><i>LED Warning Lamp PRO-FLT spot beam optical driving path warning lamp, light emission blue, cable 0,45m, 10-94V - 12W</i></p>		 
40 417 003	1	<p>LED Punktscheinwerfer optische Fahrweg-Warnleuchte, Lichtaustritt blau, Kabel 0,45m, 9-48V - 6W</p> <p><i>LED Warning Lamp spot beam optical driving path warning lamp, light emission blue, cable 0,45m, 9-48V - 6W</i></p>		 
40 430 002	1	<p>LED Warnscheinwerfer optische Fahrweg-Warnleuchte linienförmige Ausleuchtung, Lichtaustritt rot, Kabel 0,5m, 10-80V - 5W, ECE R10</p> <p><i>LED Warning Line Lamp, optical driving path warning lamp, line shape illumination, light emission red, cable 0,5m, 10-80V - 5W, ECE R10</i></p>		 

LED Rückfahrscheinwerfer

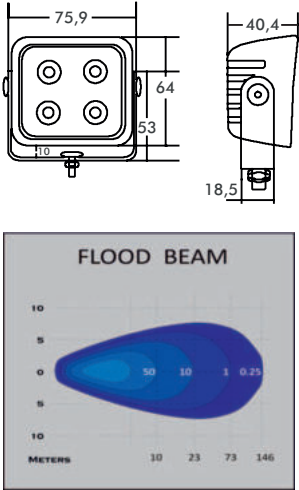
LED Reversing Lamp

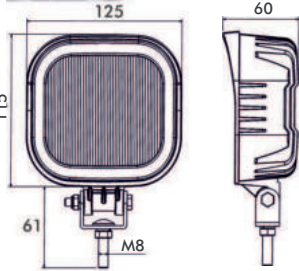
Typ: PRO-FIELD, PRO-REVERSE, PRO-REAR

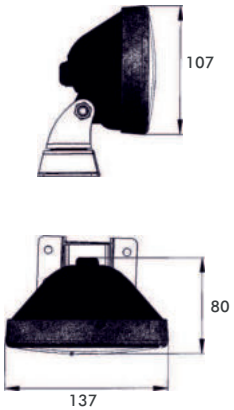





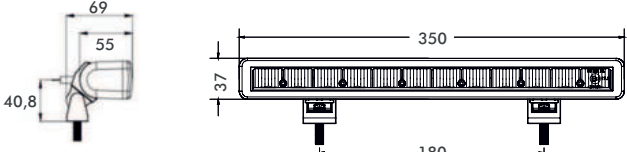

Artikel-Nr. Reference-No.	VE QTY	Beschreibung Description	LED Rückfahrscheinwerfer LED Reversing Lamps	LED Technik LED Technology
NEW 40 424 003	1	<p>LED Rückfahrscheinwerfer PRO-FIELD, geprüft gem. ECE R23, auch als Arbeitsscheinwerfer einsetzbar, ca. 800lm, sehr homogene Ausleuchtung, extrem kompakte Bauform, robustes Aluminium Druckgussgehäuse, Lichtscheibe aus bruchfestem Polycarbonat, 12W, Kabel 0,45m, ADR-geprüft, ECE R10 geprüft, 9-32V</p> <p><i>LED Reversing-Work Lamp PRO-FIELD, according to ECE R23, useable as Work Lamp, 800 lumen, homogeneous illumination, extreme compact profile, aluminium die cast housing, lens are constructed of unbreakable polycarbonate, 12W, cable 0,45m, ADR-appr., ECE R10 appr., 9-32V</i></p>		
40 466 003	1	<p>LED Rückfahrscheinwerfer PRO-REVERSE, geprüft gem. ECE R23, leistungsstarker Scheinwerfer mit Hochleistungs-LEDs, klare Streuscheibe aus bruchfestem PC, kleine kompakte Bauform, Kabel 0,5m, ADR-geprüft, 12V/24V, 8W</p> <p><i>LED Reversing Lamp PRO-REVERSE, according to ECE R23, clear lens made of unbreakable PC, small, solid housing, cable 0,5m, ADR-appr., 12V/24V, 8W</i></p>		
40 460 903	1	<p>LED Rückfahrscheinwerfer PRO-REAR, geprüft gem. ECE R23, hohe Lichtstärke durch brillantes Freiformspiegel-Design 6 Hochleistungs-LEDs, Streuscheibe aus bruchfestem PC, U-Bügelbefestigung, kleine kompakte Bauform, Kabel 1,75m ADR-geprüft, 12V-6,2W, 24V-7,7W</p> <p><i>LED Reversing Lamp PRO-REAR accord. to ECE R23, high light intensity due to brilliant free-form technology, 6 high power LEDs, Lens made of unbreakable PC, cable 1,75m, ADR-appr., 12V-6,2W, 24V-7,7W</i></p>		

LED Zusatz-, LED Nebelscheinwerfer, LED Tagfahrleuchte

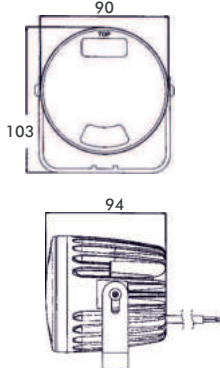
LED Spot-, LED Fog-, LED Daytime Running Lamp

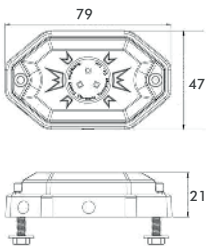

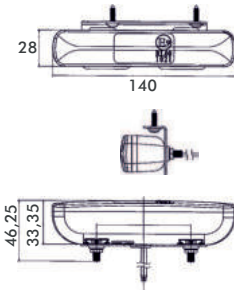
Typ: PRO-DRIVE II, PRO-FOG II, PRO-DAY II, PRO-STEP



Artikel-Nr. Reference-No.	VE QTY	Beschreibung Description	LED Scheinwerfer LED Lamps	LED Technik LED Technology
NEW 40 432 003	1	LED-Zusatzscheinwerfer PRO-DRIVE II , robustes Aluminiumgehäuse, Anschlussleitung 0,5m, Lichtscheibe aus Polycarbonat, ECE R112 & ECE R10 geprüft, 2400 Lumen, 12V/24V - 36W <i>LED Spot Lamp PRO-DRIVE II, solid aluminium housing, cable 0,5m, Lens made of Polycarbonat, ECE R112 & ECE R10 approved, 2400 lm, 12V/24V - 36W</i>	2400lm  	EMC
40 407 003	1	LED-Nebelscheinwerfer PRO-FOG II , robustes Metallgehäuse, Streuscheibe aus Polycarbonat, 1000 Lm, ECE R19 & ECE R10 geprüft, gemäß SAE J583 F3, 12V/24V - 12W <i>LED Fog Lamp PRO-FOG II, solid metal housing, Lens made of Polycarbonat, 1000 lm, ECE R19 & ECE R10 appr., according to SAE J583 F3, 12V/24V - 12W</i>	1000lm  	EMC
NEW 40 475 003	1	LED Leuchte PRO-STEP , 3 Power-LED's, Lichtaustritt weiß, Aluminiumdruckguss Gehäuse, wasserdicht vergossen, 12/24V, IP67 Anschluss: Kabel 0,5m <i>LED Lamp PRO-STEP, 3 power LEDs, white illumination, aluminium die cast housing, lamp complete potted, 12/24V, IP67 Connection: cable 0,5m</i>	650lm  	EMC
40 405 003	1	LED Tagfahrleuchte PRO-DAY II , geprüft gem. ECE R87 8 Hochleistungs-LEDs, kleine, kompakte Bauform, Kabel 0,5m, IP67, 12/24V - 4W <i>LED Daytime Running Light PRO-DAY II ECE R87, high light intensity, 8 high power LEDs, cable 0,5m, IP67, 12/24V - 4W</i>	 	

Arbeits-/Fern-/Hauptscheinwerfer

Work-/Spot-/Driving Lamp

Artikel-Nr. Reference-No.	VE QTY	Beschreibung Description	Scheinwerfer Lamp	
40 448 003	1	<p>H3-Arbeitscheinwerfer mit Glasstreuscheibe für großflächige, intensive Nahfeldausleuchtung, U-Bügelbef., kleine kompakte Bauform, ADR-gepr., IP54, H3 12V/24V</p> <p><i>H3-Work Lamp, with Glass Lens for extreme wide illumination, small, solid housing, ADR-appr., IP54 H3 12V/24V</i></p>	 <p>Anschluss Gehäuse-rückseite Backside Connector</p>  	 <p>Lichtverteilungsschema Light Beam</p>
40 455 003	1	<p>Klarglas H1-Fernscheinwerfer mit LED Standlichtfunktion, Glasstreuscheibe, Gehäuse aus schlagfestem Kunststoff, komplett verkabelt inkl. Glühlampe H1 24V/70W</p> <p><i>H1-Spot Lamp with LED parking light, glass Lens, solid plastic housing, complete cabled and with bulb H1 24V/70W</i></p>	 <p>LED Standlichtfunktion</p>	<p>P14,5s/H1</p> 
40 454 003	1	<p>Klarglas H1-Fernscheinwerfer mit Standlichtfunktion, Glasstreuscheibe, Gehäuse aus schlagfestem Kunststoff, komplett verkabelt und mit Glühlampen H1 24V/70W u. 24V/4W bestückt</p> <p><i>H1-Spot Lamp with parking light, glass Lens, solid plastic housing, complete cabled and with bulbs H1 24V/70W+24V/4W</i></p>		<p>P14,5s/H1 + BA9s/T4W</p> 
40 410 213	1	<p>H3-Fernscheinwerfer, Glasstreuscheibe mit schwarzem Glashalterahmen H3 12V/24V</p> <p><i>H3-Spot Lamp, Glass Lens with black ring, H3 12V/24V</i></p>		<p>PK 22s / H3</p> 
40 410 113	1	<p>Scheinwerfereinsatz für Fernscheinwerfer</p> <p><i>Lens for Spot Lamp</i></p>	<p>Standlichtfunktion Parking Light</p>	

LED Kennleuchten
Rundumkennleuchten
Xenon Blitz-Kennleuchten
Aufsteckrohre
Optische Warnanlagen

LED Beacons
Rotating Beacons
Xenon Beacons
Pole Mount Brackets
Lightbars

7.0 - 7.11
7.12 - 7.13
7.14
7.15
7.16 - 7.20



LED Kennleuchte

LED Beacon

Typ: PRO-MULTI-FLASH II

Artikel-Nr. Reference-No.	VE QTY	Beschreibung Description	LED Kennleuchten LED Beacons	gemäß ECE R65 according to ECE R65
40 599 001	1	<p>LED Kennleuchte PRO-MULTI-FLASH II gemäß ECE R65, R10, ultraflache Bauform, 7 Warnfunktionen, 12/24V - 27W, 15 Leuchten synchronisierbar, Leuchte wasserdicht verschlossen, ADR geprüft, Einsatztemperatur -30°C - +60°C Befestigung: 3 - Punkt</p> <p>LED Beacon PRO-MULTI-FLASH II according to ECE R65, R10, ultra low profile, 7 flash pattern, 12V/24V - 27W, 15 lamps sync, complete waterproof casted, operating temp. -30°C - +60°C, ADR appr., Fixation: 3 bolt</p>		<p>Warnfunktionen Flash Patterns</p> <ul style="list-style-type: none"> Single flash (R65) Double flash Quick (R65) Double flash Slow Triple flash Quad flash (R65) Mega flash Rotate Off
40 599 011	1	<p>LED Kennleuchte PRO-MULTI-FLASH II dito, blau</p> <p>LED Beacon PRO-MULTI-FLASH II blue</p>		
40 599 201	1	<p>LED Kennleuchte PRO-MULTI-FLASH II gemäß ECE R65, R10, ultraflache Bauform, 7 Warnfunktionen, 12/24V - 27W, Leuchte wasserdicht verschlossen, Einsatztemperatur -30°C - +60°C Befestigung: flexibler Rohstutzen</p> <p>LED Beacon PRO-MULTI-FLASH II according to ECE R65, R10, ultra low profile, 7 flash pattern, 12V/24V - 27W, complete waterproof casted, operating temp. -30°C - +60°C, Fixation: flex. Pole Mount</p>	<p>Auswahlschalter Flash Pattern Selector</p>	<p>Warnfunktionen Flash Patterns</p> <ul style="list-style-type: none"> Single flash (R65) Double flash Quick (R65) Double flash Slow Triple flash Quad flash (R65) Mega flash Rotate Off
40 599 211	1	<p>LED Kennleuchte PRO-MULTI-FLASH II dito, blau</p> <p>LED Beacon PRO-MULTI-FLASH II blue</p>		
40 599 301	1	<p>LED Kennleuchte PRO-MULTI-FLASH II gemäß ECE R65, R10, ultraflache Bauform, 7 Warnfunktionen, 12/24V - 27W, Leuchte wasserdicht verschlossen, Einsatztemperatur -30°C - +60°C Befestigung: Magnet</p> <p>LED Beacon PRO-MULTI-FLASH II according to ECE R65, R10, ultra low profile, 7 flash pattern, 12V/24V - 27W, complete waterproof casted, operating temp. -30°C - +60°C, Fixation: Magnetic</p>	<p>Auswahlschalter Flash Pattern Selector</p>	<p>Warnfunktionen Flash Patterns</p> <ul style="list-style-type: none"> Single flash (R65) Double flash Quick (R65) Double flash Slow Triple flash Quad flash (R65) Mega flash Rotate Off
40 599 311	1	<p>LED Kennleuchte PRO-MULTI-FLASH II dito, blau</p> <p>LED Beacon PRO-MULTI-FLASH II blue</p>		

LED Kennleuchte

LED Beacon

Typ: PRO-MULTI-FLASH II



Artikel-Nr. Reference-No.	VE QTY	Beschreibung Description	LED Kennleuchten LED Beacons	gemäß ECE R65 according to ECE R65
40 599 701	1	<p>LED Kennleuchte PRO-MULTI-FLASH II gemäß ECE R65, R10, ultraflache Bauform, 7 Warnfunktionen, 12/24V - 27W, 15 Leuchten synchronisierbar, Leuchte wasserdicht verschlossen, ADR geprüft, Einsatztemperatur -30°C - +60°C Befestigung: 3 - Punkt</p> <p><i>LED Beacon PRO-MULTI-FLASH II according to ECE R65, R10, ultra low profile, 7 flash pattern, 12V/24V - 27W, 15 lamps sync, complete waterproof casted, operating temp. -30°C - +60°C, ADR appr., Fixation: 3 bolt</i></p>		<p>Warnfunktionen Flash Patterns Single flash (R65) Double flash Quick (R65) Double flash Slow Triple flash Quad flash (R65) Mega flash Rotate Off</p>
40 599 801	1	<p>LED Kennleuchte PRO-MULTI-FLASH II gemäß ECE R65, R10, ultraflache Bauform, 7 Warnfunktionen, 12/24V - 27W, Leuchte wasserdicht verschlossen, Einsatztemperatur -30°C - +60°C Befestigung: flexibler Rohstutzen</p> <p><i>LED Beacon PRO-MULTI-FLASH II according to ECE R65, R10, ultra low profile, 7 flash pattern, 12V/24V - 27W, complete waterproof casted, operating temp. -30°C - +60°C, Fixation: flex. Pole Mount</i></p>	<p>Auswahlschalter Flash Pattern Selector</p>	<p>Warnfunktionen Flash Patterns Single flash (R65) Double flash Quick (R65) Double flash Slow Triple flash Quad flash (R65) Mega flash Rotate Off</p>
40 599 901	1	<p>LED Kennleuchte PRO-MULTI-FLASH II gemäß ECE R65, R10, ultraflache Bauform, 7 Warnfunktionen, 12/24V - 27W, Leuchte wasserdicht verschlossen, Einsatztemperatur -30°C - +60°C Befestigung: Magnet</p> <p><i>LED Beacon PRO-MULTI-FLASH II according to ECE R65, R10, ultra low profile, 7 flash pattern, 12V/24V - 27W, complete waterproof casted, operating temp. -30°C - +60°C, Fixation: Magnetic</i></p>	<p>Auswahlschalter Flash Pattern Selector</p>	<p>Warnfunktionen Flash Patterns Single flash (R65) Double flash Quick (R65) Double flash Slow Triple flash Quad flash (R65) Mega flash Rotate Off</p>

LED Kennleuchte

LED Beacon

Typ: PRO-POWER-FLASH

Artikel-Nr. Reference-No.	VE QTY	Beschreibung Description	LED Kennleuchten LED Beacons	gemäß ECE R65 according to ECE R65
40 551 001	1	<p>LED Kennleuchte PRO-POWER-FLASH gemäß ECE R65, R10 & SAE, 8-POWER-LED's, 12V/24V, max. Verbrauch 700mA, Lichthaube aus bruchfestem PC, Befestigung: 3 - Punkt Warnfunktion: blitzend</p> <p><i>LED Beacon PRO-POWER-FLASH according to ECE R65, R10 & SAE, 8-POWER-LED's, 12V/24V, max. consumption 700mA, lens made of PC, very low profile Fixation: 3 bolt flash pattern: flashing</i></p>		
40 551 201	1	<p>LED Kennleuchte PRO-POWER-FLASH gemäß ECE R65, R10 & SAE, 8-POWER-LED's, 12V/24V, max. Verbrauch 700mA, Lichthaube aus bruchfestem PC, Befestigung: flexibler Rohstutzen Warnfunktion: blitzend</p> <p><i>LED Beacon PRO-POWER-FLASH according to ECE R65, R10 & SAE, 8-POWER-LED's, 12V/24V - 9W, max. consumption 700mA, lens made of PC, very low profile Fixation: flex. Pole Mount flash pattern: flashing</i></p>		
40 551 301	1	<p>LED Kennleuchte PRO-POWER-FLASH gemäß ECE R65, R10 & SAE, 8-POWER-LED's, 12V/24V, max. Verbrauch 700mA, Lichthaube aus bruchfestem PC, Befestigung: Vakuum/Magnet Warnfunktion: blitzend</p> <p><i>LED Beacon PRO-POWER-FLASH according to ECE R65, R10 & SAE, 8-POWER-LED's, 12V/24V - 9W, max. consumption 700mA, lens made of PC, very low profile Fixation: Vacuum/Magnetic flash pattern: flashing</i></p>		
40 551 101	1	Ersatzhaube für LED Kennleuchte <i>Lens for LED Beacon</i>		
50 024 000	1	Montage-Adapter für Dachbefestigung <i>Rubber base for roof fixation</i>		<p>3,6° Neigung/inclination</p>

LED Kennleuchte

LED Beacon

Typ: PRO-ROTA-FLASH



Artikel-Nr. Reference-No.	VE QTY	Beschreibung Description	LED Kennleuchten LED Beacons	gemäß ECE R65 according to ECE R65
40 551 401	1	<p>LED Kennleuchte PRO-ROTA-FLASH gemäß ECE R65, R10, 8-POWER-LED's, 12V/24V, max. Verbrauch 700mA, Lichthaube aus bruchfestem PC, Befestigung: 3 - Punkt Warnfunktion: rotierend</p> <p>LED Beacon PRO-ROTA-FLASH according to ECE R65, R10, 8-POWER-LED's, 12V/24V, max. consumption 700mA, lens made of PC, very low profile Fixation: 3 bolt flash pattern: rotating</p>		
40 551 501	1	<p>LED Kennleuchte PRO-ROTA-FLASH gemäß ECE R65, R10, 8-POWER-LED's, 12V/24V, max. Verbrauch 700mA, Lichthaube aus bruchfestem PC, Befestigung: flexibler Rohstutzen Warnfunktion: rotierend</p> <p>LED Beacon PRO-ROTA-FLASH according to ECE R65, R10, 8-POWER-LED's, 12V/24V - 9W, max. consumption 700mA, lens made of PC, very low profile Fixation: flex. Pole Mount flash pattern: rotating</p>		
40 551 601	1	<p>LED Kennleuchte PRO-ROTA-FLASH gemäß ECE R65, R10, 8-POWER-LED's, 12V/24V, max. Verbrauch 700mA, Lichthaube aus bruchfestem PC, Befestigung: Vakuum/Magnet Warnfunktion: rotierend</p> <p>LED Beacon PRO-ROTA-FLASH according to ECE R65, R10, 8-POWER-LED's, 12V/24V - 9W, max. consumption 700mA, lens made of PC, very low profile Fixation: Vacuum/Magnetic flash pattern: rotating</p>		
40 551 101	1	Ersatzhaube für LED Kennleuchte Lens for LED Beacon		
50 024 000	1	Montage-Adapter für Dachbefestigung Rubber base for roof fixation		<p>3,6° Neigung/inclination</p>

LED Kennleuchte

LED Beacon

Typ: PRO-SUPER-FLASH









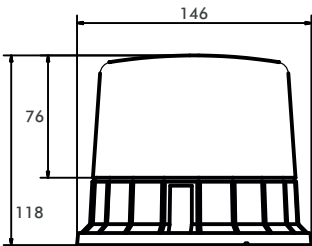

Artikel-Nr. Reference-No.	VE QTY	Beschreibung Description	LED Kennleuchten LED Beacons	gemäß ECE R65 according to ECE R65
40 570 001	1	<p>LED Kennleuchte PRO-SUPER-FLASH gemäß ECE R65, R10, 8-POWER-LED's, Einsatzbereich 12V/24V, max. Verbrauch 700mA, Lichthaube aus bruchfestem PC, Befestigung: 3 - Punkt Warnfunktion: blitzend</p> <p>LED Beacon PRO-SUPER-FLASH according to ECE R65, R10, 8-POWER-LED's, 12V/24V - 9W, max. consumption 700mA, lens made of PC, Fixation: 3 bolt flash pattern: flashing</p>		
40 570 201	1	<p>LED Kennleuchte PRO-SUPER-FLASH gemäß ECE R65, R10, 8-POWER-LED's, Einsatzbereich 12V/24V, max. Verbrauch 700mA, Lichthaube aus bruchfestem PC, Befestigung: flexibler Rohstutzen Warnfunktion: blitzend</p> <p>LED Beacon PRO-SUPER-FLASH according to ECE R65, R10, 8-POWER-LED's, 12V/24V - 9W, max. consumption 700mA, lens made of PC, Fixation: flex. Pole Mount flash pattern: flashing</p>		
40 570 301	1	<p>LED Kennleuchte PRO-SUPER-FLASH gemäß ECE R65, R10, 8-POWER-LED's, Einsatzbereich 12V/24V, max. Verbrauch 700mA, Lichthaube aus bruchfestem PC, Befestigung: Vakuum/Magnet Warnfunktion: blitzend</p> <p>LED Beacon PRO-SUPER-FLASH according to ECE R65, R10, 8-POWER-LED's, 12V/24V - 9W, max. consumption 700mA, lens made of PC, Fixation: Vacuum/Magnetic flash pattern: flashing</p>		
40 570 101	1	Ersatzhaube für LED Kennleuchte Lens for LED Beacon		
50 024 000	1	Montage-Adapter für Dachbefestigung Rubber base for roof fixation		

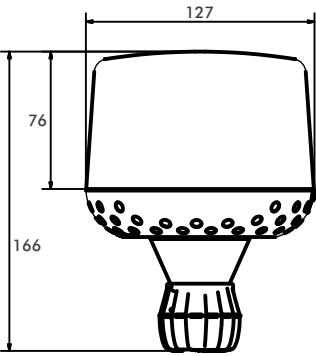
LED Kennleuchte

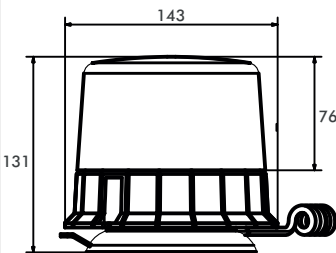
LED Beacon

Typ: PRO-ROTA-FLASH XL

Artikel-Nr. Reference-No.	VE QTY	Beschreibung Description	LED Kennleuchten LED Beacons	gemäß ECE R65 according to ECE R65
40 570 401	1	<p>LED Kennleuchte PRO-ROTA-FLASH XL gemäß ECE R65, R10, 8-POWER-LED's, Einsatzbereich 12V/24V, max. Verbrauch 700mA, Lichthaube aus bruchfestem PC, Befestigung: 3 - Punkt Warnfunktion: rotierend</p> <p><i>LED Beacon PRO-ROTA-FLASH XL according to ECE R65, R10, 8-POWER-LED's, 12V/24V - 9W, max. consumption 700mA, lens made of PC, Fixation: 3 bolt flash pattern: rotating light</i></p>		
40 570 501	1	<p>LED Kennleuchte PRO-ROTA-FLASH XL gemäß ECE R65, R10, 8-POWER-LED's, Einsatzbereich 12V/24V, max. Verbrauch 700mA, Lichthaube aus bruchfestem PC, Befestigung: flexibler Rohstutzen Warnfunktion: rotierend</p> <p><i>LED Beacon PRO-ROTA-FLASH XL according to ECE R65, R10, 8-POWER-LED's, 12V/24V - 9W, max. consumption 700mA, lens made of PC, Fixation: flex. Pole Mount flash pattern: rotating light</i></p>		
40 570 601	1	<p>LED Kennleuchte PRO-ROTA-FLASH XL gemäß ECE R65, R10, 8-POWER-LED's, Einsatzbereich 12V/24V, max. Verbrauch 700mA, Lichthaube aus bruchfestem PC, Befestigung: Vakuum/Magnet Warnfunktion: rotierend</p> <p><i>LED Beacon PRO-ROTA-FLASH XL according to ECE R65, R10, 8-POWER-LED's, 12V/24V - 9W, max. consumption 700mA, lens made of PC, Fixation: Vacuum/Magnetic flash pattern: rotating light</i></p>		
40 570 101	1	<p>Ersatzhaube für LED Kennleuchte <i>Lens for LED Beacon</i></p>		
50 024 000	1	<p>Montage-Adapter für Dachbefestigung <i>Rubber base for roof fixation</i></p>		<p>3,6° Neigung/inclination</p> 

LED Kennleuchte

LED Beacon

Typ: PRO-ECO-FLASH II

Artikel-Nr. Reference-No.	VE QTY	Beschreibung Description	LED Kennleuchten LED Beacons	
40 665 701	1	<p>LED Kennleuchte PRO-ECO-FLASH II EMV geprüft ECE R10, 32 LED's, Einsatzbereich 10-30V, Lichthaube aus bruchfestem PC, Befestigung: 3 - Punkt</p> <p><i>LED Beacon PRO-ECO-FLASH II EMC approved ECE R10, 32 LED's, 10-30V, lens made of PC, Fixation: 3 bolt</i></p>		<p>Warnfunktionen Flash Patterns Rotation Quint Flash Mega flash Off</p>
40 665 801	1	<p>LED Kennleuchte PRO-ECO-FLASH II EMV geprüft ECE R10, 32 LED's, Einsatzbereich 10-30V, Lichthaube aus bruchfestem PC, Befestigung: flexibler Rohstutzen</p> <p><i>LED Beacon PRO-ECO-FLASH II EMC approved ECE R10, 32 LED's, 10-30V, lens made of PC, Fixation: flex. Pole Mount</i></p>		
40 665 901	1	<p>LED Kennleuchte PRO-ECO-FLASH II EMV geprüft ECE R10, 32 LED's, Einsatzbereich 10-30V, Lichthaube aus bruchfestem PC, Befestigung: Magnet</p> <p><i>LED Beacon PRO-ECO-FLASH II EMC approved ECE R10, 32 LED's, 10-30V, lens made of PC, Fixation: Magnetic</i></p>	<p>Auswahlschalter Flash Pattern Selector</p>	<p>Warnfunktionen Flash Patterns Rotation Quint Flash Mega flash Off</p>

LED Kennleuchte

LED Beacon

Typ: PRO-FLASH II

Artikel-Nr. Reference-No.	VE QTY	Beschreibung Description	LED Kennleuchten LED Beacons	gemäß ECE R65 according to ECE R65
40 590 001	1	<p>LED Kennleuchte PRO-FLASH II Doppelblitzausführung, umschaltbar auf Drehlicht, gemäß ECE R65, R10, Lichthaube aus bruchfestem PC, Einsatzbereich 12V/24V, Befestigung: 3 - Punkt</p> <p><i>LED Beacon PRO-FLASH II, double flash version, switchable to simulated rotate, according to ECE R65, 12V/24V, lens made of unbreakable PC Fixation: 3 bolt</i></p>		
40 590 101	1	<p>Ersatzhaube gelb Lens amber</p>		
40 591 001	1	<p>LED Kennleuchte PRO-FLASH II Doppelblitzausführung, gemäß ECE R65, R10, Lichthaube aus bruchfestem PC, Einsatzbereich 12V/24V, Befestigung: Rohrstützen</p> <p><i>LED Beacon PRO-FLASH II, double flash version, according to ECE R65, 12V/24V, lens made of unbreakable PC Fixation: Pole Mount</i></p>		
40 590 101	1	<p>Ersatzhaube gelb Lens amber</p>		
40 592 001	1	<p>LED Kennleuchte PRO-FLASH II Doppelblitzausführung, gemäß ECE R65, R10, Lichthaube aus bruchfestem PC, Einsatzbereich 12V/24V, Befestigung: Flex. Rohrstützen</p> <p><i>LED Beacon PRO-FLASH II, double flash version, according to ECE R65, 12V/24V, lens made of unbreakable PC Fixation: Flex. Pole Mount</i></p>		
40 590 101	1	<p>Ersatzhaube gelb Lens amber</p>		
40 593 001	1	<p>LED Kennleuchte PRO-FLASH II Doppelblitzausführung, gemäß ECE R65, R10, Lichthaube aus bruchfestem PC, Einsatzbereich 12V/24V, Befestigung: Magnet</p> <p><i>LED Beacon PRO-FLASH II, double flash version, according to ECE R65, 12V/24V, lens made of unbreakable PC Fixation: Magnetic</i></p>		
40 590 101	1	<p>Ersatzhaube gelb Lens amber</p>		

LED Kennleuchte

LED Beacon

Typ: PRO-STROBE, PRO-FLAT-STROBE II

Artikel-Nr. Reference-No.	VE QTY	Beschreibung Description	LED Kennleuchten LED Beacons	gemäß ECE R65 according to ECE R65
40 694 001	1	<p>LED Kennleuchte PRO-STROBE, gemäß ECE R65, 9V - 36V, Verbrauch 12V/18W-1,5A, 24V/20W-0,84A, robustes Aluminium Druckgussgehäuse, Kabel 1,80m, ADR gepr., IP6K9K Befestigung: Anbau</p> <p>LED Beacon PRO-STROBE, according to ECE R65, 9V - 36V, consumption 12V/18W, 24V/20W, aluminium die cast housing, cable 1,80m, ADR approved, IP6K9K, surface mount</p>		
40 694 011	1	<p>LED Kennleuchte PRO-STROBE, dito, blau</p> <p>LED Beacon PRO-STROBE, blue</p>		
40 694 201	1	<p>LED Kennleuchte PRO-STROBE, gemäß ECE R65, 9V - 36V, Verbrauch 12V/18W-1,5A, 24V/20W-0,84A, robustes Aluminium Druckgussgehäuse, Kabel 1,80m, ADR gepr., IP6K9K Befestigung: Aufbau</p> <p>LED Beacon PRO-STROBE, according to ECE R65, 9V - 36V, consumption 12V/18W, 24V/20W, aluminium die cast housing, cable 1,80m, ADR approved, IP6K9K, bracket mount</p>		
40 694 211	1	<p>LED Kennleuchte PRO-STROBE, dito, blau</p> <p>LED Beacon PRO-STROBE, blue</p>		
NEW 40 589 001	1	<p>LED Kennleuchte PRO-FLAT-STROBE II, gemäß ECE R65 & ECE R10, ultraflache Bauform, 12 verschiedene Warnfunktionen, synchrone oder alternative Warnfunktion, wasserdicht vergossen, Kabel 0,25m, 12V/24V</p> <p>LED Beacon PRO-FLAT-STROBE II, amber, according to ECE R65, R10, extreme low profile, 12 flash patterns, synchronous or alternate flash, waterproof casted, cable 0,25m, 12V/24V</p>		
40 589 011	1	<p>LED Kennleuchte PRO-FLAT-STROBE II, dito, blau</p> <p>LED Beacon PRO-FLAT-STROBE II, blue</p>		

LED Kennleuchte

LED Beacon

Typ: PRO-MINI-STROBE, PRO-FLAT-STROBE II

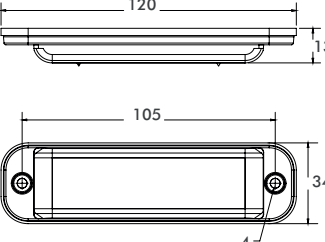
Artikel-Nr. Reference-No.	VE QTY	Beschreibung Description	LED Kennleuchten LED Beacons	gemäß ECE R65 according to ECE R65
40 506 001	1	LED Kennleuchte PRO-MINI-STROBE , gelb, mit integr. Steuergerät für synchrone oder alternative Warnfunktion, verkabelt, ADR, 12V/24V, Aufbauversion <i>LED Beacon PRO-MINI-STROBE, amber, integr. Power supply, synchronous or alternate flash, incl. cable, ADR-appr., 12/24V, surface mount version</i>	 	gelb/amber 12V - 20W / 24V - 35W blau/blue 12V - 25W / 24V - 35W 
40 506 011	1	LED Kennleuchte PRO-MINI-STROBE , dito, blau <i>LED Beacon PRO-MINI-STROBE, blue</i>	 	
40 505 001	1	LED Kennleuchte PRO-MINI-STROBE , gelb, mit integr. Steuergerät für synchrone oder alternative Warnfunktion, verkabelt, ADR, 12V/24V, Einbauversion <i>LED Beacon PRO-MINI-STROBE, amber, integr. Power supply, synchronous or alternate flash, incl. cable, ADR-appr., 12/24V, flush mount version</i>	 	gelb/amber 12V - 20W / 24V - 35W blau/blue 12V - 25W / 24V - 35W 
40 505 011	1	LED Kennleuchte PRO-MINI-STROBE , dito, blau <i>LED Beacon PRO-MINI-STROBE, blue</i>	 	Ausstattung/blanking 105mm x 38mm
NEW 40 589 021	1	LED Kennleuchte PRO-FLAT-STROBE II , blau & gelb, gemäß ECE R65 & ECE R10, ultraflache Bauform, 12 verschiedene Warnfunktionen, synchrone oder alternative Warnfunktion, wasserdicht vergossen, Kabel 0,21m, 12V/24V ADR geprüft <i>LED Beacon PRO-FLAT-STROBE II, amber & blue, according to ECE R65 & ECE R10, extreme low profile, 12 flash patterns, synchronous or alternate flash, waterproof casted, cable 0,21m, 12V/24V, ADR approved</i>	 	

LED Kennleuchte

LED Beacon



Artikel-Nr. Reference-No.	VE QTY	Beschreibung Description	LED Kennleuchten LED Beacons
40 594 001	1	<p>LED Kennleuchte gelb PRO-CORNER-STROBE, gemäß ECE R65 'X', 'HT', 'T' & ECE R10, 26 verschiedene Warnfunktionen, synchrone oder alternative Warnfunktion, wasserdicht vergossen, Kabel 0,5m, 12V/24V</p> <p><i>LED Beacon PRO-CORNER-STROBE, amber, according to ECE R65 'X', 'HT', 'T' & R10, 26 flash pattern, synchronous or alternate flash, water- proof casted, cable 0,5m, 12V/24V</i></p>	<p>360° Warnfunktion mit 4 PRO-CORNER-STROBE. Max. Abstand zwischen den Leuchten 10m</p> <p>360° warning coverage with 4 PRO-CORNER-STROBE. Max. distance between LED Beacons 10m</p>
40 552 501	1	<p>LED Kennleuchte gelb PRO-POWER-STROBE, gemäß ECE R65 & ECE R10, 10 verschiedene Warnfunktionen, synchrone oder alternative Warnfunktion, wasserdicht vergossen, Kabel 1,0m, 12V/24V</p> <p><i>LED Beacon PRO-POWER-STROBE, amber, according to ECE R65 & R10, 21 flash pattern, synchronous or alternate flash, waterproof casted, cable 1,0m, 12V/24V</i></p>	
40 507 501	1	<p>LED Kennleuchte gelb PRO-INTER-STROBE, gemäß ECE R65, R10, SAE, besonders flache Bauform, 10 Warnfunktionen, synchrone oder alternative Warnfunktion, wasserdicht vergossen, Kabel 0,5m, 12V/24V</p> <p><i>LED Beacon PRO-INTER-STROBE, amber, according to ECE R65, R10, SAE, very low profile, 16 flash pattern, synchronous or alternate flash, waterproof casted, cable 0,5m, 12V/24V</i></p>	
40 508 601	1	<p>LED Kennleuchte gelb PRO-MICRO-STROBE II, ECE R65, R10, 26 Warnfunktionen, synchrone/alternative Warnfunktion, Anbaueinheit, wasserdicht vergossen, Kabel 3,2m, 12V/24V</p> <p><i>LED Beacon PRO-MICRO-STROBE II, amber, ECE R65, R10, synchronous or alternate flash, 26 flash pattern, surface mount, waterproof casted, cable 3,2m, 12V/24V</i></p>	
40 508 901	1	<p>LED Kennleuchte gelb PRO-MICRO-STROBE II, dito. Ein-/Aufbauleuchte</p> <p><i>LED Beacon PRO-MICRO-STROBE II, flush or bracket mounted</i></p>	

LED Kennleuchte

LED Beacon



Artikel-Nr. Reference-No.	VE QTY	Beschreibung Description	LED Kennleuchten LED Beacons	
40 521 501	1	LED Kennleuchte PRO-MAXI-STROBE gelb, mit integr. Steuergerät für 24 Warnfunktionen, 9-30V, Kabel 0,75m, IP67, ECE R65, R10 Befestigung: Einbau oder Anbau <i>LED Directional Beacon PRO-MAXI-STROBE amber, integr. Power supply, 24 selectable flash pattern, 9-30V, cable 0,75m, IP67, ECE R65, R10 surface or bracket mount</i>		
40 521 511	1	LED Kennleuchte PRO-MAXI-STROBE blau <i>LED Directional Beacon PRO-MAXI-STROBE blue</i>		
40 596 001	1	LED Kennleuchte PRO-BATTERY-FLASH gelb, Einzelblitz/Rotierend, IP66, ECE R10, Magnetbefestigung, 4 x 1,5V AA Batterien *nicht enthalten <i>LED Beacon PRO-BATTERY-FLASH, amber, single flash/rotating, IP66, ECE R10, magnetic fixation, 4 x 1,5V AA batteries *not included</i>		
40 598 001	1	LED Kennleuchte PRO-INDU-FLASH für den industriellen Einsatz, gelb, 4-fach Blitz, 10-110V, IP66, ECE R10, Kabel 0,3m Befestigung: 3 Stehbolzen <i>LED Beacon PRO-INDU-FLASH, for industrial use, amber, quad flash, 10-110V, IP66, ECE R10, cable 0,3m Fixation: 3 Bolts</i>		
40 523 501	1	LED Kennleuchte für den industriellen Einsatz gelb, 4-fach Blitz, 10-110V, IP67, ECE R10, Kabel 0,35m Befestigung: 2 Stehbolzen <i>LED Beacon for industrial use, amber, Multivoltage 10-110V, IP67, ECE R10, cable 0,35m Fixation: 2 Bolts</i>		

Rundumkennleuchte

Rotating Beacon



Typ: **EVOLUTION LINE**

Artikel-Nr. Reference-No.	VE QTY	Beschreibung Description	Rundumkennleuchten Rotating Beacons	FF-Technik P 14,5s / H1 Riemenantrieb/Belt Drive
40 555 001	1	Rundumkennleuchte EVOLUTION LINE 12V / 24Volt verwendbar Funkentstörfilter Befestigung: 3 Stehbolzen M6 <i>Rotating Beacon 12V / 24 Volt Fixation: 3 Bolts M6</i>		
40 557 001	1	Rundumkennleuchte EVOLUTION LINE 12V / 24Volt verwendbar Funkentstörfilter Befestigung: Rohrstützen <i>Rotating Beacon 12V / 24 Volt Fixation: Pole Mount</i>		
40 558 001	1	Rundumkennleuchte EVOLUTION LINE 12V / 24Volt verwendbar Funkentstörfilter Befestigung: Vakuum/Magnet <i>Rotating Beacon 12V / 24 Volt Fixation: Vacuum/Magnetic</i>		
40 559 001	1	Rundumkennleuchte EVOLUTION LINE 12V / 24Volt verwendbar Funkentstörfilter Befestigung: Flex.Rohrstützen <i>Rotating Beacon 12V / 24 Volt Fixation: Flex.Pole Mount</i>		
50 086 000	1	Ersatzmodul für Rundumkennleuchte <i>Module for Rotating Beacon</i>		
40 555 101	1	Ersatzhaube gelb <i>Lens amber</i>		
40 525 500	1	Treibriemen 10 cm für Rundum- kennl. Evolution-/Standard Line <i>Belt 10cm for Rotating Beacon Evolution-/Standard Line</i>		
50 307 012	1	Glühlampe H1 12V/55W <i>Bulb H1 12V/55W</i>		
50 307 024	1	Glühlampe H1 24V/70W <i>Bulb H1 24V705W</i>		

Rundumkennleuchte

Rotating Beacon

Typ: **PRO-EUROLINE**

Artikel-Nr. Reference-No.	VE QTY	Beschreibung Description	Rundumkennleuchten Rotating Beacons	P 14,5s / H1 Riemenantrieb/Belt Drive
40 501 001	1	Rundumkennleuchte PRO-EUROLINE 12V / 24Volt verwendbar, Lichthaube bruchfest aus PC Befestigung: 3 Stehbolzen <i>Rotating Beacon, Lens made of unbreakable PC, 12V / 24 Volt Fixation: 3 Bolts</i>		
40 501 101	1	Ersatzhaube gelb <i>Lens amber</i>		
40 502 001	1	Rundumkennleuchte PRO-EUROLINE 12V / 24Volt verwendbar, Lichthaube bruchfest aus PC Befestigung: Rohrstützen <i>Rotating Beacon, Lens made of unbreakable PC, 12V / 24 Volt Fixation: Pole Mount</i>		
40 501 101	1	Ersatzhaube gelb <i>Lens amber</i>		
40 503 001	1	Rundumkennleuchte PRO-EUROLINE 12V / 24Volt verwendbar, Lichthaube bruchfest aus PC Befestigung: Flex.Rohrstützen <i>Rotating Beacon, Lens made of unbreakable PC, 12V / 24 Volt Fixation: Flex.Pole Mount</i>		
40 501 101	1	Ersatzhaube gelb <i>Lens amber</i>		
40 504 001	1	Rundumkennleuchte PRO-EUROLINE 12V / 24Volt verwendbar, Lichthaube bruchfest aus PC Befestigung: Vakuum/Magnet <i>Rotating Beacon, Lens made of unbreakable PC, 12V / 24 Volt Fixation: Vacuum/Magnetic</i>		
40 501 101	1	Ersatzhaube gelb <i>Lens amber</i>		
50 307 012	1	Glühlampe H1 12V/55W <i>Bulb H1 12V/55W</i>		
50 307 024	1	Glühlampe H1 24V/70W <i>Bulb H1 24V705W</i>		
40 501 500	1	Gummiunterlage für Rundum- kennleuchte 40 501 001 <i>Rubber base for beacon 40 501 001</i>		

Xenon Blitz-Kennleuchte

Xenon Beacon



Artikel-Nr. Reference-No.	VE QTY	Beschreibung Description	Xenon Blitz-Kennleuchten Xenon Beacons	
40 565 201	1	Blitz-Kennleuchte, gemäß ECE R65, Doppelblitz-Ausführung 12V / 24Volt verwendbar, Befestigung: 3 Stehbolzen M6 <i>Xenon Beacon, according to ECE R65, double flash version, 12V / 24Volt Fixation: 3 Bolts M6</i>		
50 067 007	1	Ersatz-Xenon Röhre für Blitz-Kennleuchte 40 565 201 <i>Xenon Tube for Xenon Beacon 40 565 201</i>		
40 676 001	1	Blitz-Kennleuchte, Einzelblitz-Ausführung 12V - 24Volt, 8W, IP65 Befestigung: 3 Stehbolzen M6 <i>Xenon Beacon, single flash version, 12V - 24Volt, 8W, IP65 Fixation: 3 Bolts M6</i>		
40 677 001	1	Blitz-Kennleuchte, Einzelblitz-Ausführung 12V - 24Volt, 8W, IP65 Befestigung: Rohrstützen <i>Xenon Beacon, single flash version, 12V - 24Volt, 8W, IP65 Fixation: Pole Mount</i>		
40 678 001	1	Blitz-Kennleuchte, Einzelblitz-Ausführung 12V - 24Volt, 8W, IP65 Befestigung: Magnet <i>Xenon Beacon, single flash version, 12V - 24Volt, 8W, IP65 Fixation: Magnetic</i>		
40 676 101	1	Erstzhaube gelb <i>Lens amber</i>		

Aufsteckrohr

Pole Mount Bracket

Artikel-Nr. Reference-No.	VE QTY	Beschreibung Description	Aufsteckrohre Pole Mount Brackets	
50 012 000	1	Aufsteckrohr für Rundumkennleuchten zum anschweißen, Steckdose DIN 72 591, 1-polig <i>Welded fixing bracket for rotating beacons, socket DIN 72 591, 1-pole</i>		
50 012 100	1	Aufsteckrohr dito., 2-polig <i>Welded fixing bracket dito., 2-poles</i>		
50 013 000	1	Aufsteckrohr für Rundumkennleuchten zum anschrauben, Steckdose DIN 72 591, 1-polig <i>Screw fixing bracket for rotating beacons, socket DIN 72 591, 1-pole</i>		
50 013 100	1	Aufsteckrohr dito., 2-polig <i>Screw fixing bracket dito., 2-poles</i>		
50 011 000	1	Aufsteckrohr für Rundumkennleuchten, 360° schwenkbar, in 4 Positionen arretierbar, DIN 72 591, 1-polig <i>Pole Mount bracket 360° rotatable, lockable in 4 positions, screw fixing, socket DIN 72 591, 1-pole</i>		
50 033 000	1	Aufsteckrohr für Rundumkennleuchten, Flanschbefestigung, Steckdose DIN 72 591, 1-polig <i>Straight fixing bracket for rotating beacons, socket DIN 72 591, 1-pole</i>		
50 034 000	1	Aufsteckrohr für Rundumkennleuchten, Winkelbefestigung, Steckdose DIN 72 591, 1-polig <i>Side fixing bracket for rotating beacons, socket DIN 72 591, 1-pole</i>		
50 035 000	1	Aufsteckrohr für Rundumkennleuchten, schwenkbar, Steckdose DIN 72 591, 1-polig <i>Fold down fixing bracket for rotating beacons, socket DIN 72 591, 1-pole</i>		
50 014 000	2	Steckdose 1-polig, DIN 72 591 für Aufsteckrohre <i>socket 1-pole, for fixing brackets</i>		
50 014 100	2	Steckdose 2-polig, DIN 72 591 für Aufsteckrohre <i>socket 2-poles, for fixing brackets</i>		50 014 100



LED Optische Warnleuchte

LED Lightbar

Typ: **PRO-MICRO-BAR II**











Artikel-Nr. Reference-No.	VE QTY	Beschreibung Description	Optische Warnleuchten Lightbars	LED Technik LED Technology
40 515 001	1	<p>LED Warnleuchte PRO-MICRO-BAR II extrem flache Bauform Warnleuchte aus bruchfestem Polycarbonat, 26 verschiedene Warnfunktionen, verkabelt, 12V/24V, Kabellänge 3,0m, ECE R65 & ECE R10 gepr. Befestigung: 1-Punktbefestigung</p> <p><i>LED Lightbar PRO-MICRO-BAR II very low profile, lightbar made of unbreakable polycarbonate, 26 flash patterns, cabled, 12V/24V, ECE R65 & ECE R10 approved, cable 3,0m Fixation: 1 Bolt Fixation</i></p>		
40 515 011	1	<p>LED Warnleuchte PRO-MICRO-BAR II dito, blau</p> <p><i>LED Lightbar PRO-MICRO-BAR II blue</i></p>		
40 515 701	1	<p>LED Warnleuchte PRO-MICRO-BAR II dito, klare Lichthaube</p> <p><i>LED Lightbar PRO-MICRO-BAR II clear lens</i></p>		
40 515 201	1	<p>LED Warnleuchte PRO-MICRO-BAR II extrem flache Bauform Warnleuchte aus bruchfestem Polycarbonat, 26 verschiedene Warnfunktionen, verkabelt, 12V/24V, Kabellänge 3,0m, ECE R65 & ECE R10 gepr. Befestigung: Magnetbefestigung</p> <p><i>LED Lightbar PRO-MICRO-BAR II very low profile, lightbar made of unbreakable polycarbonate, 26 flash patterns, cabled, 12V/24V, ECE R65 & ECE R10 approved, cable 3,0m Fixation: Magnetic Fixation</i></p>		
40 515 211	1	<p>LED Warnleuchte PRO-MICRO-BAR II dito, blau</p> <p><i>LED Lightbar PRO-MICRO-BAR II blue</i></p>		
40 515 901	1	<p>LED Warnleuchte PRO-MICRO-BAR II dito, klare Lichthaube</p> <p><i>LED Lightbar PRO-MICRO-BAR II clear lens</i></p>		<p>Auswahlschalter Flash Pattern Selector</p> <p>An/Aus Power On/Off</p>

LED Optische Warnleuchte

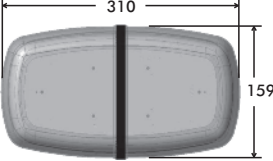
LED Lightbar

Typ: PRO-COMPACT-BAR

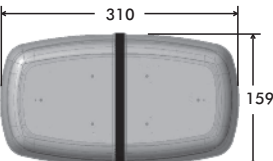

Artikel-Nr. Reference-No.	VE QTY	Beschreibung Description	Optische Warnleuchten Lightbars	LED Technik LED Technology
40 597 001	1	<p>LED Warnleuchte PRO-COMPACT-BAR integrierte Spiegeloptik, extrem flache Bauform Lichtscheibe aus bruchfestem Polycarbonat, 8 verschiedene Warnfunktionen, synchronisierbar, Kabel 3,0m, inkl. Auswahlschalter, 12V/24V, ECE R65 & R10 gepr. Befestigung: 2-Punktbefestigung</p> <p><i>LED Lightbar PRO-COMPACT-BAR very low profile, lens made of unbreakable polycarbonate, 8 flash patterns, syncable, cable 3,0m, incl. selector switch, 12V/24V, ECE R65 & R10 appr. Fixation: 2 Bolts Fixation</i></p>	   <p>Auswahlschalter Flash Pattern Selector</p> <p>An/Aus Power On/Off</p>	  <p>310</p> <p>159</p> <p>75</p>
40 597 201	1	<p>LED Warnleuchte PRO-COMPACT-BAR integrierte Spiegeloptik, extrem flache Bauform Lichtscheibe aus bruchfestem Polycarbonat, 8 verschiedene Warnfunktionen, synchronisierbar, Kabel 3,0m, inkl. Auswahlschalter, 12V/24V, ECE R65 & R10 gepr. Befestigung: Magnet</p> <p><i>LED Lightbar PRO-COMPACT-BAR very low profile, lens made of unbreakable polycarbonate, 8 flash patterns, syncable, cable 3,0m, incl. selector switch, 12V/24V, ECE R65 & R10 appr. Fixation: Magnetic</i></p>	   <p>Auswahlschalter Flash Pattern Selector</p> <p>An/Aus Power On/Off</p>	  <p>310</p> <p>159</p> <p>75</p>

LED Warnanlage

LED Lightbar

Typ: **PRO-MULTI-BAR II**



Artikel-Nr. Reference-No.	VE QTY	LED Warnanlage PRO-MULTI-BAR II - 108 - 162 gelben Hochleistungs-LED's - 12V/24V - Aerodynamisches, ultraflaches Design - Lichthauben aus bruchfestem PC - inkl. Onboard Steuermodul, 29 Warnfunktionen - Befestigungskit für variablen Anbau - Komplett verkabelt, ECE R65 & R10 geprüft	LED Lightbar PRO-MULTI-BAR II - 108 - 162 amber high power LED's - 12V/24V - Aerodynamic, ultra low profile design - Polycarbonate moulded lens - Onboard Controller included, 29 flash pattern - Fixationkit for variable mount - Complete cabled, ECE R65 & R10 approved
40 640 501	1	12V 24V Länge/Length: 852mm	Breite/Width: 300mm Höhe/Height: 39mm
40 641 501	1	12V 24V Länge/Length: 1172mm	Breite/Width: 300mm Höhe/Height: 39mm
40 642 501	1	12V 24V Länge/Length: 1492mm	Breite/Width: 300mm Höhe/Height: 39mm
40 643 501	1	12V 24V Länge/Length: 1812mm	Breite/Width: 300mm Höhe/Height: 39mm

Weitere Längen auf Anfrage

Further Length on request

LED Warnanlage

LED Lightbar

Typ: **PRO-SUPER-BAR**



Artikel-Nr. Reference-No.	VE QTY	LED Warnanlage PRO-SUPER-BAR - 128 - 200 gelbe Hochleistungs-LED's - 12V/24V - Besonders flache Bauform - Lichthauben aus bruchfestem PC - 10 Warnfunktionen - Befestigung: 4 Stehbolzen - Komplett verkabelt, ECE R65 & ECE R10 geprüft	LED Lightbar PRO-SUPER-BAR - 128 - 200 amber high power LED's - 12V/24V - Very low profile - Polycarbonate moulded lens - 10 flash pattern - Fixation: 4 Bolts - Complete cabled, ECE R65 & ECE R10 approved
40 600 001	1	12V 24V Länge/Length: 980mm	Breite/Width: 326mm Höhe/Height: 43mm
40 601 001	1	12V 24V Länge/Length: 1200mm	Breite/Width: 326mm Höhe/Height: 43mm
40 602 001	1	12V 24V Länge/Length: 1420mm	Breite/Width: 326mm Höhe/Height: 43mm
40 603 001	1	12V 24V Länge/Length: 1640mm	Breite/Width: 326mm Höhe/Height: 43mm

Weitere Längen auf Anfrage

Further Length on request

LED Warnanlage

LED Lightbar

Typ: PRO-ROTALED II

Artikel-Nr. Reference-No.	VE QTY	LED Warnanlage PRO-ROTALED II - 2 LED Module mit Hochleistungsreflektoren - Einsatzbereich 12/24V - max. Verbrauch 12V-1,4A, 24V-0,8A - Lichthauben aus bruchfestem PC - Schrifffeld opal, beleuchtbar - Befestigung: 4 Stehbolzen inkl. Gummipuffer - Kabel 3m, ECE R65 & ECE R10 geprüft	LED Lightbar PRO-ROTALED II - 2 Rotating LED modules - Multivoltage 12/24V - max. consumption 12V-1,4A, 24V-0,8A - Polycarbonate moulded lens - Center opal, illuminated - Fixation: 4 Bolts incl. shock absorbers - Cable 3m, ECE R65 & ECE R10 approved			
40 616 501	1	12V 24V	Länge/Length: 1054mm	Breite/Width: 220mm	Höhe/Height: 82mm	
40 617 501	1	12V 24V	Länge/Length: 1246mm	Breite/Width: 220mm	Höhe/Height: 82mm	
40 621 501	1	12V 24V	Länge/Length: 1585mm	Breite/Width: 220mm	Höhe/Height: 82mm	

Weitere Längen auf Anfrage

Further Length on request



Artikel-Nr. Reference-No.	VE QTY	LED Warnanlage PRO-ROTALED II - 4 LED Module mit Hochleistungsreflektoren - Einsatzbereich 12/24V - max. Verbrauch 12V-2,8A, 24V-1,6A - Lichthauben aus bruchfestem PC - Schrifffeld opal, beleuchtbar - Befestigung: 4 Stehbolzen inkl. Gummipuffer - Kabel 3m, ECE R65 & ECE R10 geprüft	LED Lightbar PRO-ROTALED II - 4 Rotating LED modules - Multivoltage 12/24V - max. consumption 12V-2,8A, 24V-1,6A - Polycarbonate moulded lens - Center opal, illuminated - Fixation: 4 Bolts incl. shock absorbers - Cable 3m, ECE R65 & ECE R10 approved			
40 618 501	1	12V 24V	Länge/Length: 1246mm	Breite/Width: 220mm	Höhe/Height: 82mm	
40 619 501	1	12V 24V	Länge/Length: 1585mm	Breite/Width: 220mm	Höhe/Height: 82mm	

Weitere Längen auf Anfrage

Further Length on request

Rückstrahler rund
Rückstrahler rechteckig
Dreieckrückstrahler

Reflex Reflectors round
Reflex Reflectors rectangular
Triangle Reflex Reflectors

8.0 - 8.1
8.2 - 8.3
8.4

08



nächt**LICHT**

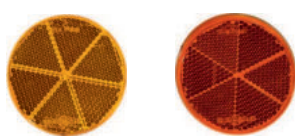
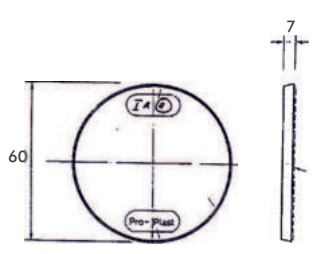
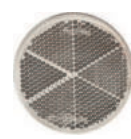
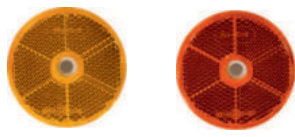
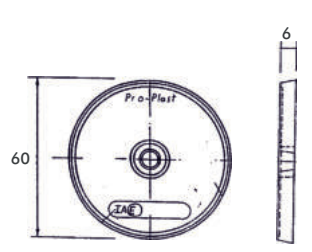
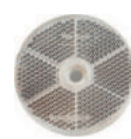
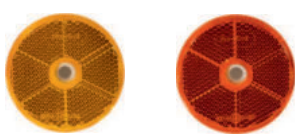
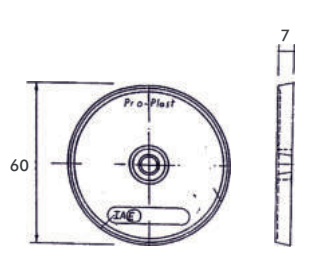
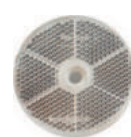
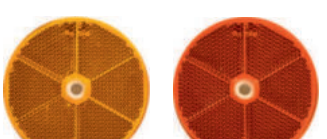
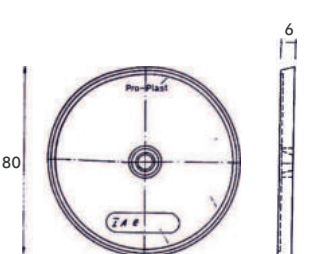
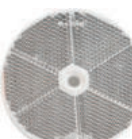

Rückstrahler

Reflex Reflector

Artikel-Nr. Reference-No.	VE QTY	Beschreibung Description	Rückstrahler Reflex Reflectors	
26 101 101 gelb / amber	25	Rückstrahler rund, 60mm, mit Selbstklebefolie		
26 101 102 rot / red	25	Reflex reflector round, 60mm with adhesive pad		
26 101 103 weiß / white	25			
26 108 001 gelb / amber	25	Rückstrahler rund, 60mm, Befestigungsloch 6mm		
26 108 002 rot / red	25	Reflex reflector round, 60mm, with hole 6mm		
26 108 003 weiß / white	25			
26 108 101 gelb / amber	25	Rückstrahler rund, 60mm, Befestigungsloch 6mm, mit Selbstklebefolie		
26 108 102 rot / red	25	Reflex reflector round, 60mm, hole 6mm, with adhesive pad		
26 108 103 weiß / white	25			
26 110 001 gelb / amber	25	Rückstrahler rund, 80mm, Befestigungsloch 6mm		
26 110 002 rot / red	25	Reflex reflector round, 80mm, with hole 6mm		
26 110 003 weiß / white	25			



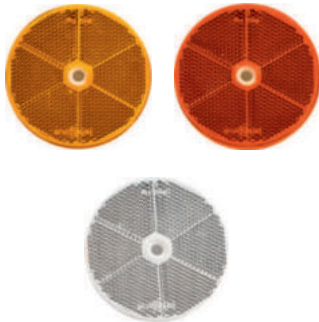
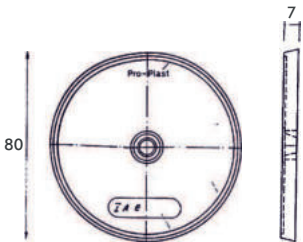
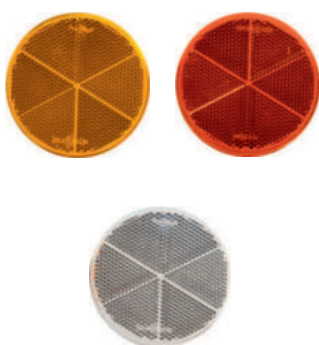
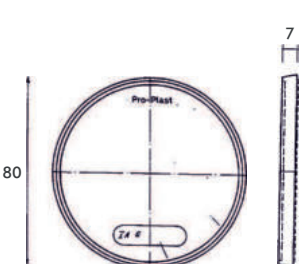

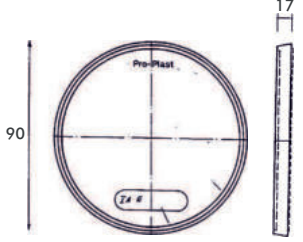





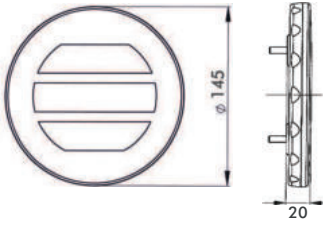

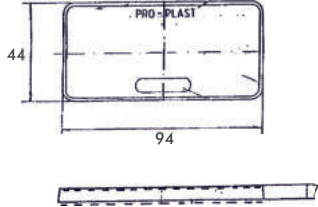
Rückstrahler

Reflex Reflector

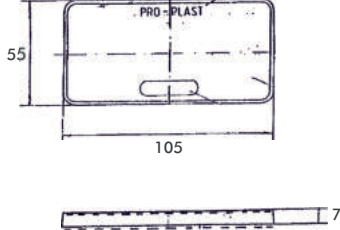
Artikel-Nr. Reference-No.	VE QTY	Beschreibung Description	Rückstrahler Reflex Reflectors	
26 110 101 gelb / amber	25	Rückstrahler rund, 80mm, Befestigungsloch 6mm, mit Selbstklebefolie		
26 110 102 rot / red	25	Reflex reflector round, 80mm, hole 6mm, with adhesive pad		
26 110 103 weiß / white	25			
26 111 101 gelb / amber	25	Rückstrahler rund, 80mm, mit Selbstklebefolie		
26 111 102 rot / red	25	Reflex reflector round, 80mm, with adhesive pad		
26 111 103 weiß / white	25			
26 111 202 rot / red	25	Rückstrahler rund, Außendurchmesser 90mm, Rückstrahlerfläche 80mm, Kunststofffassung mit Schraube und Mutter M5 Reflex reflector round, outside diameter 90mm, reflex reflector surface 80mm, plastic housing with screw and nut M5		



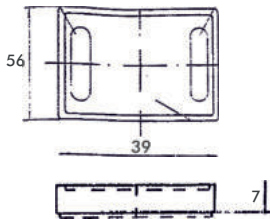







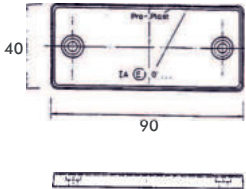

Rückstrahler

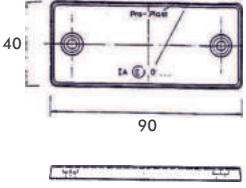
Reflex Reflector

Artikel-Nr. Reference-No.	VE QTY	Beschreibung Description	Rückstrahler Reflex Reflectors	
20 105 504 rot / red	1	Rückstrahler PRO-T-REFLEX , modernes Design in Klarglas-optik mit verspiegeltem Innengehäuse, Befestigung mittels 2 Stehbolzen <i>Reflex Reflector PRO-T-REFLEX, brilliant clear glas optic, fixation with 2 bolts</i>		
26 103 101 gelb / amber	25	Rückstrahler rechteckig, 94x44mm mit Selbstklebefolie		
26 103 102 rot / red	25	<i>Reflex reflector rectangular, 94x44mm with adhesive pad</i>		
26 103 103 weiß / white	25			
26 104 101 gelb / amber	25	Rückstrahler rechteckig, 105x55mm mit Selbstklebefolie		
26 104 102 rot / red	25	<i>Reflex reflector rectangular, 105x55mm with adhesive pad</i>		
26 104 103 weiß / white	25			
26 113 101 gelb / amber	25	Rückstrahler rechteckig, 56x39mm mit Selbstklebefolie		
26 113 102 rot / red	25	<i>Reflex reflector rectangular, 56x39mm with adhesive pad</i>		
26 113 103 weiß / white	25			

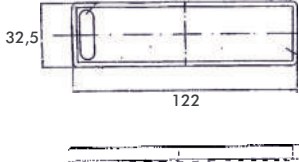

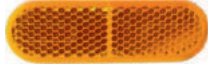
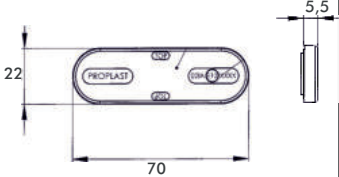

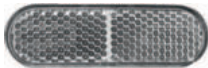
Rückstrahler

Reflex Reflector

Artikel-Nr. Reference-No.	VE QTY	Beschreibung Description	Rückstrahler Reflex Reflectors	
26 109 001 gelb / amber	25	Rückstrahler rechteckig 90x40mm, 2 Befestigungslöcher 4,2mm		
26 109 002 rot / red	25	Reflex reflector rectangular, 90x40mm, 2 holes 4,2mm		
26 109 003 weiß / white	25			
26 109 101 gelb / amber	25	Rückstrahler rechteckig 90x40mm, 2 Befestigungslöcher 4,2mm mit Selbstklebefolie		
26 109 102 rot / red	25	Reflex reflector rectangular, 90x40mm, 2 holes 4,2mm with adhesive pad		
26 109 103 weiß / white	25			
26 112 141 gelb / amber	25	Rückstrahler rechteckig, 122x32,5mm mit Selbstklebefolie		
26 112 142 rot / red	25	Reflex reflector rectangular, 122x32,5mm with adhesive pad		
20 017 101 gelb / amber	10	Rückstrahler PRO-CAN 70x22mm mit Selbstklebefolie		
20 017 102 rot / red	10	Reflex reflector PRO-CAN 70x22mm with adhesive pad		
20 017 103 weiß / white	10			

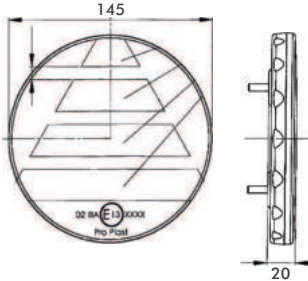
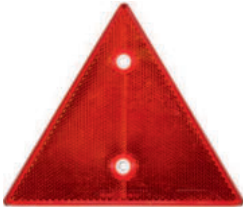
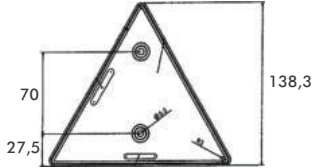
Rückstrahler

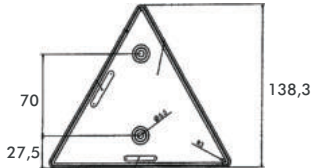
Reflex Reflector

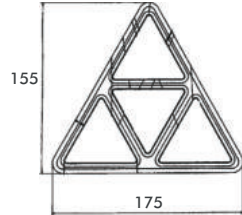
Artikel-Nr. Reference-No.	VE QTY	Beschreibung Description	Rückstrahler Reflex Reflectors	
20 105 004	1	<p>Dreieckrückstrahler PRO-REFLEX, modernes Design in Klarglas-optik mit verspiegeltem Innengehäuse, Befestigung mittels 2 Stehbolzen</p> <p><i>Triangle Reflex Reflector PRO-REFLEX, brilliant clear glass optic, fixation with 2 bolts</i></p>		
26 106 003	10	<p>Dreieckrückstrahler 2 Befestigungslöcher 5,2mm, weiße Rückplatte</p> <p><i>Triangle Reflex Reflector 2 holes 5,2mm, white housing</i></p>		
26 106 004	10	<p>Dreieckrückstrahler 2 Befestigungslöcher 5,2mm, schwarze Rückplatte</p> <p><i>Triangle Reflex Reflector 2 holes 5,2mm, black housing</i></p>		
26 107 104	10	<p>Dreieckrückstrahler 4-teilig, stabiles Kunststoffgehäuse, Schrauben und Muttern M5</p> <p><i>Triangle Reflex Reflector, solid plastic housing, screws and nuts M5</i></p>		

LED Kontrollgeräte
Blink-Modul für
Seitenmarkierungsleuchten
Fahrzeugleitungen
Steckverbinder

LED Control Gears
Blink-Unit for Sidemarker Lamp

9.0 - 9.8
9.9

Cable Kits
Connectors

9.10 - 9.15
9.16 - 9.18



*unend***LICHT**

LED Kontrollgerät

LED Control Gear

Typ: **PRO-LCG-ECO**



Artikel-Nr. Reference-No.	VE QTY	Beschreibung Description	LED Kontrollgeräte - Plug 'n Play LED Control Gears - Plug 'n Play
50 140 624 links/left 24V 	1	Vorkonfektioniertes LED Kontrollgerät PRO-LCG-ECO , 24 Volt überwacht die Blinklichtfunktion und kontrolliert die Brems-Schluss-Nebelschluss-Rückfahrlichtfunktion Eingang: 0,3m + 7-pol. AMP DIN Ausgang: 0,3m + 7-pol. AMP DIN 2 LCG pro Fahrzeug <i>Pre-assembled LED Control Gear PRO-LCG-ECO, 24 Volt monitors the dir. indicator function and is checking the funtions stop-tail-fog-reverse light,</i>	
50 140 625 rechts/right 24V 	1	Vorkonfektioniertes LED Kontrollgerät PRO-LCG-ECO , 24 Volt überwacht die Blinklichtfunktion und kontrolliert die Brems-Schluss-Nebelschluss-Rückfahrlichtfunktion Eingang: 0,3m + 7-pol. AMP DIN Ausgang: 0,3m + 7-pol. AMP DIN 2 LCG pro Fahrzeug <i>Pre-assembled LED Control Gear PRO-LCG-ECO, 24 Volt monitors the dir. indicator function and is checking the funtions stop-tail-fog-reverse light,</i>	
50 140 512 links/left 12V	1	Vorkonfektioniertes LED Kontrollgerät PRO-LCG-ECO , 12 Volt überwacht die Blinklichtfunktion und kontrolliert die Brems-Schluss-Nebelschluss-Rückfahrlichtfunktion Eingang: 0,3m + 5-pol. Bajonett, Ausgang: 0,3m + 5-pol. Bajonett, 2 LCG pro Fahrzeug <i>Pre-assembled LED Control Gear PRO-LCG-ECO, 12 Volt monitors the dir. indicator function and is checking the funtions stop-tail-fog-reverse light,</i>	
50 140 513 rechts/right 12V	1	Vorkonfektioniertes LED Kontrollgerät PRO-LCG-ECO , 12 Volt überwacht die Blinklichtfunktion und kontrolliert die Brems-Schluss-Nebelschluss-Rückfahrlichtfunktion Eingang: 0,3m + 5-pol. Bajonett, Ausgang: 0,3m + 5-pol. Bajonett, 2 LCG pro Fahrzeug <i>Pre-assembled LED Control Gear PRO-LCG-ECO, 12 Volt monitors the dir. indicator function and is checking the funtions stop-tail-fog-reverse light,</i>	

Anschlussmöglichkeit:
Fitting possibilities:
Plug 'n Play PRO-LGC-ECO

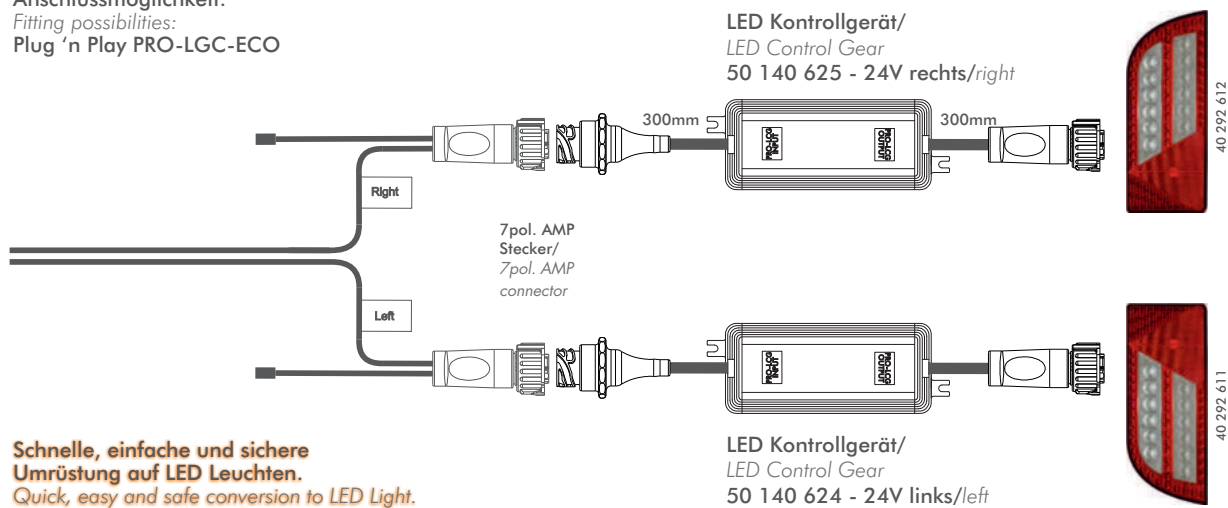

Schnelle, einfache und sichere Umrüstung auf LED Leuchten.
Quick, easy and safe conversion to LED Light.

LED Kontrollgerät

LED Control Gear

Typ: **PRO-LCG**



Artikel-Nr. Reference-No.	VE QTY	Beschreibung Description	LED Kontrollgeräte - Kabel ohne Stecker LED Control Gears - cable without connector
50 140 024 24V 	1	<p>Zentral LED Kontrollgerät PRO-LCG überwacht die Blinklichtfunktion und kontrolliert die Brems-Schluss-Nebelschluss-Rückfahrlichtfunktion, Kabel 8x1mm², Eingangsseite 3,5m open end, Ausgangsseite 1,25m open end ADR-geprüft,</p> <p>1 LCG pro Fahrzeug</p> <p>Abmessungen LCG: L 175 x B 80 x H 22mm</p> <p>24V Version ECE R10 geprüft</p> <p><i>Central LED Control Gear PRO-LCG monitors the dir. indicator function and is checking the functions stop-tail-fog-reverse light, cable 8x1mm², cable input 3,5m open end, cable output 1,25m open end, ADR approved,</i></p>	<p>Das PRO-LCG dient als Kontroll- und Vorschaltgerät vor LED Fahrzeugleuchten in 12V oder 24V Bordnetzen. Es ermöglicht dem im Zugfahrzeug vorhandenen Kontrollsystem zu erkennen und anzuzeigen, ob eine Blinkfunktion ausgefallen ist. Weiterhin verhindert es unkorrekte Ausfallmeldungen bei anderen Leuchtenfunktionen, die durch die geringe Stromaufnahme der LED Leuchten bedingt sind.</p> <p><i>The PRO-LCG is used as a control and ballast unit for LED vehicle lights in 12V or 24V onboard electrical systems. It enables the control system already installed in the towing vehicle to detect and display whether a direction indicator function has failed. Furthermore, it prevents incorrect failure signals for other light functions that are conditional on the lower power consumption of the LED lights.</i></p>
50 140 012 12V	1	<p>1 LCG pro Fahrzeug</p> <p>Sizes LCG: L 175 x W 80 x H 22mm</p> <p>24V Version ECE R10 approved</p>	
50 140 724 24V 	1	<p>Vorkonfektioniertes zentrales LED Kontrollgerät PRO-LCG überwacht die Blinklichtfunktion und kontrolliert die Brems-Schluss-Nebelschluss-Rückfahrlichtfunktion,</p> <p>Eingangsseite 0,3m + 8-pol. Buchsengehäuse, Ausgangsseite 0,3m + 8-pol. Stiftgehäuse,</p> <p>1 LCG pro Fahrzeug</p> <p><i>Pre-assembled Central LED Control Gear PRO-LCG monitors the dir. indicator function and is checking the functions stop-tail-fog-reverse light,</i></p>	
50 140 712 12V	1	<p>cable input 0,3m + 8-pin connector cable output 0,3m + 8-pin connector</p> <p>1 LCG pro Fahrzeug</p>	<p>8-pol FEP female FLRYY 8x1² 0,3m 8-pol FEP male FLRYY 8x1² 0,3m</p>





LCG Konfigurator

LCG Configuration

1. Eingangskabel auswählen
2. LED Kontrollgerät wählen
3. Ausgangskabel auswählen

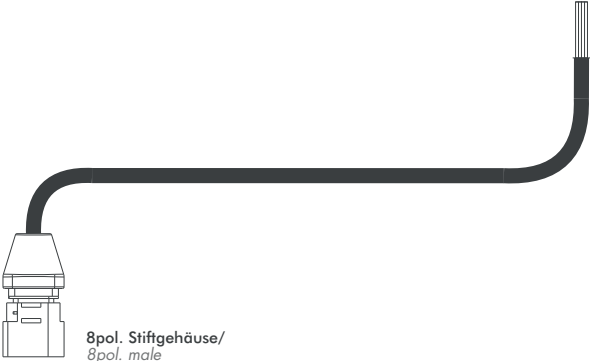
1. Choose Input cable
2. Choose LED Control Gear
3. Choose Output cable

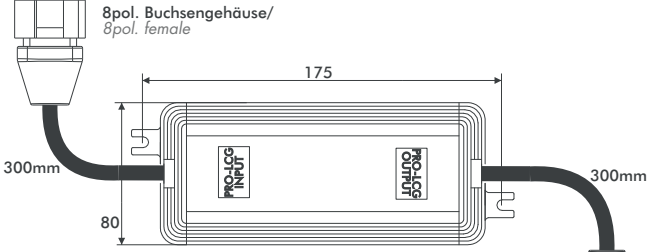

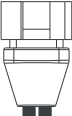
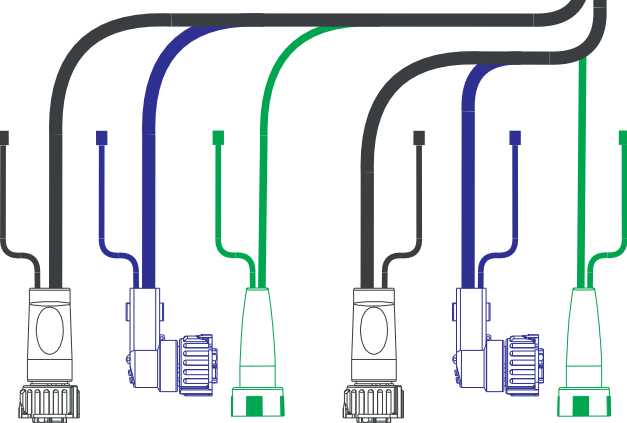
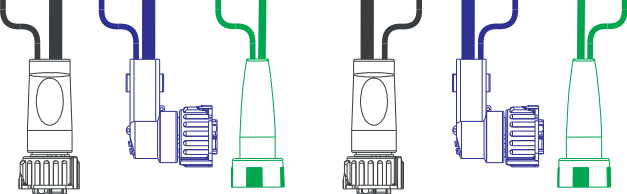
Artikel-Nr. Reference-No.	VE QTY	Beschreibung Description	Konfigurator LED Control Gears - cable with connector
50 042 408	1	Eingangskabel 8 polig Stiftgehäuse mit 4,0m open end <i>Input cable 8 poles male connector with 4,0m open end</i>	 8pol. Stiftgehäuse/ 8pol. male
50 140 724 24V 	1	Vorkonfektioniertes LED Überwachungs-Kit PRO-LCG überwacht die Blinklichtfunktion und kontrolliert die Brems-Schluss-Nebelschluß-Rückfahrlichtfunktion, Kabel 8x1mm ² , Eingangsseite 0,3m + 8pol Buchse, Ausgangsseite 0,3m + 8pol Stift <i>Pre-assembled LED Control Kit PRO-LCG monitors the dir. indicator function and is checking the funtions stop-tail-fog-reverse light, cable 8x1mm², cable input 0,3m + 8pol female, cable output 0,3m + 8pol male</i>	
50 140 712 12V	1		 8pol. Stiftgehäuse/ 8pol. male
50 051 837	1	Ausgangskabel 8 polig Buchsengehäuse mit 2 Leitungen 3,0m geradem Hotmelt Anschluss 7pol. AMP St. + Flachkabel 0,5m <i>Output cable 8 poles female with 2 wire 3,0m straight hotmelt cable connection 7-poles AMP con. + flat cable 0,5m</i>	 8pol. Buchsengehäuse/ 8pol. female
50 051 897	1	Ausgangskabel 8 polig Buchsengehäuse mit 2 Leitungen 3,0m 90° Kabelanschluss 7pol. AMP St. + Flachkabel 0,5m <i>Output cable 8 poles female with 2 wire 3,0m 90°-cable connection 7-poles AMP con. + flat cable 0,5m</i>	
50 051 815	1	Ausgangskabel 8 polig Buchsengehäuse mit 2 Leitungen 1,5m geradem Hotmelt Anschluss mit 5pol. Bajonett + Flachkabel 0,5m <i>Output cable 8 poles female with 1,5m with straight hotmelt cable connection 5-poles bayonet + flat cable 0,5m</i>	 7pol. AMP gerade / 90° 7pol. AMP straight / 90° 5pol. Bajonett/ 5pol. bayonet

Weitere Längen auf Anfrage

Further Length on request

LED Kontrollgerät

LED Control Gear

Typ: PRO-LCG Double 7-pol. AMP St.

Artikel-Nr. Reference-No.	VE QTY	Beschreibung Description	LED Kontrollgeräte - Kabel mit Stecker LED Control Gears - cable with connector
50 042 408	1	Eingangskabel 8 polig Stiftgehäuse mit 4,0m open end <i>Input cable 8 poles male connector with 4,0m open end</i>	
50 140 724 24V 	1	Vorkonfektioniertes zentral LED Kontrollgerät PRO-LCG überwacht die Blinklichtfunktion und kontrolliert die Brems-Schluss-Nebelschluss-Rückfahrlichtfunktion Eingang: 8-polig Buchsengehäuse Ausgang: 8-polig Stiftgehäuse ADR-geprüft, 24V Version ECE R10 geprüft Abmessungen PRO-LCG: L 175 x B 80 x H 22mm <i>Pre-assembled Central LED Control Gear PRO-LCG monitors the dir. indicator function and is checking the funtions stop-tail-fog-reverse light,</i> <i>Input: 8-poles connector female Output: 8-poles connector male ADR approved, 24V version ECE R10 approved</i>	
50 140 712 12V	1	Sizes PRO-LCG: L 175 x W 80 x H 22mm	
50 051 847	1	Ausgangskabel 8 polig Buchsengehäuse mit 2 Leitungen 3,0m geradem Hotmelt Anschluss 4 x 7pol AMP DIN 82585 + 2 x Flachkabel 0,5m <i>Output cable 8 poles female with 2 wire 3,0m straight hotmelt cable connection 4 x 7poles AMP DIN 82585 + 2 x flat cable 0,5m</i>	

Weitere Längen auf Anfrage

Further Length on request

LED Kontrollgerät

LED Control Gear

Typ: **PRO-LCG Double 5-pol. Bajonett St.**



Artikel-Nr. Reference-No.	VE QTY	Beschreibung Description	LED Kontrollgeräte - Kabel mit Stecker LED Control Gears - cable with connector
50 042 408	1	Eingangskabel 8 polig Stiftgehäuse mit 4,0m open end <i>Input cable 8 poles male connector with 4,0m open end</i>	
50 140 712 12V	1	Vorkonfektioniertes zentral LED Kontrollgerät PRO-LCG überwacht die Blinklichtfunktion und kontrolliert die Brems-Schluss-Nebelschluss-Rückfahrlichtfunktion Eingang: 8-polig Buchsengehäuse Ausgang: 8-polig Stiftgehäuse ADR-geprüft, 24V Version ECE R10 geprüft Abmessungen PRO-LCG: L 175 x B 80 x H 22mm <i>Pre-assembled Central LED Control Gear PRO-LCG monitors the dir. indicator function and is checking the funtions stop-tail-fog-reverse light,</i> <i>Input: 8-poles connector female Output: 8-poles connector male ADR approved, 24V version ECE R10 approved</i> <i>Sizes PRO-LCG: L 175 x W 80 x H 22mm</i>	
50 051 845	1	Ausgangskabel 8 polig Buchsengehäuse mit 2 Leitungen 3,0m geradem Hotmelt Anschluss 4 x 5pol. Bajonettstecker + 2 x Flachkabel 0,5m <i>Output cable 8 poles female with 2 wire 3,0m straight hotmelt cable connection 4 x 5-poles bayonet connector + 2 x flat cable 0,5m</i>	

Weitere Längen auf Anfrage

Further Length on request

LED Kontrollgerät

LED Control Gear

Typ: **PRO-LCG Triple 7-pol. AMP St.**



Artikel-Nr. Reference-No.	VE QTY	Beschreibung Description	LED Kontrollgeräte - Kabel mit Stecker LED Control Gears - cable with connector
50 042 408	1	<p>Eingangskabel 8 polig Stiftgehäuse mit 4,0m open end</p> <p><i>Input cable 8 poles male connector with 4,0m open end</i></p>	
<p>50 140 724 24V</p>	1	<p>Vorkonfektioniertes zentral LED Kontrollgerät PRO-LCG überwacht die Blinklichtfunktion und kontrolliert die Brems-Schluss-Nebelschluss-Rückfahrlichtfunktion</p> <p>Eingang: 8-polig Buchsengehäuse Ausgang: 8-polig Stiftgehäuse ADR-geprüft, 24V Version ECE R10 geprüft</p> <p>Abmessungen PRO-LCG: L 175 x B 80 x H 22mm</p> <p><i>Pre-assembled Central LED Control Gear PRO-LCG monitors the dir. indicator function and is checking the funtions stop-tail-fog-reverse light,</i></p> <p><i>Input: 8-poles connector female Output: 8-poles connector male ADR approved, 24V version ECE R10 approved</i></p>	
50 140 712 12V	1	<p>Sizes PRO-LCG: L 175 x W 80 x H 22mm</p>	
50 051 867	1	<p>Ausgangskabel 8 polig Buchsengehäuse mit 2 Leitungen 3,0m geradem Hotmelt Anschluss 6 x 7pol AMP DIN 82585 + 2 x Flachkabel 0,5m</p> <p><i>Output cable 8 poles female with 2 wire 3,0m straight hotmelt cable connection 6 x 7poles AMP DIN 82585 + 2 x flat cable 0,5m</i></p>	

Weitere Längen auf Anfrage

Further Length on request

LED Kontrollgerät

LED Control Gear

Typ: **PRO-LCG Triple 5-pol. Bajonett St.**



Artikel-Nr. Reference-No.	VE QTY	Beschreibung Description	LED Kontrollgeräte - Kabel mit Stecker LED Control Gears - cable with connector
50 042 408	1	Eingangskabel 8 polig Stiftgehäuse mit 4,0m open end <i>Input cable 8 poles male connector with 4,0m open end</i>	
50 140 712 12V	1	Vorkonfektioniertes zentral LED Kontrollgerät PRO-LCG überwacht die Blinklichtfunktion und kontrolliert die Brems-Schluss-Nebelschluss-Rückfahrlichtfunktion Eingang: 8-polig Buchsengehäuse Ausgang: 8-polig Stiftgehäuse ADR-geprüft, 24V Version ECE R10 geprüft Abmessungen PRO-LCG: L 175 x B 80 x H 22mm <i>Pre-assembled Central LED Control Gear PRO-LCG monitors the dir. indicator function and is checking the funtions stop-tail-fog-reverse light,</i> <i>Input: 8-poles connector female Output: 8-poles connector male ADR approved, 24V version ECE R10 approved</i> <i>Sizes PRO-LCG: L 175 x W 80 x H 22mm</i>	
50 051 865	1	Ausgangskabel 8 polig Buchsengehäuse mit 2 Leitungen 3,0m geradem Hotmelt Anschluss 6 x 5pol. Bajonettstecker + 2 x Flachkabel 0,5m <i>Output cable 8 poles female with 2 wire 3,0m straight hotmelt cable connection 6 x 5-poles bayonet connector + 2 x flat cable 0,5m</i>	

Weitere Längen auf Anfrage

Further Length on request

LED Kontrollgerät

LED Control Gear

 Typ: **PRO-LCG 15 pin**

Artikel-Nr. <i>Reference-No.</i>	VE <i>QTY</i>	Beschreibung <i>Description</i>	LED Kontrollgeräte - Kabel mit Stecker <i>LED Control Gears - cable with connector</i>
50 173 000 24V 	1	<p>Vorkonfektioniertes zentral LED Kontrollgerät PRO-LCG überwacht die Blinklichtfunktion und kontrolliert die Brems-Schluss-Nebelschluss-Rückfahrlichtfunktion</p> <p>Eingang: 15pol ISO 12098 Stift Ausgang: 2 x 7pol AMP DIN 82585 2 x Flachkabel 2 x 0,75²</p> <p>ADR-geprüft, ECE R10 geprüft</p> <p>Abmessungen LCG: L 175 x B 80 x H 22mm</p> <p><i>Pre-assembled Central LED Control Gear PRO-LCG monitors the dir. indicator function and is checking the funtions stop-tail-fog-reverse light,</i></p> <p><i>Input: 15poles ISO 12098 male Output: 2 x 7poles AMP DIN 82585 2 x flat cable 2 x 0,75²</i></p> <p>ADR approved, ECE R10 approved</p> <p>Sizes LCG: L 175 x W 80 x H 22mm</p> <p>Das PRO-LCG dient als Kontroll- und Vorschaltgerät vor LED Fahrzeugleuchten in 12V oder 24V Bordnetzen. Es ermöglicht dem im Zugfahrzeug vorhandenen Kontrollsystem zu erkennen und anzuzeigen, ob eine Blinkerfunktion ausgefallen ist. Weiterhin verhindert es unkorrekte Ausfallmeldungen bei anderen Leuchtenfunktionen, die durch die geringe Stromaufnahme der LED Leuchten bedingt sind.</p> <p><i>The PRO-LCG is used as a control and ballast unit for LED vehicle lights in 12V or 24V onboard electrical systems. It enables the control system already installed in the towing vehicle to detect and display wether a direction indicator function has failed. Furthermore, it reverts incorrect failure signals for other light functions that are conditional on the lower power consumption of the LED lights.</i></p>	

Weitere Längen auf Anfrage

Further Length on request

LED Kontrollgerät

LED Control Gear

Typ: **PRO-LCG 15 pin**



Artikel-Nr. Reference-No.	VE QTY	Beschreibung Description	LED Kontrollgeräte - Kabel mit Stecker LED Control Gears - cable with connector
<p>50 173 100 24V </p>	<p>1</p>	<p>Vorkonfektioniertes zentral LED Kontrollgerät PRO-LCG überwacht die Blinklichtfunktion und kontrolliert die Brems-Schluss-Nebelschluss-Rückfahrlichtfunktion</p> <p>Eingang: 15pol ISO 12098 Buchse Ausgang: 2 x 7pol AMP DIN 82585 2 x Flachkabel 2 x 0,75²</p> <p>ADR-geprüft, ECE R10 geprüft</p> <p>Abmessungen: L 175 x B 80 x H 22mm</p> <p><i>Pre-assembled Central LED Control Gear PRO-LCG monitors the dir. indicator function and is checking the funtions stop-tail-fog-reverse light,</i></p> <p><i>Input: 15poles ISO 12098 female Output: 2 x 7poles AMP DIN 82585 2 x flat cable 2 x 0,75²</i></p> <p>ADR approved, ECE R10 approved</p> <p>Sizes: L 175 x W 80 x H 22mm</p> <p>Das PRO-LCG dient als Kontroll-und Vorschaltgerät vor LED Fahrzeugleuchten in 12V oder 24V Bordnetzen. Es ermöglicht dem im Zugfahrzeug vorhandenen Kontrollsystem zu erkennen und anzuzeigen, ob eine Blinkerfunktion ausgefallen ist. Weiterhin verhindert es unkorrekte Ausfallmeldungen bei anderen Leuchtenfunktionen, die durch die geringe Stromaufnahme der LED Leuchten bedingt sind.</p> <p><i>The PRO-LCG is used as a control and ballast unit for LED vehicle lights in 12V or 24V onboard electrical systems. It enables the control system already installed in the towing vehicle to detect and display wether a direction indicator function has failed. Furthermore, it reverts incorrect failure signals for other light functions that are conditional on the lower power consumption of the LED lights.</i></p>	

Weitere Längen auf Anfrage

Further Length on request

LED Kontrollgerät

LED Control Gear

Typ: PRO-CONTROL

Artikel-Nr. <i>Reference-No.</i>	VE <i>QTY</i>	Beschreibung <i>Description</i>	LED Kontrollgeräte <i>LED Control Gears</i>	
50 141 500 12/24V	1	<p>LED Kontrollgerät PRO-CONTROL dient zur Überwachung der Blinklichtfunktion, Kabel 1m - 3 x 0,75mm², Blinkerausfallkontrolle,</p> <p>1 LCG pro LED Leuchte</p> <p>Besonderheit: Kontrollgerät für 12 Volt und 24 Volt verwendbar</p> <p><i>LED Control Gear PRO-CONTROL monitors the direction indicator function, cable 1m - 3 x 0,75mm²,</i></p> <p><i>1 LCG per LED lamp</i></p> <p><i>Highlight:</i> <i>Controll Gear useable for 12 Volt and 24 Volt</i></p>		 <p>LED Kontrollgerät PRO-CONTROL dient zur Anpassung der elektrischen Eigenschaften der LED Leuchten an die Anforderungen der Zugmaschine, inklusive Kabel und Einbauanleitung</p> <p><i>LED Control Gear PRO-CONTROL is needed for the adjustment of the electrical characteristics of the LED lights to the requirements of the tractors, including cable and fitting instruction</i></p>
50 141 212 12V	1	<p>Vorverkabeltes LED Überwachungs-Kit PRO-CONTROL dient zur Überwachung der Blinklichtfunktion, Blinkerausfallkontrolle, Kabel 0,3m</p> <p>Eingang: 5 pol. Bajonett-Stift Ausgang: 5-pol. Bajonett-Buchse</p> <p>1 LCG pro LED Leuchte, ECE R10 geprüft</p> <p><i>Pre-assembled LED Control Kit (LCG) PRO-CONTROL monitors the direction indicator function, cable 0,3m</i></p> <p><i>Input: 5-poles bayonet con. male</i> <i>Output: 5-poles bayonet con. female</i></p> <p><i>1 LCG per LED lamp, ECE R10 approved</i></p>		 <p>Bajonettstecker 5-pol. Stiftgehäuse/ Connector 5-poles male</p> <p>Bajonettstecker 5-pol. Buchsengehäuse/ Connector 5-poles female</p>

LED Kontrollgerät

LED Control Gear



Artikel-Nr. Reference-No.	VE QTY	Beschreibung Description	LED Kontrollgeräte LED Control Gears	
50 141 024 24V	1	LED Kontrollgerät PRO-CONTROL dient zur Überwachung der Blinklichtfunktion, Kabel 1m - 3 x 0,75mm ² , Blinkerausfallkontrolle, 1 LCG pro LED Leuchte 12V Version ECE R10 geprüft		
50 141 012 12V 	1	LED Kontrollgerät PRO-CONTROL monitors the direction indicator function, cable 1m - 3 x 0,75mm ² , 1 LCG per LED lamp 12V Version ECE R10 approved		<p>LED Kontrollgerät PRO-CONTROL dient zur Anpassung der elektrischen Eigenschaften der LED Leuchten an die Anforderungen der Zugmaschine, inklusive Kabel und Einbauanleitung</p> <p><i>LED Control Gear PRO-CONTROL is needed for the adjustment of the electrical characteristics of the LED lights to the requirements of the tractors, including cable and fitting instruction</i></p>
50 139 024 24V	1	LED Kontrollgerät PRO-LOAD dient zur Kontrolle der 21W Funktionen, Brems-Blink-Nebel-Rückfahrlicht, Lastwiderstand, Kabel 1,0m, 1 LCG je Funktion und LED Leuchte		
50 139 012 12V	1	LED Kontrollgerät PRO-LOAD is checking the 21W functions like stop-dir.indicator-fog-reversing light, cable 1,0m, 1 LCG per function and LED lamp		<p>Für den Einsatz bei Fehlermeldungen in Fahrzeugen mit Bordcomputer die im Zusammenhang mit der Umrüstung von Glühlampen auf LED -Module entstehen können. Mit dem Einbau wird die Fehlererkennung im Bordcomputer ausgeschaltet.</p> <p><i>For the application in vehicles with onboard computer. If changing from bulbs to LED modules, the LCG switch of the failure message.</i></p>
50 125 000 24V	1	LED Kontrollgerät dient zur Kontrolle der Schlusslichtfunktion, Lastwiderstand, Kabel 1,0m 1 LCG pro LED Leuchte		
50 125 012 12V	1	LED Kontrollgerät is checking the tail light function, cable 1,0m, 1 LCG per LED lamp		<p>Für den Einsatz bei Fehlermeldungen in Fahrzeugen mit Bordcomputer die im Zusammenhang mit der Umrüstung von Glühlampen auf LED -Module entstehen können. Mit dem Einbau wird die Fehlererkennung im Bordcomputer ausgeschaltet.</p> <p><i>For the application in vehicles with onboard computer. If changing from bulbs to LED modules, the LCG switch of the failure message.</i></p>

Blink-Modul für Seitenmarkierungsleuchten

Blink-Unit for Sidemarker Lamps



Artikel-Nr. Reference-No.	VE QTY	Beschreibung Description	Blink-Modul Blink-Unit
50 142 000	1	<p>Blinkersteuerung für Seitenmarkierungsleuchten PRO-BLINK, Typ Universal, Ein-/Ausgangskabel open end, 10-30V, gem. ECE R48, Rev.6</p> <p><i>Direction Indicator Control System for Sidemarker Lamps, PRO-BLINK, type universal, Input/Output-Cable open end, 10-30V, according to ECE R48 rev.6</i></p> <p>Eingangskabel 2m, 3x0,75², Ausgangskabel 1m, 2x1² Input cable 2m, 3x0,75², Output cable 1m, 2x1²</p>	
50 142 100	1	<p>Blinkersteuerung für Seitenmarkierungsleuchten PRO-BLINK, Typ Flachkabel, Eingangskabel open end, Ausgang Flachkabel, 10-30V, gem. ECE R48, Rev.6</p> <p><i>Direction Indicator Control System for Sidemarker Lamps, PRO-BLINK, type DC flatcable, Input-Cable open end, Output-Cable flatcable, 10-30V, according to ECE R48 rev.6</i></p> <p>Eingangskabel 2m, 3x0,75², Ausgangskabel 1m Flach- kabel 2x0,75² Input cable 2m, 3x0,75², Output cable 1m DC-cable, 2x0,75²</p>	
50 142 200	1	<p>Blinkersteuerung für Seitenmarkierungsleuchten PRO-BLINK, Typ AMP, Eingangskabel 7-polig AMP-Stecker, Ausgang 2-polig AMP-Stecker, 10-30V, gem. ECE R48, Rev.6</p> <p><i>Direction Indicator Control System for Sidemarker Lamps, PRO-BLINK, type AMP, Input-Cable 7-pole AMP-connector, Output-Cable 2-pole AMP-connector, 10-30V, according to ECE R48 rev.6</i></p> <p>Eingangskabel 2m, 3x0,75², einge- schleift in Verbindungskabel 6x1² mit 7-pol AMP Stecker/Buchse, Ausgangskabel 1m, 2x1² mit 2-pol. AMP-Superseal-Buchse PRO-BLINK, Input cable 2m, 3x0,75², looped into connection cable 6x1² with 7-pol AMP connectors m/f, Output cable 1m, 2x1² with 2-pol AMP Superseal connector (f)</p>	

Verteilerkabel/Adapterkabel

Distribution Cable/Adapte Cable

Artikel-Nr. Reference-No.	VE QTY	Beschreibung Description	Verteilerkabel Distribution Cable
50 051 000	1	Verteilerkabel Brems/Blink/Schlusslicht - Nebelschluss/Rückfahrlicht 7-polig Stecker mit 0,5m Kabel Anschluß von 2 x Brems/Blink/Schlusslicht auch möglich <i>Distribution cable</i> <i>tail/dir. indicator/stop -</i> <i>fog/reverse function</i> <i>7-pole connector with 0,5m cable</i> <i>Connection of</i> <i>2 x tail/dir. indicator/stop lamps</i> <i>also possible</i>	<p>AMP-Stecker 7-pol. männlich/ AMP-Connector 7-poles male</p> <p>500mm</p> <p>AMP-Stecker 7-pol. weiblich/ AMP-Connector 7-poles female</p> <p>500mm</p> <p>AMP-Stecker 7-pol. weiblich/ AMP-Connector 7-poles female</p>
50 042 200	1	Verlängerungskabel 1,5m, AMP Stecker Stift 7-polig hotmelt + Buchse 7-polig hotmelt <i>Extension cable 1,5m,</i> <i>one side with AMP 7-pole con. male,</i> <i>second side AMP 7-pole con. female</i>	<p>AMP-Stecker 7-pol. männlich/ AMP-Connector 7-poles male</p> <p>AMP-Stecker 7-pol. weiblich/ AMP-Connector 7-poles female</p>
50 043 000	1	Verlängerungskabel 1,5m, Bajonettst. Stift 5-polig hotmelt + Buchse 5-polig hotmelt <i>Extension cable 1,5m,</i> <i>one side 5-pole bajonett con. male,</i> <i>second side 5-pole con. female</i>	<p>Bajonett-Stecker 5-pol. männlich/ Bayonet-Connector 5-poles male</p> <p>Bajonett-Stecker 5-pol. weiblich/ Bayonet-Connector 5-poles female</p>
50 005 000	1	Adapterkabel zur Ansteuerung einer zusätzlichen 3. Bremsleuchte, Kabel 0,25/0,25m <i>Adapter cable for using an</i> <i>additional 3rd Stop lamp,</i> <i>cable 0,25/0,25m</i>	<p>250mm 2 x 0,75mm² Flachkabel/flatcable</p> <p>Bajonettstecker 5-pol. männlich/ Bayonet-Connector 5-poles male</p> <p>250mm 4 x 0,75mm²</p> <p>Bajonettstecker 5-pol. weiblich/ Bayonet-Connector 5-poles female</p>
50 006 000	1	Adapterkabel zur Ansteuerung einer zusätzlichen Rückfahrleuchte, Kabel 0,4/0,6m <i>Adapter cable for using an</i> <i>additional reversing lamp,</i> <i>cable 0,4/0,6m</i>	<p>600mm 2 x 0,75mm² Flachkabel/flatcable</p> <p>Bajonettstecker 5-pol. männlich/ Bayonet-Connector 5-poles male</p> <p>400mm 4 x 0,75mm²</p> <p>Bajonettstecker 5-pol. weiblich/ Bayonet-Connector 5-poles female</p>

Kabel Kit

Cable Kit

Typ: **PRO-WIRE II 13/7**

Artikel-Nr. Reference-No.	VE QTY	Beschreibung Description	Kabel Kits Cable Kits
50 045 100	1	Kabel Kit PRO-WIRE II L1=8,5m mit Stecker 13-polig und Anschluss 7-polig, zusätzlich 2 Flachleitungen L2 & L3=0,1m <i>Cable Kit PRO-WIRE II L1=8,5m with connector 13-poles, 7-pole connector and 2 flatcables L2 & L3=0,1m</i>	
50 045 200	1	Kabel Kit PRO-WIRE II L1=10m mit Stecker 13-polig und Anschluss 7-polig, zusätzlich 2 Flachleitungen L2 & L3=0,1m <i>Cable Kit PRO-WIRE II L1=10m with connector 13-poles, 7-pole connector and 2 flatcables L2 & L3=0,1m</i>	
50 045 300	1	Kabel Kit PRO-WIRE II L1=12m mit Stecker 13-polig und Anschluss 7-polig, zusätzlich 2 Flachleitungen L2 & L3=0,1m <i>Cable Kit PRO-WIRE II L1=12m with connector 13-poles, 7-pole connector and 2 flatcables L2 & L3=0,1m</i>	

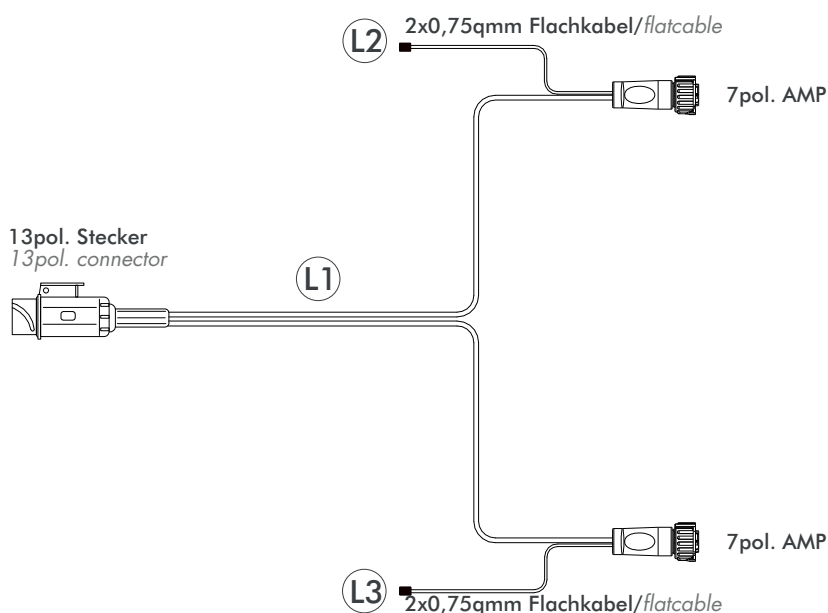

Sollten Sie den gewünschten Kabelsatz nicht in unserem Standardprogramm finden, bieten wir Ihnen auch gern andere Längen auf Anfrage an. Nutzen Sie dazu unsere Anfragezeichnung und nennen uns die benötigte Länge L1, L2 und L3.

On request, we are able to offer you a cable kit with different length if you could not find the version you are looking for. Therefore please use the above drawing and tell us the length you need, L1, L2 and L3.

Kabel Kit

Cable Kit

Typ: **PRO-WIRE II 13/5**

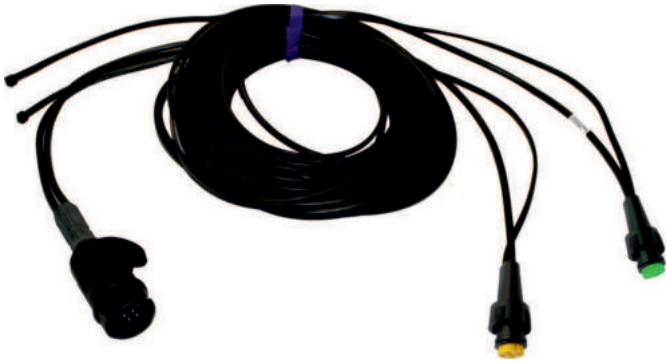
Artikel-Nr. Reference-No.	VE QTY	Beschreibung Description	Kabel Kits Cable Kits
50 049 400	1	Kabel Kit PRO-WIRE II L1=5m mit Stecker 13-polig und Anschluss 5-polig, zusätzlich 2 Flachleitungen L2 & L3=3m <i>Cable Kit PRO-WIRE II L1=5m with connector 13-poles, 5-pole connector and 2 flatcables L2 & L3=3m</i>	
58 204 001	1	Kabel Kit PRO-WIRE II L1=8m mit Stecker 13-polig und Anschluss 5-polig, zusätzlich 2 Flachleitungen L2 & L3=6m <i>Cable Kit PRO-WIRE II L1=8m with connector 13-poles, 5-pole connector and 2 flatcables L2 & L3=6m</i>	
58 204 000	1	Kabel Kit PRO-WIRE II L1=10m mit Stecker 13-polig und Anschluss 5-polig, zusätzlich 2 Flachleitungen L2 & L3=8m <i>Cable Kit PRO-WIRE II L1=10m with connector 13-poles, 5-pole connector and 2 flatcables L2 & L3=8m</i>	

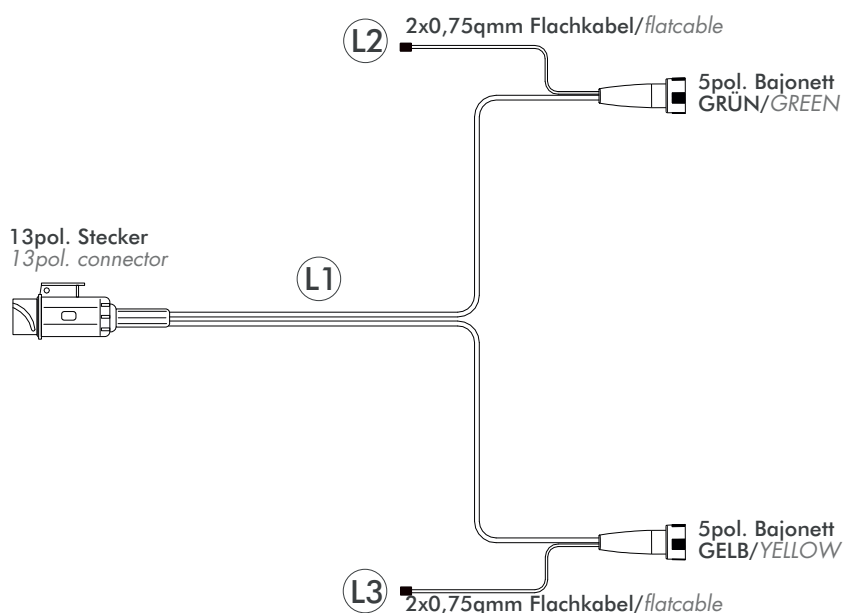

Sollten Sie den gewünschten Kabelsatz nicht in unserem Standardprogramm finden, bieten wir Ihnen auch gern andere Längen auf Anfrage an. Nutzen Sie dazu unsere Anfragezeichnung und nennen uns die benötigte Länge L1, L2 und L3.

On request, we are able to offer you a cable kit with different length if you could not find the version you are looking for. Therefore please use the above drawing and tell us the length you need, L1, L2 and L3.

Kabel Kit

Cable Kit

Typ: **PRO-WIRE II 7/5**

Artikel-Nr. Reference-No.	VE QTY	Beschreibung Description	Kabel Kits Cable Kits
58 109 808	1	Kabel Kit PRO-WIRE II L1=5m mit Stecker 7-polig DIN/ISO 1724 und Anschluss 5-polig, zusätzlich 2 Flachleitungen L2 & L3=0,5m <i>Cable Kit PRO-WIRE II L1=5m with connector 7-poles DIN/ISO 1724, 5-pole connector and 2 flatcables L2 & L3=0,5m</i>	
58 109 807	1	Kabel Kit PRO-WIRE II L1=6m mit Stecker 7-polig DIN/ISO 1724 und Anschluss 5-polig, zusätzlich 2 Flachleitungen L2 & L3=0,5m <i>Cable Kit PRO-WIRE II L1=6m with connector 7-poles DIN/ISO 1724, 5-pole connector and 2 flatcables L2 & L3=0,5m</i>	
58 109 820	1	Kabel Kit PRO-WIRE II L1=7m mit Stecker 7-polig DIN/ISO 1724 und Anschluss 5-polig, zusätzlich 2 Flachleitungen L2 & L3=0,5m <i>Cable Kit PRO-WIRE II L1=7m with connector 7-poles DIN/ISO 1724, 5-pole connector and 2 flatcables L2 & L3=0,5m</i>	

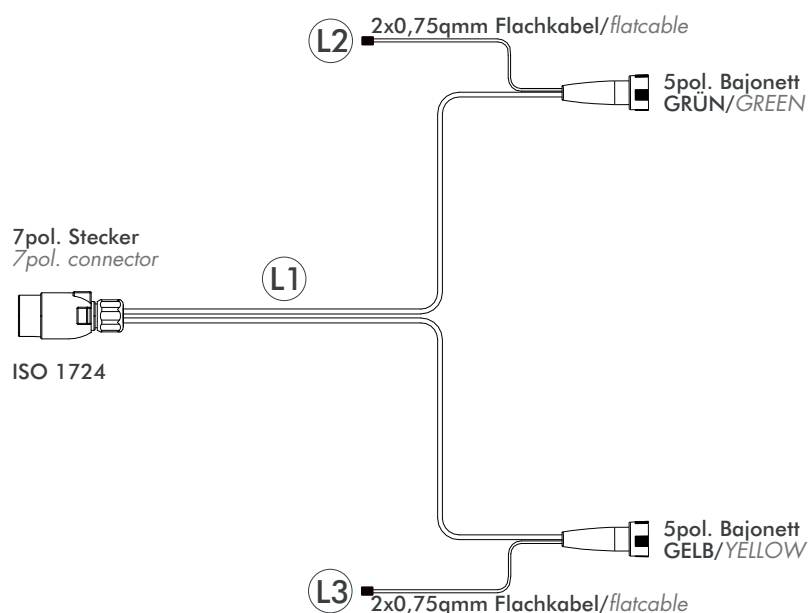

Sollten Sie den gewünschten Kabelsatz nicht in unserem Standardprogramm finden, bieten wir Ihnen auch gern andere Längen auf Anfrage an. Nutzen Sie dazu unsere Anfragezeichnung und nennen uns die benötigte Länge L1, L2 und L3.

On request, we are able to offer you a cable kit with different length if you could not find the version you are looking for. Therefore please use the above drawing and tell us the length you need, L1, L2 and L3.

Kabel Kit

Cable Kit

Typ: **PRO-WIRE I 13/5**

Artikel-Nr. Reference-No.	VE QTY	Beschreibung Description	Kabel Kits Cable Kits
50 048 100	1	Kabel Kit PRO-WIRE I L1=4m mit Stecker 13-polig und 2 Leitungen Stecker 5-polig <i>Cable Kit PRO-WIRE I L1=4m with connector 13-poles and 2 cables with 5-pole connector</i>	
50 049 100	1	Kabel Kit PRO-WIRE I L1=5m mit Stecker 13-polig und 2 Leitungen Stecker 5-polig <i>Cable Kit PRO-WIRE I L1=5m with connector 13-poles and 2 cables with 5-pole connector</i>	
50 050 100	1	Kabel Kit PRO-WIRE I L1=7m mit Stecker 13-polig und 2 Leitungen Stecker 5-polig <i>Cable Kit PRO-WIRE I L1=7m with connector 13-poles and 2 cables with 5-pole connector</i>	

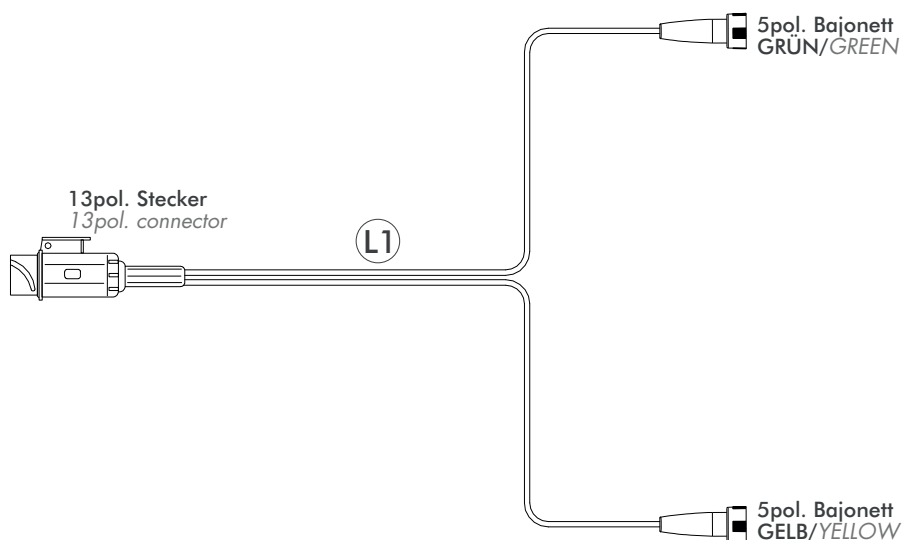

Sollten Sie den gewünschten Kabelsatz nicht in unserem Standardprogramm finden, bieten wir Ihnen auch gern andere Längen auf Anfrage an. Nutzen Sie dazu unsere Anfragezeichnung und nennen uns die benötigte Länge L1.

On request, we are able to offer you a cable kit with different length if you could not find the version you are looking for. Therefore please use the above drawing and tell us the length you need, L1.

Kabel Kit

Cable Kit

Typ: **PRO-WIRE I 7/5**

Artikel-Nr. Reference-No.	VE QTY	Beschreibung Description	Kabel Kits Cable Kits
50 048 000	1	Kabel Kit PRO-WIRE I L1=4m mit Stecker 7-polig DIN/ISO 1724 und 2 Leitungen Stecker 5-polig <i>Cable Kit PRO-WIRE I L1=4m with connector 7-poles DIN/ISO 1724 and 2 cables with 5-pole connector</i>	
50 049 000	1	Kabel Kit PRO-WIRE I L1=5m mit Stecker 7-polig DIN/ISO 1724 und 2 Leitungen Stecker 5-polig <i>Cable Kit PRO-WIRE I L1=5m with connector 7-poles DIN/ISO 1724 and 2 cables with 5-pole connector</i>	
50 050 000	1	Kabel Kit PRO-WIRE I L1=7m mit Stecker 7-polig DIN/ISO 1724 und 2 Leitungen Stecker 5-polig <i>Cable Kit PRO-WIRE I L1=7m with connector 7-poles DIN/ISO 1724 and 2 cables with 5-pole connector</i>	

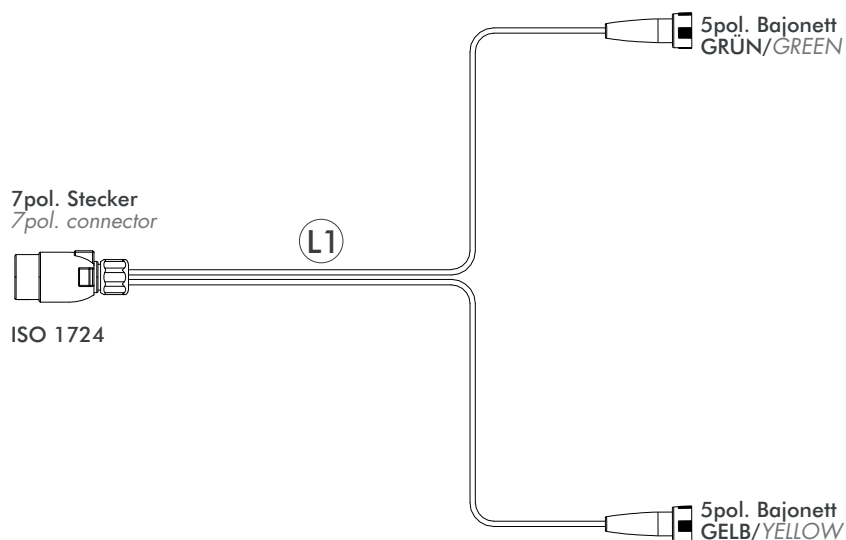





Sollten Sie den gewünschten Kabelsatz nicht in unserem Standardprogramm finden, bieten wir Ihnen auch gern andere Längen auf Anfrage an. Nutzen Sie dazu unsere Anfragezeichnung und nennen uns die benötigte Länge L1.

On request, we are able to offer you a cable kit with different length if you could not find the version you are looking for. Therefore please use the above drawing and tell us the length you need, L1.

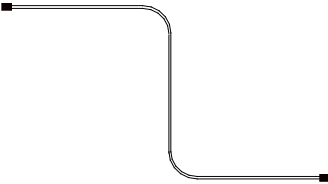
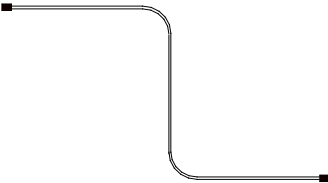
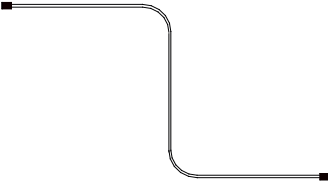
Flachkabel P2G

Flatcable P2G

Artikel-Nr. Reference-No.	VE QTY	Beschreibung Description	Flachkabel P2G Flatcable P2G	
50 007 200	1	Flachkabelverlängerung 2m 2x0,75mm ² <i>Flatcable extension 2m 2x0,75mm²</i>		Verlängerungskabel für Einzelfunktionsleuchten <i>extension for single function lamps</i>
50 007 300	1	Flachkabelverlängerung 3m 2x0,75mm ² <i>Flatcable extension 3m 2x0,75mm²</i>		
50 007 400	1	Flachkabelverlängerung 4m 2x0,75mm ² <i>Flatcable extension 4m 2x0,75mm²</i>		
50 007 500	1	Flachkabelverlängerung 5m 2x0,75mm ² <i>Flatcable extension 5m 2x0,75mm²</i>		Verlängerungskabel für Einzelfunktionsleuchten <i>extension for single function lamps</i>
50 007 600	1	Flachkabelverlängerung 6m 2x0,75mm ² <i>Flatcable extension 6m 2x0,75mm²</i>		
50 007 800	1	Flachkabelverlängerung 8m 2x0,75mm ² <i>Flatcable extension 8m 2x0,75mm²</i>		
50 007 110	1	Flachkabelverlängerung 10m 2x0,75mm ² <i>Flatcable extension 10m 2x0,75mm²</i>		Verlängerungskabel für Einzelfunktionsleuchten <i>extension for single function lamps</i>
50 007 112	1	Flachkabelverlängerung 12m 2x0,75mm ² <i>Flatcable extension 12m 2x0,75mm²</i>		
50 007 115	1	Flachkabelverlängerung 15m 2x0,75mm ² <i>Flatcable extension 15m 2x0,75mm²</i>		
50 002 000	1	Schrumpfhülsen für P2G Flachkabel wasserdichte Abschluss eines abgeschnittenen Kabels <i>Heatshrink-Endcaps for flatcable 2x0,75mm</i>		 50 001 000
50 001 000	10	P2G-Verbinder für die elektrische Verbindung von 2 P2G Flachkabel <i>P2G connector for flatcable 2x0,75</i>	50 002 000	
17 720 000	1	Flachkabel auf Rolle, 200m, 2 x 0,75mm <i>Flat-Cable on roll, 200m, 2 x 0,75mm</i>		

Anschlußstecker

Connectors

Typ: AMP SUPER SEAL / DEUTSCH DT

Artikel-Nr. Reference-No.	VE QTY	Beschreibung Description	Anschlußstecker Connectors	
50 079 000	1	Steckverbinderset 2-polig, AMP SUPER SEAL Connector Set 2-poles, AMP SUPER SEAL		
50 079 900	1	T-Stück Steckverbinder 2-polig, AMP SUPER SEAL T-Connector 2-poles, AMP SUPER SEAL	50 079 000	50 079 900
50 079 100	1	Steckverbinder Stiftgehäuse 2-polig, AMP SUPER SEAL Connector 2-poles male, AMP SUPER SEAL		
50 079 200	1	Steckverbinder Buchsengehäuse 2-polig, AMP SUPER SEAL Connector 2-poles female, AMP SUPER SEAL	50 079 100	50 079 200
50 079 300	1	Steckverbinder Stiftgehäuse 3-polig, AMP SUPER SEAL Connector 3-poles male, AMP SUPER SEAL		
50 079 400	1	Steckverbinder Buchsengehäuse 3-polig, AMP SUPER SEAL Connector 3-poles female, AMP SUPER SEAL	50 079 300	50 079 400
50 079 500	1	Steckverbinder Stiftgehäuse 4-polig, AMP SUPER SEAL Connector 4-poles male, AMP SUPER SEAL		
50 079 600	1	Steckverbinder Buchsengehäuse 4-polig, AMP SUPER SEAL Connector 4-poles female, AMP SUPER SEAL	50 079 500	50 079 600
50 003 100	1	Steckverbinder Stiftgehäuse 2-polig, DEUTSCH DT Connector 2-poles male, DEUTSCH DT		
50 003 200	1	Steckverbinder Buchsengehäuse 2-polig, DEUTSCH DT Connector 2-poles female, DEUTSCH DT	50 003 100	50 003 200
50 003 300	1	Steckverbinder Stiftgehäuse 3-polig, DEUTSCH DT Connector 3-poles male, DEUTSCH DT		
50 003 500	1	Steckverbinder Buchsengehäuse 3-polig, DEUTSCH DT Connector 3-poles female, DEUTSCH DT	50 003 300	50 003 500
50 003 400	1	Steckverbinder Stiftgehäuse 4-polig, DEUTSCH DT Connector 4-poles male, DEUTSCH DT		
50 003 600	1	Steckverbinder Buchsengehäuse 4-polig, DEUTSCH DT Connector 4-poles female, DEUTSCH DT	50 003 400	50 003 600

Anschlußstecker

Connectors







Typ: **UNIVERSAL / ASPÖCK**

Artikel-Nr. Reference-No.	VE QTY	Beschreibung Description	Anschlußstecker Connectors	
50 059 100	1	Kompaktstecker 8-polig Stiftgehäuse <i>Connector 8-poles, male</i>		
50 059 200	1	Kompaktstecker 8-polig Buchsengehäuse <i>Connector 8-poles, female</i>		
50 059 100			50 059 100	50 059 200
50 068 100	1	Kompaktstecker 7-polig HDSCS Stiftgehäuse <i>Connector 7-poles, HDSCS male</i>		
50 068 200	1	Kompaktstecker 7-polig HDSCS Buchsengehäuse <i>Connector 7-poles, HDSCS female</i>		
50 068 100			50 068 100	50 068 200
50 068 000	1	Kompaktstecker 8-polig HDSCS Buchsengehäuse mit Schrumpfschlauch <i>Connector 8-poles, HDSCS female with heat shrink tube</i>		
50 068 000			50 068 000	
50 071 100	1	Kompaktstecker 7-polig AMP Buchsengehäuse <i>Connector 7-poles, AMP female</i>		
50 071 300	1	Kompaktstecker 7-polig AMP Stiftgehäuse <i>Connector 7-poles, AMP male</i>		
50 071 100			50 071 100	50 071 300
50 071 000	1	Kompaktstecker 8-polig, Anschluss 90° für u.a. M.A.N. <i>Connector 8-poles, 90° connector for M.A.N.</i>		
50 071 200	1	Kompaktstecker 8-polig, Anschluss gerade, für u.a. SCAN-Box <i>Connector 8-poles, straight connector for SCAN-Box</i>		
50 071 000			50 071 000	50 071 200
50 047 001	1	Kompaktstecker ASS1/ASS2 7-pol, Aspöck-Nr. 13-5626-941 <i>Connector ASS1/ASS2 7-poles, Aspöck-No. 13-5626-941</i>		
50 047 002	1	Kompaktstecker ASS1/ASS2 7-pol, Aspöck-Nr. 13-5626-951 <i>Connector ASS1/ASS2 7-poles, Aspöck-No. 13-5626-951</i>		
50 047 001			50 047 001	50 047 002
13 053 604	1	Kompaktstecker Stiftgehäuse 5-pol, Aspöck-Nr. 13-0536-044 <i>Connector 5-poles, male Aspöck-No. 13-0536-044</i>		
50 047 000	1	Kompaktstecker Buchsengehäuse 5-polig, Aspöck-Nr. 13-0546-004 <i>Connector 5-poles, female Aspöck-No. 13-0546-004</i>		
13 053 604			13 053 604	50 047 000

Anschlußstecker

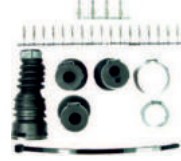
Connectors

Typ: **ASPÖCK**

Artikel-Nr. Reference-No.	VE QTY	Beschreibung Description	Anschlußstecker Connectors
50 047 003	1	Kompaktstecker ASS1 2-polig, Aspöck-Nr.13-5626-284 <i>Connector ASS1 2-poles, Aspöck-No. 13-5626-284</i>	
13 172 200	1	Reparaturkit ASS3 Buchsengehäuse 17-pol. Aspöck-Nr. 13-1722-001 <i>Repairkit ASS3, 17-poles, female, Aspöck-Nr. 13-1722-001</i>	
13 173 200	1	Reparaturkit ASS3 Stiftgehäuse 17-pol. Aspöck-Nr. 13-1732-001 <i>Repairkit ASS3, 17-poles, male, Aspöck-Nr. 13-1732-001</i>	
13 562 633	1	Reparaturkit ASS1 Buchsengehäuse 2-pol. Aspöck-Nr. 13-5626-331 <i>Repairkit ASS1, 2-poles, female, Aspöck-Nr. 13-5626-331</i>	
15 562 403	1	Reparaturkit ASS2 Buchsengehäuse 2-pol. Aspöck-Nr. 15-5624-031 <i>Repairkit ASS2, 2-poles, female, Aspöck-Nr. 15-5624-031</i>	
15 028 102	1	Reparaturkit ASS2 Stiftgehäuse 2-pol. Aspöck-Nr. 15-0281-021 <i>Repairkit ASS2, 2-poles, male, Aspöck-Nr. 15-0281-021</i>	

Artikel-Nr. <i>Reference-No.</i>	Notizen <i>Notes</i>

Rückfahrwarner	Back Alarm Systems	10.0	- 10.1
Verteilerdosen	Junction Boxes	10.2	
Verbindungskabel	Cable System	10.3	- 10.4
Batterie Hauptschalter	Switch Isolator	10.5	
LED Module	LED Modul	10.5	
Schwingungsdämpfer	Shock Absorber	10.5	
PROPLAST Verkaufunterstützung	PROPLAST Sales Support	10.6	



Zubehör/Rückfahrwarner

Accessories/Back Alarm System

Artikel-Nr. Reference-No.	VE QTY	Beschreibung Description	Rückfahrwarner Back Alarm Systems	
50 090 000	1	<p>Rückfahrwarner 24V inkl. Kabel 1,20m, IP 68-gepr. Montagemöglichkeit: - Direktmontage am Schlußleuchtengehäuse - Montage am Fahrzeugrahmen</p> <p><i>Back Alarm System 24V incl. Cable 1,20m, IP 68 approved Fixation: - Direct at the rear lamp housing - At the chassis</i></p>	<p>98dBA</p> 	<p>Techn. Beschreibung <i>Specification</i></p> <ul style="list-style-type: none"> - 24V - Warnton 98db - pulsierender Ton - 2400 Hz - Zentralbefestigung für Bohrung 28mm 
50 090 100	1	<p>Rückfahrwarner 24V für den Einbau, ADR-geprüft Montagemöglichkeit: - Einbau im Schlußleuchtengehäuse</p> <p><i>Back Alarm System 24V recessed version, ADR approved Fixation: - Direct in the rear lamp housing</i></p>	<p>92dBA</p> 	<p>Techn. Beschreibung <i>Specification</i></p> <ul style="list-style-type: none"> - 24V - 70mA bei 24V - 92 dBA - 3300-500 Hz - 20 gr. - 25 x 25 x 25mm 

Zubehör/Rückfahrwarner

Accessories/Back Alarm System



Artikel-Nr. Reference-No.	VE QTY	Beschreibung Description	Rückfahrwarner Back Alarm Systems	
50 090 450	1	<p>Rückfahrwarner PRO-ALARM 97dBA 10/80V, Kabel 0,4m, Gehäuse wasserdicht verschlossen, IP67, ECE R10 geprüft</p> <p><i>Back Alarm System PRO-ALARM 97dBA 10/80V, cable 0,4m, waterproof casted, IP67, ECE R10 approved</i></p>	<p>97dBA</p> 	
50 090 750	1	<p>Rückfahrwarner PRO-ALARM 102dBA 10/80V, Kabel 0,4m, Gehäuse wasserdicht verschlossen, IP67, ECE R10 geprüft</p> <p><i>Back Alarm System PRO-ALARM 102dBA 10/80V, cable 0,4m, waterproof casted, IP67, ECE R10 approved</i></p>	<p>102dBA</p> 	
50 090 850	1	<p>Rückfahrwarner PRO-ALARM 92dBA 10/80V, Kabel 0,4m, Gehäuse wasserdicht verschlossen, IP67, ECE R10 geprüft</p> <p><i>Back Alarm System PRO-ALARM 92dBA 10/80V, cable 0,4m, waterproof casted, IP67, ECE R10 approved</i></p>	<p>92dBA</p> 	
50 090 950	1	<p>Rückfahrwarner PRO-ALARM white sound 97dBA 10/80V, Kabel 0,4m, Gehäuse wasserdicht verschlossen, IP67, ECE R10 geprüft</p> <p><i>Back Alarm System PRO-ALARM white sound 97dBA 10/80V, cable 0,4m, waterproof casted, IP67, ECE R10 approved</i></p>	<p>97dBA</p> 	

Zubehör/Verteilerdose

Accessories/Junction Box

Artikel-Nr. Reference-No.	VE QTY	Beschreibung Description	Verteilerdosen Junctions Boxes	
50 016 000	1	Verteilerdose 12-polig spritzwassergeschützt <i>Junction Box 12-poles, waterproofed</i>		
50 052 000	1	Verteilerdose, Außenanschlüsse mit PG-Verschraubungen, IP 54 geprüft <i>Junction Box with PG-Screws, IP 54 approved</i>		<p>Techn. Beschreibung <i>Specification</i></p> <ul style="list-style-type: none"> - Codierung Kontaktbrücken mit Nummern u. Farbe nach ISO12098 <i>Cables and numbers according to ISO 12098</i> - PG-Version mit farbigen Dichtstopfen für verschiedene Kabeldurchmesser <i>Cover with coloured boots for different cable diameter</i> - Kontaktbestückung innen und außen mit 6,3mm Flachstecker, AMP <i>All terminals are 6,3mm AMP faston</i> 
50 083 000	1	3-Fach Steckdosenverteiler 24V, verkabeltes Multifunktionsgehäuse mit: - Steckdose DIN/ISO 1185 - Steckdose DIN/ISO 3731 - Steckdose DIN/ISO 72570 15-polig <i>3-Socket Junction Box 24V, pre-assembled multifunction-housing with:</i> - Socket DIN/ISO 1185 - Socket DIN/ISO 3731 - Socket DIN/ISO 72570 15-poles		<p>Techn. Beschreibung <i>Specification</i></p> <ul style="list-style-type: none"> - Codierung Kontaktbrücken mit Nummern u. Farbe nach ISO12098 <i>Cables and numbers according to ISO 12098</i> - PG-Version mit farbigen Dichtstopfen für verschiedene Kabeldurchmesser <i>Cover with coloured boots for different cable diameter</i> - Kontaktbestückung innen und außen mit 6,3mm Flachstecker, AMP <i>All terminals are 6,3mm AMP faston</i> 

Zubehör/Fahrzeugleitung

Accessories/Cable

Artikel-Nr. Reference-No.	VE QTY	Beschreibung Description	Fahrzeugleitungen Cables
50 080 000	1	50m ADR-Rundleitung FLRYY 2 x 1,0mm für u.a. Seitenmarkierungs-, Begrenzungs- oder Umrissleucht. <i>ADR Cable round, FLRYY 2 x 1,0 for sidemarker-, position- or end outline marker lamps</i>	
50 081 200	1	200m PU-Flachkabel 2 x 1,5mm für u.a. Aspöck P&R Steckersystem <i>200m PU-Flat Cable 2 x 1,5mm for Aspöck P&R connector system</i>	
17 720 000	1	Flachkabel auf Rolle, 200m, 2 x 0,75mm <i>Flat-Cable on roll, 200m, 2 x 0,75mm</i>	
50 044 001	1	Spiralkabel, ausziehbar bis 7,5m <i>Spiral cable extends to 7,5m</i>	
50 105 005	1	Kabel 0,5m mit AMP Superseal Stecker <i>Cable 0,5m with AMP Superseal connector</i>	
50 105 015	1	Kabel 1,5m mit AMP Superseal Stecker <i>Cable 1,5m with AMP Superseal connector</i>	
50 138 000	1	Anschlusskabel für LED Begrenzungsleuchte SCANIA mit Kompaktstecker 2-polig, Kabel 0,3m <i>Cable for LED Position Lamp SCANIA with 2-pole connector, cable 0,3m</i>	





Zubehör/Verbindungskabel P&R

Accessories/Cable P&R

Artikel-Nr. Reference-No.	VE QTY	Beschreibung Description	Verbindungskabel P&R Cable P&R
68 500 005 Aspöck-Nr.: 68-5000-057	1	Anschlußleitung PUR 0,25m mit Aspöck P&R Stecker <i>Cable PUR 0,25m with Aspöck P&R connector</i>	
68 500 001 Aspöck-Nr.: 68-5000-017	1	Anschlußleitung PUR 0,5m mit Aspöck P&R Stecker <i>Cable PUR 0,5m with Aspöck P&R connector</i>	
68 500 002 Aspöck-Nr.: 68-5000-027	1	Anschlußleitung PUR 1,0m mit Aspöck P&R Stecker <i>Cable PUR 1,0m with Aspöck P&R connector</i>	
68 500 003 Aspöck-Nr.: 68-5000-037	1	Anschlußleitung PUR 1,5m mit Aspöck P&R Stecker <i>Cable PUR 1,5m with Aspöck P&R connector</i>	
68 500 004 Aspöck-Nr.: 68-5000-047	1	Anschlußleitung PUR 2,0m mit Aspöck P&R Stecker <i>Cable PUR 2,0m with Aspöck P&R connector</i>	
68 500 006 Aspöck-Nr.: 68-5000-067	1	Anschlußleitung PUR 3,5m mit Aspöck P&R Stecker <i>Cable PUR 3,5m with Aspöck P&R connector</i>	
15 597 101	10	Verschlusskappen für Aspöck P&R Stecker, grau <i>Caps for Aspöck P&R connector, grey</i>	

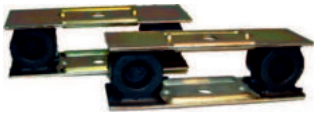

Zubehör

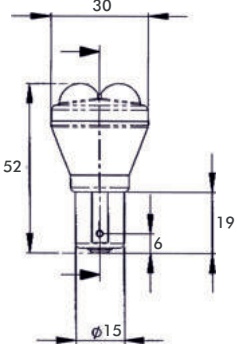
Accessories

Artikel-Nr. Reference-No.	VE QTY	Beschreibung Description	Schwingungsdämpfer/ <i>Reflex Reflectors</i> Batterie Hauptschalter/ <i>Switch Isolator</i> LED Modul/ <i>LED Module</i>	
50 015 000	1	<p>Schwingungsdämpfer-Kit für Schlußleuchten bestehend aus 2 flexiblen Dämpferelementen</p> <p><i>Shock Absorber-Kit for rear lamps, includes 2 flex. Fixation units</i></p>		
50 017 000	1	<p>Batterie Hauptschalter mit Schaltschlüssel, 2 Schraubanschlüsse</p> <p>Max. Belastung: 2500 A bei 24V (10 sek.)</p> <p><i>Switch, Isolator Heavy Duty</i></p> <p><i>Current rating, switching load: 2500 A on 24V (10 sec.)</i></p>		
50 018 000	1	<p>Batterie Hauptschalter mit Schaltschlüssel, 2 Schraubanschlüsse</p> <p>Max. Belastung: 1000 A bei 12V (10 sek.) 500 A bei 24V (10 sek.)</p> <p><i>Switch, Isolator Light Duty</i></p> <p><i>Current rating, switching load: 1000 A on 12V (10 sec.) 500 A on 24V (10 sec.)</i></p>		
40 199 002	10	<p>LED Modul "glowpoint" mit BA 15s Sockel. Ersetzt Glühlampen 5W BA 15s. Zugelassen für viele Proplast Leuchten. 24V - 28V Lebensdauer: über 10.000 Std.</p> <p><i>LED Module "glowpoint" with BA 15s base. Replacement for bulb 5W BA 15s. Approved for many Proplast Rear Lamps. 24V-28V Life expectancy: over 10.000H</i></p>		

PROPLAST Verkaufsunterstützung

PROPLAST Sales Support

Artikel-Nr. Reference-No.	VE QTY	Beschreibung Description	PROPLAST Leuchtenshop PROPLAST Lighting Shop
60 120 300	1	<p>PROPLAST Leuchtenshop PRO-TURN, Verkaufsständer drehbar, inkl. Leuchtenbestückung, alle LED-Leuchten in Funktion! Farbe lichtgrau Maße: Höhe 205cm, Breite 40x40cm</p> <p><i>Proplast Lighting Shop PRO-TURN, rotatable sales rack, fitted with different lamps, all LED lamps illuminated! Colour light grey Sizes: Height 205cm, Width 40x40cm</i></p>	 <p>PROPLAST Leuchtenshop / Lighting Shop Die aktive Verkaufsunterstützung in Ihren Verkaufsräumen! <i>The ideal sales support in your store!</i></p>
60 099 000	1	<p>LED Leuchtrahmen PRO-FRAME für Poster DIN A1 inkl. 220V Netzteil Farbe lichtgrau Maße: Höhe 889mm, Breite 623mm, Tiefe 13mm</p> <p><i>Illuminated picture frame PRO-FRAME for poster DIN A1 including 220V adapter Sizes: Height 889mm, Width 623mm, Depth 13mm</i></p>	
99 201 000	1	<p>Poster DIN A1 „Heckleuchten“ <i>Poster DIN A1 „Rear Comb. Lamps“</i></p>	
99 203 000	1	<p>Poster DIN A1 „Umriss/Positions/ Kennzeichenleuchten“ <i>Poster DIN A1 „End Outline Marker/ Position/Registration Plate Lamps“</i></p>	
99 204 000	1	<p>Poster DIN A1 „Scheinwerfer“ <i>Poster DIN A1 „Work Lamps“</i></p>	
99 205 000	1	<p>Poster DIN A1 „Kennleuchten“ <i>Poster DIN A1 „Beacons“</i></p>	
99 206 000	1	<p>Poster DIN A1 „Innenleuchten“ <i>Poster DIN A1 „Interior Lamps“</i></p>	

Herstellerverzeichnis

Manufacturer List

Fahrzeug <i>Manufacturer</i>	Rückleuchten <i>Rear Lamps</i>	Umriß-/Begrenzungsleuchten <i>Position Lamps</i>	Seitenmarkierungsleuchten <i>Sidemarker Lamps</i>
passend für	Katalogseiten / <i>Catalogue Pages</i>		
DAF	1.52; 1.54; 1.55; 1.72; 1.73		4.25
Fruehauf	1.72		
Iveco	1.56; 1.76; 1.77		4.25
Kögel	1.70; 1.97		4.13
Krone	1.71; 1.99; 1.100		
MAN	1.51; 1.52; 1.53		4.24
Mercedes	1.65; 1.66; 1.67; 1.68; 1.69; 1.71		4.23
Renault	1.52; 1.62; 1.72; 1.73		4.25
Scania	1.58; 1.59; 1.60		4.25
Schmitz	1.70; 1.71; 1.88; 1.89; 1.92; 1.100	3.15	4.18
Steyr	1.53		
Volvo	1.61; 1.62; 1.63; 1.64		4.25
VW	1.65		

Artikelnummernübersicht

Reference Numbers

Art.-Nr. Ref.No.	Seite Page	Art.-Nr. Ref.No.	Seite Page	Art.-Nr. Ref.No.	Seite Page	Art.-Nr. Ref.No.	Seite Page
12.152.700	1.104	26.109.103	8.3	40.001.304	3.2	40.015.243	3.29
13.053.604	9.21	26.110.001	8.0	40.001.324	3.2	40.015.261	4.4
13.172.200	9.21	26.110.002	8.0	40.001.704	3.3	40.015.501	4.4
13.173.200	9.21	26.110.003	8.0	40.001.724	3.3	40.015.502	3.29
13.562.633	9.21	26.110.101	8.1	40.002.001	4.17	40.015.513	3.29
15.028.102	9.21	26.110.102	8.1	40.002.002	3.25	40.015.521	4.4
15.212.210	4.20	26.110.103	8.1	40.002.003	3.25	40.015.601	4.4
15.562.401	4.18	26.111.101	8.1	40.002.011	4.17	40.015.602	3.29
15.562.402	4.18	26.111.102	8.1	40.002.402	3.25	40.015.613	3.29
15.562.403	9.21	26.111.103	8.1	40.002.403	3.25	40.016.501	4.9
15.597.101	10.4	26.111.202	8.1	40.002.501	4.17	40.017.001	4.15
15.597.601	3.19	26.112.141	8.3	40.002.502	3.25	40.017.002	3.22
17.720.000	9.18	26.112.142	8.3	40.002.503	3.25	40.017.003	3.22
18.813.600	3.15	26.113.101	8.2	40.002.901	2.10	40.017.021	4.15
18.816.502	3.38	26.113.102	8.2	40.002.911	2.10	40.017.022	3.22
18.816.503	3.19	26.113.103	8.2	40.004.014	3.0	40.017.023	3.22
20.017.001	8.3	31.200.401	4.19	40.004.015	3.0	40.017.201	4.15
20.017.102	8.3	31.200.403	4.19	40.004.314	3.0	40.017.202	3.22
20.017.103	8.3	31.206.401	4.19	40.004.315	3.0	40.017.203	3.22
20.105.004	8.4	31.206.403	4.19	40.005.004	3.0	40.018.004	3.10
20.105.504	8.2	31.210.401	4.19	40.005.304	3.0	40.018.014	3.10
21.200.000	4.18	31.221.401	4.21	40.006.004	3.0	40.018.024	3.10
21.200.001	4.18	31.221.403	4.21	40.006.304	3.0	40.018.104	3.10
21.200.004	4.18	31.221.411	4.21	40.007.014	3.1	40.019.001	1.24
21.220.000	4.20	31.221.413	4.21	40.007.015	3.1	40.019.102	1.24
21.220.001	4.20	31.230.401	4.22	40.007.024	3.1	40.019.461	1.24
21.220.100	4.20	31.230.901	4.22	40.007.025	3.1	40.019.501	1.22
21.660.000	3.35	31.236.408	4.22	40.007.314	3.1	40.019.521	1.23
21.660.001	3.35	31.236.902	4.22	40.007.315	3.1	40.020.001	3.39
21.660.100	3.35	31.340.401	3.15	40.007.324	3.1	40.020.002	3.33
26.101.101	8.0	31.340.708	3.15	40.007.325	3.1	40.020.003	3.33
26.101.102	8.0	31.340.709	3.15	40.008.004	5.2	40.023.314	4.13
26.101.103	8.0	31.360.801	3.15	40.010.004	3.4	40.023.901	4.13
26.103.101	8.2	31.370.408	3.15	40.010.104	3.4	40.023.902	3.32
26.103.102	8.2	31.600.407	3.36	40.010.105	3.4	40.023.903	3.32
26.103.103	8.2	31.620.408	3.36	40.010.205	3.5	40.023.921	4.13
26.104.101	8.2	31.650.902	3.38	40.010.214	3.6	40.025.002	1.24
26.104.102	8.2	31.650.904	3.19	40.010.215	3.6	40.025.462	1.24
26.104.103	8.2	31.656.906	3.19	40.010.304	3.5	40.025.502	1.22
26.106.003	8.4	31.660.409	3.35	40.010.904	3.7	40.025.522	1.23
26.106.004	8.4	31.670.002	3.33	40.011.004	3.4	40.026.001	4.14
26.107.104	8.4	31.680.001	3.33	40.011.304	3.5	40.026.002	3.21
26.108.001	8.0	31.690.401	3.34	40.011.904	3.7	40.026.003	3.21
26.108.002	8.0	31.710.400	3.36	40.012.004	3.4	40.026.011	2.8
26.108.003	8.0	31.720.400	3.36	40.012.024	3.2	40.026.012	1.112
26.108.101	8.0	31.770.401	3.34	40.012.304	3.5	40.026.021	4.14
26.108.102	8.0	31.770.403	3.34	40.012.944	3.7	40.026.022	1.112
26.108.103	8.0	31.780.401	3.34	40.013.004	3.4	40.026.031	2.8
26.109.001	8.3	36.300.403	5.3	40.013.304	3.5	40.026.032	1.112
26.109.002	8.3	40.001.004	3.2	40.013.904	3.7	40.026.041	2.9
26.109.003	8.3	40.001.204	3.3	40.015.201	4.4	40.026.042	1.3
26.109.101	8.3	40.001.224	3.3	40.015.202	3.29	40.026.051	2.9
26.109.102	8.3	40.001.304	3.2	40.015.213	3.29	40.026.052	1.2
26.109.103	8.3	40.001.324	3.2	40.015.241	4.4	40.026.061	2.9

Artikelnummernübersicht

Reference Numbers

Art.-Nr. Ref.No.	Seite Page	Art.-Nr. Ref.No.	Seite Page	Art.-Nr. Ref.No.	Seite Page	Art.-Nr. Ref.No.	Seite Page
40.026.071	2.9	40.027.644	5.0	40.048.085	5.11	40.052.232	1.116
40.026.091	4.14	40.031.001	2.11	40.048.093	5.20	40.052.242	1.116
40.026.092	3.21	40.032.001	2.10	40.048.100	5.20	40.053.002	1.42
40.026.093	3.21	40.034.001	4.12	40.048.183	5.21	40.053.202	1.43
40.026.142	1.2	40.034.314	4.12	40.048.193	5.21	40.054.001	1.30
40.026.201	4.14	40.034.501	4.12	40.048.200	1.116	40.054.003	1.30
40.026.202	3.21	40.035.003	5.11	40.048.203	5.17	40.054.022	1.30
40.026.203	3.21	40.035.203	5.11	40.048.213	5.17	40.054.032	1.30
40.026.211	2.8	40.037.003	5.7	40.048.223	5.17	40.054.501	1.31
40.026.212	1.112	40.037.013	5.7	40.048.233	5.17	40.054.503	1.31
40.026.222	1.112	40.037.023	5.7	40.048.243	5.18	40.054.522	1.31
40.026.231	2.8	40.037.033	5.7	40.048.253	5.18	40.054.532	1.31
40.026.232	1.112	40.037.043	5.7	40.048.263	5.18	40.055.001	1.16
40.026.241	2.9	40.037.053	5.7	40.048.273	5.18	40.055.003	1.16
40.026.242	1.3	40.044.001	4.16	40.048.283	5.20	40.055.201	1.16
40.026.251	2.9	40.044.002	3.23	40.048.293	5.20	40.055.203	1.16
40.026.252	1.2	40.044.003	3.23	40.048.323	5.20	40.056.003	5.6
40.026.261	2.9	40.044.011	4.16	40.048.333	5.20	40.056.012	3.28
40.026.271	2.9	40.044.201	4.16	40.048.383	5.21	40.056.043	5.6
40.026.292	3.21	40.044.202	3.23	40.048.393	5.21	40.056.073	5.6
40.026.293	3.21	40.044.203	3.23	40.048.423	5.20	40.056.273	5.6
40.026.311	4.14	40.044.211	4.16	40.048.433	5.20	40.057.001	1.14
40.026.312	2.13	40.044.402	3.23	40.048.603	5.19	40.057.002	1.14
40.026.314	4.14	40.044.403	3.23	40.048.613	5.19	40.057.012	1.15
40.026.322	1.113	40.044.502	3.23	40.048.623	5.19	40.057.013	1.15
40.026.332	1.113	40.044.503	3.23	40.048.633	5.19	40.057.032	1.14
40.026.342	1.3	40.046.003	5.10	40.048.703	5.19	40.057.212	1.15
40.026.412	2.13	40.046.013	5.10	40.048.713	5.19	40.057.213	1.15
40.026.422	1.113	40.046.203	5.10	40.048.723	5.19	40.057.502	1.14
40.026.432	1.113	40.046.213	5.10	40.048.733	5.19	40.057.700	1.117
40.026.442	1.3	40.046.903	5.10	40.049.001	4.0	40.057.911	1.14
40.026.501	1.112	40.046.913	5.10	40.049.021	4.0	40.058.002	1.32
40.026.503	1.112	40.047.003	5.8	40.049.501	2.7	40.058.012	1.32
40.026.521	1.112	40.047.012	1.4	40.049.521	2.7	40.058.911	1.32
40.026.523	1.112	40.047.013	5.8	40.049.801	2.7	40.059.001	1.17
40.026.542	1.2	40.047.023	5.8	40.049.821	2.7	40.059.003	1.17
40.026.601	1.113	40.047.033	5.8	40.050.001	1.42	40.059.201	1.17
40.026.621	1.113	40.047.043	5.8	40.050.201	1.43	40.059.203	1.17
40.026.642	1.2	40.047.053	5.8	40.050.212	1.42	40.059.700	1.117
40.026.652	1.1	40.047.512	1.4	40.050.501	1.42	40.060.003	5.23
40.026.672	1.1	40.047.611	1.5	40.051.001	1.29	40.060.013	5.23
40.026.701	2.8	40.047.612	1.5	40.051.002	1.29	40.060.023	5.23
40.026.721	2.8	40.047.711	1.5	40.052.002	3.20	40.060.033	5.23
40.026.742	1.2	40.047.712	1.5	40.052.003	3.20	40.060.043	5.24
40.026.752	1.1	40.048.000	5.20	40.052.012	3.20	40.060.053	5.24
40.026.801	2.8	40.048.003	5.17	40.052.013	3.20	40.060.063	5.24
40.026.842	1.2	40.048.013	5.17	40.052.022	1.116	40.060.073	5.24
40.026.852	1.1	40.048.023	5.17	40.052.032	1.116	40.060.083	5.25
40.026.942	1.2	40.048.033	5.17	40.052.042	1.116	40.060.093	5.25
40.027.004	5.0	40.048.043	5.18	40.052.202	3.20	40.060.203	5.23
40.027.044	5.0	40.048.053	5.18	40.052.203	3.20	40.060.213	5.23
40.027.214	5.0	40.048.063	5.18	40.052.212	3.20	40.060.223	5.23
40.027.504	5.4	40.048.073	5.18	40.052.213	3.20	40.060.233	5.23
40.027.544	5.4	40.048.083	5.20	40.052.222	1.116	40.060.243	5.24

Artikelnummernübersicht

Reference Numbers

Art.-Nr. Ref.No.	Seite Page	Art.-Nr. Ref.No.	Seite Page	Art.-Nr. Ref.No.	Seite Page	Art.-Nr. Ref.No.	Seite Page
40.060.253	5.24	40.064.283	5.16	40.118.102	3.17	40.153.105	3.14
40.060.263	5.24	40.064.293	5.16	40.118.103	3.16	40.153.205	3.14
40.060.273	5.24	40.064.323	5.16	40.118.103	3.16	40.155.001	4.10
40.060.283	5.25	40.064.333	5.16	40.118.103	3.17	40.155.021	4.10
40.060.293	5.25	40.064.423	5.16	40.120.001	4.13	40.155.621	4.10
40.060.323	5.25	40.064.433	5.16	40.120.002	3.32	40.157.001	4.8
40.060.333	5.25	40.065.001	4.1	40.120.003	3.32	40.157.021	4.8
40.060.423	5.25	40.065.002	3.28	40.120.021	4.13	40.157.031	4.8
40.060.433	5.25	40.065.003	3.28	40.123.011	4.27	40.157.101	4.8
40.061.001	4.16	40.065.011	4.1	40.123.013	3.37	40.157.204	4.8
40.061.002	3.24	40.065.013	3.28	40.123.101	4.27	40.157.214	4.8
40.061.003	3.24	40.065.201	4.1	40.124.011	4.27	40.157.221	4.8
40.061.011	4.16	40.065.202	3.28	40.125.011	4.27	40.157.224	4.8
40.061.022	3.24	40.065.203	3.28	40.126.001	3.39	40.157.314	4.8
40.061.033	3.24	40.067.001	2.10	40.126.003	3.39	40.157.501	4.6
40.063.001	4.2	40.068.003	5.9	40.127.004	3.17	40.157.511	4.6
40.063.002	3.26	40.068.043	5.9	40.128.001	4.26	40.157.514	4.8
40.063.003	3.26	40.069.001	2.10	40.128.031	4.26	40.157.521	4.6
40.063.011	4.2	40.071.001	2.10	40.128.101	4.26	40.157.531	4.6
40.063.012	3.26	40.072.004	5.1	40.128.204	4.26	40.157.541	4.6
40.063.013	3.26	40.100.004	3.11	40.128.254	3.31	40.158.004	3.14
40.063.021	4.2	40.100.024	3.11	40.129.001	4.27	40.159.004	3.14
40.063.071	4.3	40.100.504	3.11	40.129.021	4.27	40.162.002	2.6
40.063.072	3.27	40.101.004	3.18	40.129.031	4.27	40.162.003	2.6
40.063.073	3.27	40.101.104	3.18	40.130.002	2.6	40.163.000	3.31
40.063.201	4.3	40.102.004	3.18	40.130.003	2.6	40.163.502	3.31
40.063.202	3.27	40.103.004	3.18	40.132.002	2.6	40.163.602	3.31
40.063.203	3.27	40.104.004	3.18	40.132.003	2.6	40.164.513	3.31
40.063.314	4.2	40.104.104	3.18	40.133.003	3.37	40.164.523	3.31
40.063.601	4.3	40.107.004	3.12	40.133.103	3.37	40.165.004	5.3
40.063.602	3.26	40.107.104	3.12	40.134.003	3.38	40.165.404	5.1
40.063.603	3.26	40.107.105	3.12	40.137.504	3.16	40.165.604	5.1
40.064.003	5.14	40.107.205	3.13	40.137.514	3.16	40.166.004	5.3
40.064.003	5.22	40.107.304	3.13	40.138.001	4.28	40.166.404	5.2
40.064.013	5.14	40.108.004	3.12	40.138.002	3.38	40.167.004	3.8
40.064.013	5.22	40.108.304	3.13	40.138.003	3.38	40.167.104	3.8
40.064.023	5.14	40.109.004	3.12	40.144.004	5.2	40.167.304	3.8
40.064.023	5.22	40.109.304	3.13	40.145.001	4.28	40.168.004	3.8
40.064.033	5.14	40.110.004	3.12	40.145.101	4.28	40.168.304	3.8
40.064.033	5.22	40.110.304	3.13	40.146.001	4.28	40.169.004	3.8
40.064.043	5.15	40.113.004	5.2	40.147.003	3.38	40.170.004	3.18
40.064.053	5.15	40.114.204	5.2	40.149.002	2.6	40.170.104	3.18
40.064.083	5.16	40.114.244	5.2	40.149.003	2.6	40.171.004	3.18
40.064.093	5.16	40.116.004	3.16	40.149.202	1.26	40.180.001	4.23
40.064.203	5.14	40.116.102	3.16	40.149.222	1.26	40.180.011	4.23
40.064.203	5.22	40.116.103	3.16	40.149.402	1.25	40.180.204	4.23
40.064.213	5.14	40.116.105	3.16	40.149.403	1.25	40.180.214	4.23
40.064.213	5.22	40.116.205	3.16	40.150.001	4.25	40.182.004	5.5
40.064.223	5.14	40.117.004	3.17	40.150.501	4.25	40.182.104	5.5
40.064.223	5.22	40.117.102	3.17	40.151.601	4.13	40.185.002	3.33
40.064.233	5.14	40.117.103	3.17	40.152.001	4.24	40.185.003	3.33
40.064.233	5.22	40.118.004	3.16	40.152.101	4.24	40.187.001	4.24
40.064.243	5.15	40.118.102	3.16	40.153.004	3.14	40.187.101	4.24
40.064.253	5.15	40.118.102	3.16	40.153.104	3.14	40.188.004	3.14

Artikelnummernübersicht

Reference Numbers

Art.-Nr. Ref.No.	Seite Page	Art.-Nr. Ref.No.	Seite Page	Art.-Nr. Ref.No.	Seite Page	Art.-Nr. Ref.No.	Seite Page
40.189.004	3.9	40.206.004	1.79	40.223.203	1.61	40.238.212	1.48
40.189.304	3.9	40.206.102	1.79	40.223.312	1.59	40.239.011	1.81
40.190.004	3.9	40.207.112	1.52	40.223.313	1.59	40.239.012	1.81
40.191.004	3.9	40.207.312	1.53	40.224.011	1.108	40.239.014	1.81
40.194.001	4.9	40.207.313	1.53	40.224.012	1.108	40.239.111	1.81
40.194.003	3.32	40.207.322	1.52	40.224.013	1.108	40.239.114	1.81
40.194.011	4.9	40.207.323	1.52	40.224.111	1.108	40.241.112	1.78
40.194.201	4.9	40.207.512	1.55	40.224.112	1.108	40.241.211	1.78
40.194.301	4.23	40.207.513	1.55	40.224.113	1.108	40.241.212	1.78
40.194.314	4.9	40.207.612	1.57	40.225.001	1.83	40.242.011	1.100
40.194.601	4.9	40.207.613	1.57	40.225.102	1.83	40.242.012	1.100
40.194.611	4.9	40.207.811	1.56	40.225.201	1.83	40.242.112	1.100
40.196.001	4.25	40.207.812	1.56	40.225.203	1.83	40.242.611	1.100
40.197.201	4.5	40.207.813	1.56	40.226.011	1.91	40.242.612	1.100
40.197.213	3.30	40.209.003	1.72	40.226.012	1.91	40.243.001	1.73
40.197.221	4.5	40.209.013	1.72	40.226.013	1.91	40.243.102	1.73
40.197.501	4.5	40.209.103	1.72	40.226.112	1.91	40.243.112	1.73
40.197.511	4.5	40.209.113	1.72	40.226.113	1.92	40.243.202	1.73
40.197.512	3.30	40.211.011	1.77	40.226.211	1.91	40.243.203	1.73
40.197.513	3.30	40.211.012	1.77	40.226.212	1.91	40.244.001	1.7
40.197.521	4.5	40.211.111	1.77	40.226.213	1.91	40.244.501	1.7
40.197.531	4.5	40.211.112	1.77	40.226.411	1.92	40.245.011	1.102
40.198.001	4.25	40.211.113	1.77	40.226.412	1.92	40.245.012	1.102
40.199.002	10.5	40.211.114	1.77	40.227.011	1.106	40.245.111	1.102
40.201.001	1.80	40.211.211	1.77	40.227.012	1.106	40.245.112	1.102
40.202.001	1.80	40.211.212	1.77	40.227.013	1.106	40.246.112	1.95
40.202.003	1.80	40.211.311	1.77	40.227.111	1.106	40.246.211	1.95
40.202.102	1.80	40.211.312	1.77	40.227.112	1.106	40.246.212	1.95
40.202.601	1.28	40.217.002	1.70	40.228.012	1.68	40.246.213	1.95
40.202.701	1.26	40.217.102	1.70	40.228.013	1.68	40.246.311	1.96
40.202.721	1.26	40.217.202	1.70	40.228.112	1.68	40.246.312	1.96
40.202.761	1.26	40.217.302	1.70	40.230.212	1.68	40.246.313	1.96
40.202.801	1.27	40.218.011	1.71	40.230.213	1.68	40.246.603	1.49
40.202.821	1.27	40.218.012	1.71	40.231.112	1.69	40.247.011	1.110
40.202.911	1.25	40.218.013	1.71	40.231.212	1.69	40.247.012	1.110
40.204.001	1.74	40.218.111	1.71	40.231.213	1.69	40.247.013	1.110
40.204.002	1.74	40.218.112	1.71	40.233.011	1.109	40.247.112	1.110
40.204.003	1.74	40.219.111	1.66	40.233.012	1.109	40.247.112	1.110
40.204.004	1.74	40.219.112	1.66	40.233.013	1.109	40.247.113	1.110
40.204.011	1.75	40.220.002	1.67	40.233.111	1.109	40.247.311	1.111
40.204.012	1.75	40.220.003	1.67	40.233.112	1.109	40.247.312	1.111
40.204.013	1.75	40.220.202	1.66	40.233.113	1.109	40.247.313	1.111
40.204.102	1.74	40.220.203	1.66	40.233.121	1.104	40.248.011	1.107
40.204.112	1.75	40.220.912	1.25	40.233.123	1.104	40.248.012	1.107
40.205.006	5.5	40.222.013	1.82	40.233.311	1.109	40.248.013	1.107
40.205.008	5.3	40.222.014	1.82	40.233.312	1.109	40.248.112	1.107
40.205.106	5.5	40.222.015	1.82	40.233.313	1.109	40.251.012	1.65
40.205.116	5.4	40.222.112	1.82	40.233.411	1.104	40.251.013	1.65
40.205.118	5.1	40.222.115	1.82	40.233.413	1.104	40.251.112	1.65
40.205.300	5.2	40.222.115	1.82	40.237.111	1.84	40.253.012	1.51
40.205.506	5.4	40.223.012	1.60	40.237.112	1.84	40.253.013	1.51
40.205.508	5.1	40.223.013	1.60	40.237.611	1.84	40.253.015	1.51
40.206.002	1.79	40.223.112	1.59	40.237.612	1.84	40.253.111	1.51
40.206.003	1.79	40.223.202	1.61	40.238.211	1.48	40.253.112	1.51

Artikelnummernübersicht

Reference Numbers

Art.-Nr. Ref.No.	Seite Page	Art.-Nr. Ref.No.	Seite Page	Art.-Nr. Ref.No.	Seite Page	Art.-Nr. Ref.No.	Seite Page
40.253.121	1.101	40.258.012	1.8	40.291.313	1.46	40.460.603	6.3
40.253.122	1.101	40.259.012	1.62	40.292.011	1.39	40.460.802	2.0
40.253.131	1.54	40.259.013	1.62	40.292.012	1.39	40.460.903	2.0
40.253.132	1.54	40.259.112	1.62	40.292.211	1.40	40.460.903	6.18
40.253.151	1.58	40.260.001	1.9	40.292.212	1.40	40.466.003	2.0
40.253.151	1.65	40.260.012	1.9	40.292.311	1.41	40.466.003	6.18
40.253.152	1.58	40.268.011	1.105	40.292.312	1.41	40.467.003	6.9
40.253.152	1.65	40.268.012	1.105	40.292.511	1.36	40.467.503	6.8
40.253.211	1.101	40.268.111	1.105	40.292.512	1.36	40.467.523	6.9
40.253.212	1.101	40.268.112	1.105	40.292.611	1.37	40.467.773	6.8
40.253.312	1.54	40.275.111	1.97	40.292.612	1.37	40.467.783	6.8
40.253.313	1.54	40.275.112	1.97	40.292.711	1.38	40.468.003	6.12
40.253.315	1.54	40.275.411	1.97	40.292.712	1.38	40.468.013	6.13
40.253.412	1.54	40.275.412	1.97	40.294.012	1.11	40.468.015	6.13
40.253.413	1.54	40.277.012	1.19	40.294.212	1.11	40.468.073	6.12
40.253.415	1.54	40.278.002	1.34	40.295.001	1.35	40.468.083	6.12
40.253.512	1.65	40.278.012	1.34	40.295.002	1.35	40.469.003	6.4
40.253.513	1.65	40.279.011	1.76	40.295.111	1.35	40.469.013	6.5
40.253.712	1.58	40.279.012	1.76	40.295.112	1.35	40.469.023	6.6
40.253.713	1.58	40.279.112	1.76	40.296.111	1.85	40.469.073	6.4
40.255.112	1.86	40.280.011	1.44	40.296.112	1.85	40.469.083	6.4
40.255.211	1.86	40.280.012	1.44	40.296.211	1.85	40.469.303	6.7
40.255.212	1.86	40.280.013	1.45	40.296.212	1.85	40.469.403	6.7
40.255.213	1.86	40.280.014	1.45	40.297.211	1.47	40.469.773	6.5
40.255.311	1.87	40.282.012	1.18	40.297.213	1.47	40.469.783	6.5
40.255.312	1.87	40.282.013	1.18	40.305.200	1.118	40.469.903	6.6
40.255.321	1.87	40.282.014	1.18	40.305.204	1.83	40.470.003	6.10
40.255.322	1.87	40.282.212	1.18	40.305.214	1.83	40.470.023	6.11
40.255.400	1.90	40.283.001	1.33	40.305.224	1.83	40.470.073	6.10
40.255.411	1.89	40.283.002	1.33	40.305.600	1.118	40.470.083	6.10
40.255.412	1.89	40.285.011	1.0	40.305.700	1.118	40.472.003	6.1
40.255.511	1.88	40.285.012	1.0	40.405.003	6.19	40.472.303	6.2
40.255.512	1.88	40.287.001	1.20	40.407.003	6.19	40.472.403	6.2
40.255.521	1.88	40.287.003	1.20	40.410.113	6.20	40.472.503	6.1
40.255.522	1.88	40.287.301	1.21	40.410.213	6.20	40.473.003	6.0
40.255.600	1.90	40.287.303	1.21	40.414.003	6.17	40.473.503	6.0
40.255.611	1.88	40.287.911	2.12	40.417.003	6.17	40.475.003	5.11
40.255.612	1.88	40.288.001	1.13	40.424.003	2.0	40.501.001	7.13
40.255.700	1.90	40.288.012	1.12	40.424.003	6.18	40.501.101	7.13
40.255.800	1.90	40.288.201	1.13	40.425.003	6.14	40.501.500	7.13
40.255.900	1.90	40.288.212	1.12	40.426.003	6.9	40.502.001	7.13
40.256.011	1.98	40.290.001	1.93	40.429.003	6.14	40.503.001	7.13
40.256.012	1.98	40.290.002	1.93	40.429.303	6.14	40.504.001	7.13
40.256.111	1.98	40.290.011	1.94	40.429.503	6.15	40.505.001	7.9
40.256.112	1.98	40.290.012	1.94	40.429.903	6.14	40.505.011	7.9
40.256.211	1.99	40.290.111	1.93	40.430.002	6.17	40.506.001	7.9
40.256.212	1.99	40.290.112	1.93	40.432.003	6.19	40.506.011	7.9
40.256.311	1.98	40.290.211	1.49	40.433.103	6.16	40.507.501	7.10
40.256.312	1.98	40.290.212	1.49	40.433.503	6.16	40.508.601	7.10
40.256.411	1.99	40.290.311	1.50	40.433.703	6.16	40.508.901	7.10
40.256.412	1.99	40.290.312	1.50	40.448.003	6.20	40.515.001	7.16
40.257.012	1.63	40.291.011	1.46	40.454.003	6.20	40.515.011	7.16
40.257.013	1.63	40.291.013	1.46	40.455.003	6.20	40.515.201	7.16
40.257.112	1.63	40.291.311	1.46	40.460.003	6.3	40.515.211	7.16

Artikelnummernübersicht

Reference Numbers

Art.-Nr. Ref.No.	Seite Page	Art.-Nr. Ref.No.	Seite Page	Art.-Nr. Ref.No.	Seite Page	Art.-Nr. Ref.No.	Seite Page
40.515.701	7.16	40.607.002	2.13	50.030.000	5.13	50.090.000	10.0
40.515.901	7.16	40.616.501	7.20	50.033.000	7.15	50.090.100	10.0
40.521.501	7.11	40.617.501	7.20	50.034.000	7.15	50.090.450	10.1
40.521.511	7.11	40.618.501	7.20	50.035.000	7.15	50.090.750	10.1
40.523.501	7.11	40.619.501	7.20	50.042.200	9.12	50.090.850	10.1
40.525.500	7.12	40.621.501	7.20	50.042.408	9.2	50.090.950	10.1
40.551.001	7.2	40.640.501	7.18	50.043.000	9.12	50.105.005	10.3
40.551.101	7.2	40.641.501	7.18	50.044.001	10.3	50.105.015	10.3
40.551.201	7.2	40.642.501	7.18	50.045.100	9.13	50.120.000	1.51
40.551.301	7.2	40.643.501	7.18	50.045.200	9.13	50.125.000	9.10
40.551.401	7.3	40.665.701	7.6	50.045.300	9.13	50.125.012	9.10
40.551.501	7.3	40.665.801	7.6	50.047.000	9.21	50.138.000	10.3
40.551.601	7.3	40.665.901	7.6	50.047.001	9.20	50.139.012	9.10
40.552.501	7.10	40.676.001	7.14	50.047.002	9.20	50.139.024	9.10
40.555.001	7.12	40.676.101	7.14	50.047.003	9.21	50.140.012	9.1
40.555.101	7.12	40.677.001	7.14	50.048.000	9.17	50.140.024	9.1
40.557.001	7.12	40.678.001	7.14	50.048.100	9.16	50.140.512	9.0
40.558.001	7.12	40.694.001	7.8	50.049.000	9.17	50.140.513	9.0
40.559.001	7.12	40.694.011	7.8	50.049.100	9.16	50.140.624	9.0
40.565.201	7.14	40.694.201	7.8	50.049.400	9.14	50.140.625	9.0
40.570.001	7.4	40.694.211	7.8	50.050.000	9.17	50.140.712	9.1
40.570.101	7.4	40.703.012	1.10	50.050.100	9.16	50.140.724	9.1
40.570.201	7.4	40.703.212	1.10	50.051.000	9.12	50.141.012	9.10
40.570.301	7.4	50.001.000	5.13	50.051.815	9.2	50.141.024	9.10
40.570.401	7.5	50.001.000	9.18	50.051.837	9.2	50.141.212	9.9
40.570.501	7.5	50.002.000	9.18	50.051.845	9.4	50.141.500	9.9
40.570.601	7.5	50.003.100	9.19	50.051.847	9.3	50.142.000	9.11
40.589.001	7.8	50.003.200	9.19	50.051.865	9.6	50.142.100	9.11
40.589.011	7.8	50.003.300	9.19	50.051.897	9.2	50.142.200	9.11
40.589.021	7.9	50.003.400	9.19	50.052.000	10.2	50.173.000	9.7
40.590.001	7.7	50.003.500	9.19	50.059.100	9.20	50.173.100	9.8
40.590.101	7.7	50.003.600	9.19	50.059.200	9.20	50.307.012	7.12
40.591.001	7.7	50.005.000	9.12	50.062.001	1.52	50.307.024	7.12
40.592.001	7.7	50.006.000	9.12	50.067.007	7.14	58.109.807	9.15
40.593.001	7.7	50.007.112	5.13	50.068.000	9.20	58.109.808	9.15
40.594.001	7.10	50.007.115	5.13	50.068.100	9.20	58.109.820	9.15
40.596.001	7.11	50.007.200	5.13	50.068.200	9.20	58.204.000	9.14
40.597.001	7.17	50.007.400	5.13	50.071.000	9.20	58.204.001	9.14
40.597.201	7.17	50.007.600	5.13	50.071.100	9.20	68.500.001	10.4
40.598.001	7.11	50.007.800	5.13	50.071.200	9.20	68.500.002	10.4
40.599.001	7.0	50.009.400	5.13	50.071.300	9.20	68.500.003	10.4
40.599.011	7.0	50.009.800	5.13	50.079.000	9.19	68.500.004	10.4
40.599.201	7.0	50.011.000	7.15	50.079.100	9.19	68.500.005	10.4
40.599.211	7.0	50.012.000	7.15	50.079.200	9.19	68.500.006	10.4
40.599.301	7.0	50.012.100	7.15	50.079.300	9.19	90.152.001	4.24
40.599.311	7.0	50.013.000	7.15	50.079.400	9.19	90.155.006	4.11
40.599.701	7.1	50.013.100	7.15	50.079.500	9.19	90.155.008	4.11
40.599.801	7.1	50.014.000	7.15	50.079.600	9.19	90.155.010	4.11
40.599.901	7.1	50.014.100	7.15	50.079.900	9.19	90.155.021	4.10
40.600.001	7.19	50.015.000	10.5	50.080.000	10.3	90.157.506	4.7
40.601.001	7.19	50.016.000	10.2	50.081.200	10.3	90.157.508	4.7
40.602.001	7.19	50.017.000	10.5	50.081.867	9.5	90.157.510	4.7
40.603.001	7.19	50.018.000	10.5	50.083.000	10.2	90.187.001	4.24
40.606.002	2.13	50.024.000	7.2	50.086.000	7.12		

Artikel-Nr. <i>Reference-No.</i>	Notizen <i>Notes</i>

PROPLAST
FAHRZEUGBELEUCHTUNG

Dieselstraße 17
61191 Rosbach, Hessen
Deutschland
Telefon: +49 6003 934 - 0
Telefax: +49 6003 934 - 19
E-Mail: info@proplast-online.de

www.proplast-online.de



Art. 40 200 200